

For air-conditioner fan motor

3-Phase Brushless Fan Motor Controller

BD62011AFS

● General Description

This controller synthesizes the optimal driving signal from hall sensor signals, and outputs the synthesized signal to control the external level shifter and power transistor. The replacement is also easy because of its pin compatibility with BD62012AFS and BD62014AFS. This controller provides optimum motor drive for a wide variety of applications, and enables motor unit standardization.

● Features

- 180° sinusoidal commutation logic
- PWM control (Upper and lower arm switching)
- Phase control supported from 0° to +40° at 1° intervals
- Rotational direction switch
- FG signal output with pulse number switch (4 or 12)
- VREG output (5V/30mA)
- Protection circuits provided: OCP, UVLO, TSD, MLP and the external fault input (FIB)

● Applications

- Air conditioners; air cleaners; water pumps; dishwashers; washing machines
- General OA equipment

● Key Specifications

- Supply voltage range: 10V to 18V
- Duty control voltage range: 2.1V to 5.4V
- Phase control range: 0° to 40°
- Operating temperature: -40°C to 110°C
- Junction Temperature: +150°C
- Power dissipation: 1.0W

● Package

SSOP-A24

W (Typ.) x D (Typ.) x H (Max.)
10.00 mm x 7.80 mm x 2.10 mm



● Typical Application Circuit

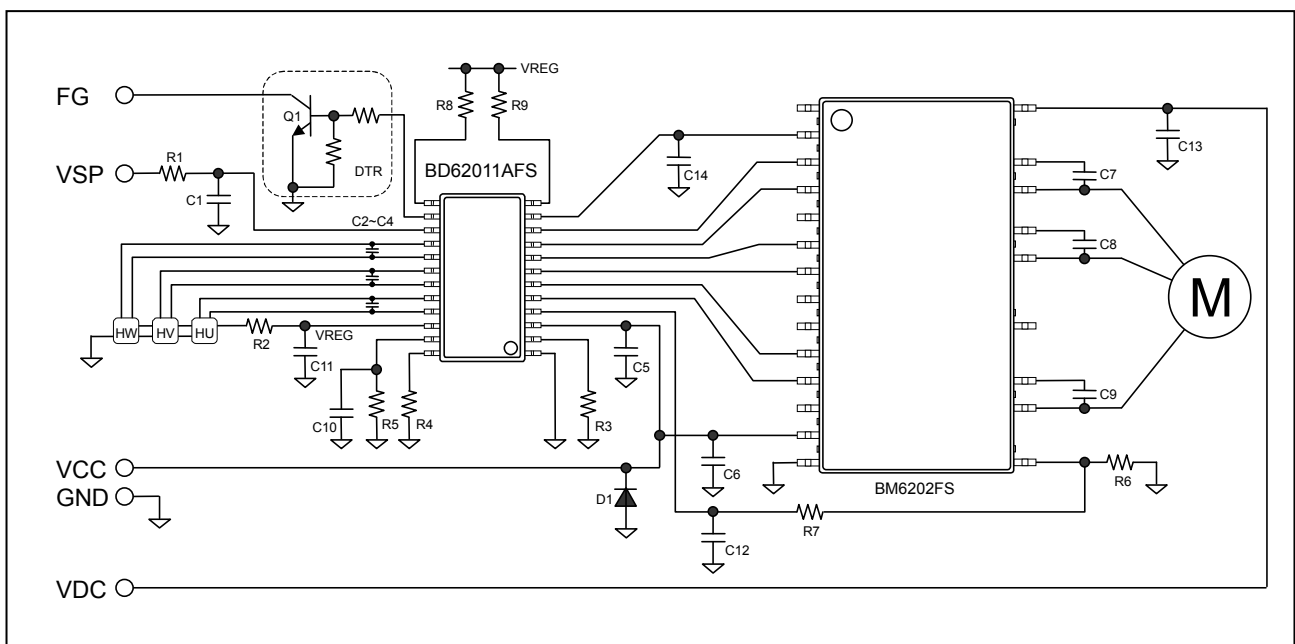

Figure 1. Application circuit example - BD62011AFS & BM6202FS

● Block Diagram and Pin Configuration

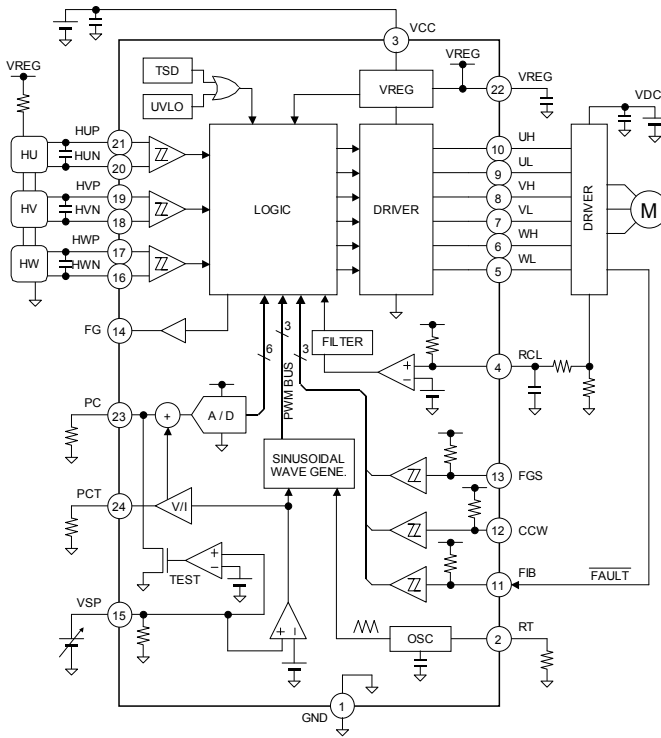

Figure 2. Block diagram

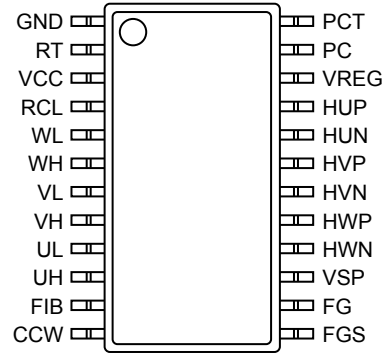

Figure 3. Pin configuration

● Pin Descriptions

Pin	Name	Function	Pin	Name	Function
1	GND	Signal ground	24	PCT	VSP offset voltage output pin
2	RT	Carrier frequency setting pin	23	PC	Phase control input pin
3	VCC	Power supply	22	VREG	Regulator output
4	RCL	Over current sense pin	21	HUP	Hall input pin phase U+
5	WL	Low side driver output phase W	20	HUN	Hall input pin phase U-
6	WH	High side driver output phase W	19	HVP	Hall input pin phase V+
7	VL	Low side driver output phase V	18	HVN	Hall input pin phase V-
8	VH	High side driver output phase V	17	HWP	Hall input pin phase W+
9	UL	Low side driver output phase U	16	HWN	Hall input pin phase W-
10	UH	High side driver output phase U	15	VSP	Duty control voltage input pin
11	FIB	External fault input (Low active)	14	FG	FG signal output
12	CCW	Direction switch (H:CCW)	13	FGS	FG pulse # switch (H:12, L:4)

● Functional Descriptions

1) Commutation logic

When the hall cycle is about 5-Hz or less (e.g. when the motor starts up), the commutation mode is 120° square wave drive with upper and lower switching (no lead angle). The controller monitors the hall cycle, and switches to 180° sinusoidal commutation drive when the hall cycle reaches or exceeds about 5-Hz over four consecutive cycles. Refer to the timing charts in figures 7 and 8.

Table 1. 120° commutation (Six-state) truth table (CW)

HU	HV	HW	UH	VH	WH	UL	VL	WL
H	L	H	L	PWM	L	H	$\overline{\text{PWM}}$	L
H	L	L	L	L	PWM	H	L	$\overline{\text{PWM}}$
H	H	L	L	L	PWM	L	H	$\overline{\text{PWM}}$
L	H	L	PWM	L	L	$\overline{\text{PWM}}$	H	L
L	H	H	PWM	L	L	$\overline{\text{PWM}}$	L	H
L	L	H	L	PWM	L	L	$\overline{\text{PWM}}$	H

2) Duty control

The switching duty can be controlled by forcing DC voltage with value from V_{SPMIN} to V_{SPMAX} to the VSP pin. When the VSP voltage is higher than V_{SPTST} , the controller forces PC pin voltage to ground (Testing mode, maximum duty and no lead angle). The VSP pin is pulled down internally by a 200 kΩ resistor. Therefore, note the impedance when setting the VSP voltage with a resistance voltage divider.

3) Carrier frequency setting

The carrier frequency setting can be freely adjusted by connecting an external resistor between the RT pin and ground. The RT pin is biased to a constant voltage, which determines the charge current to the internal capacitor. Carrier frequencies can be set within a range from about 16 kHz to 50 kHz. Refer to the formula to the right.

$$F_{OSC} [\text{kHz}] = \frac{400}{R_T [\text{k}\Omega]}$$

4) FG signal output

The number of FG output pulses can be switched in accordance with the number of poles and the rotational speed of the motor. The FG signal is output from the FG pin. The 12-pulse signal is generated from the three hall signals (exclusive NOR), and the 4-pulse signal is the same as hall U signal. It is recommended to pull up FGS pin to VREG voltage when malfunctioning because of the noise.

FGS	No. of pulse
H	12
L	4

5) Direction of motor rotation setting

The direction of rotation may be switched by the CCW pin. When CCW pin is "H" or open, the motor rotates at CCW direction. When the real direction is different from the setting, the commutation mode is 120° square wave drive (no lead angle). It is recommended to pull up CCW pin to VREG voltage when malfunctioning because of the noise.

CCW	Direction
H	CCW
L	CW

6) Hall signal comparator

The hall comparator provides voltage hysteresis to prevent noise malfunctions. The bias current to the hall elements should be set to the input voltage amplitude from the element, at a value higher than the minimum input voltage, $V_{HALLMIN}$. We recommend connecting a ceramic capacitor with value from 100 pF to 0.01 μF, between the differential input pins of the hall comparator. Note that the bias to hall elements must be set within the common mode input voltage range V_{HALLCM} .

7) Output duty pulse width limiter

Pulse width duty is controlled during PWM switching in order to ensure the operation of external power transistor. The controller doesn't output pulse of less than T_{MIN} (0.8 μ s minimum). Dead time is forcibly provided to prevent external power transistors to turn-on simultaneously in upper and lower side in driver output (for example, UH and UL) of each arm. This will not overlap the minimum time T_{DT} (1.6 μ s minimum). Because of this, the maximum duty of 120° square wave drive at start up is 90% (typical).

8) Phase control setting

The driving signal phase can be advanced to the hall signal for phase control. The lead angle is set by forcing DC voltage to the PC pin. The input voltage is converted digitally by a 6-bit A/D converter, in which internal VREG voltage is assumed to be full-scale, and the converted data is processed by a logic circuit. The lead angle can be set from 0° to +40° at 1° intervals, and updated fourth hall cycle of phase W falling edge. Phase control function only operates at sinusoidal commutation mode. However, the controller forces PC pin voltage to ground (no lead angle) during testing mode. The VSP offset voltage (Figure 29) is buffered to PCT pin, to connect an external resistor between PCT pin and ground. The internal bias current is determined by PCT voltage and the resistor value - V_{PCT} / R_{PCT} -, and mixed to PC pin. As a result, the lead angle setting is followed with the duty control voltage, and the performance of the motor can be improved. Please select the R_{PCT} value from 50 k Ω to 200 k Ω in the range on the basis of 100 k Ω , because the PCT pin current capability is a 100 μ A or less.

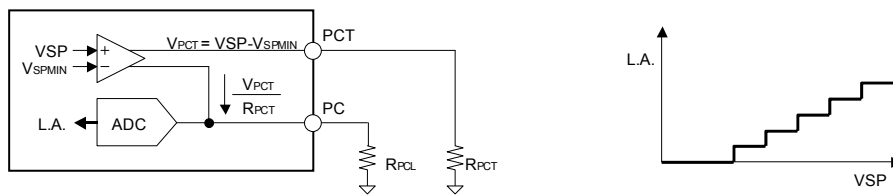

Figure 4. Phase control setting example 1

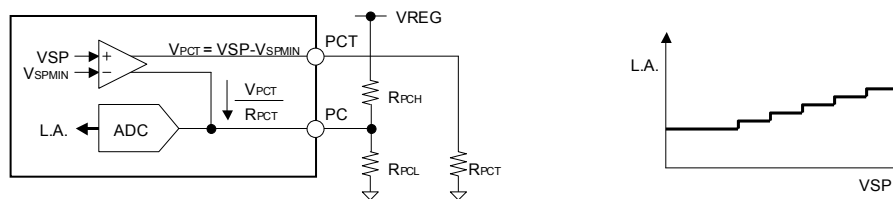

Figure 5. Phase control setting example 2

9) Overcurrent protection (OCP) circuit

The over current protection circuit can be activated by connecting a low value resistor for current detection between the external output stage ground and the controller IC ground. When the RCL pin voltage reaches or surpasses the threshold value, the controller forces all the upper switching arm inputs low (UH, VH, WH = L, L, L), thus initiating the overcurrent protection operation. When the RCL pin voltage swings below the ground, it is recommended to insert a resistor - 1.5 k Ω or more - between RCL pin and current detection resistor to prevent malfunction. Since this protection circuit is not a latch type, it returns to normal operation - synchronizing with the carrier frequency - once the RCL pin voltage falls below the threshold voltage. A filter is built into the overcurrent detection circuit to prevent malfunctions, and does not activate when a short pulse of less than T_{RCL} is present at the input.

10) Under voltage lock out (UVLO) circuit

To secure the lowest power supply voltage necessary to operate the controller, and to prevent under voltage malfunctions, an UVLO circuit is built into this controller. When the power supply voltage falls to V_{UVL} or below, the controller forces all driver outputs low. When the voltage rises to V_{UVH} or above, the UVLO circuit ends the lock out operation and returns the chip to normal operation.

The voltage monitor circuit (4.0V nominal) is built-in for the VREG voltage. Therefore, the UVLO circuit does not release operation when the VREG voltage rising is delayed behind the VCC voltage rising even if VCC voltage becomes V_{UVH} or more.

11) Thermal shutdown (TSD) circuit

The TSD circuit operates when the junction temperature of the controller exceeds the preset temperature (175°C nominal). At this time, the controller forces all driver outputs low. Since thermal hysteresis is provided in the TSD circuit, the chip returns to normal operation when the junction temperature falls below the preset temperature (150°C nominal). The TSD circuit is designed only to shut the IC off to prevent thermal runaway. It is not designed to protect the IC or guarantee its operation in the presence of extreme heat. Do not continue to use the IC after the TSD circuit is activated, and do not use the IC in an environment where activation of the circuit is assumed.

12) Motor lock protection (MLP) circuit

When the controller detects the motor locking during fixed time of 4 seconds nominal when each edge of the hall signal doesn't input either, the controller forces all driver outputs low under a fixed time 20 seconds nominal, and self-returns to normal operation. This circuit is enabled if the voltage force to VSP is over the duty minimum voltage V_{SPMIN} , and note that the motor cannot start up when the controller doesn't detect the motor rotation by the minimum duty control.

13) External fault signal input pin (FIB pin, low active)

The FIB pin can force all controller driver outputs low at any time. The FIB pin is pulled up to VREG internally by a 100 kΩ resistor. Therefore, an open drain output can be connected directly. It is recommended to pull up FIB pin to VREG voltage when this function is not used or malfunctioning because of the noise.

14) Hall signal wrong input detection

Hall element abnormalities may cause incorrect inputs that vary from the normal logic. When all hall input signals go high or low, the hall signal wrong input detection circuit forces all driver outputs low. And when the controller detects the abnormal hall signals continuously for four times or more motor rotation, the controller forces all driver outputs low and latches the state. It is released if the duty control voltage VSP is forced to ground level once.

15) Internal voltage regulator

The internal voltage regulator VREG is output for the bias of the hall element and the phase control setting. However, when using the VREG function, be aware of the I_{OMAX} value. If a capacitor is connected to the ground in order to stabilize output, a value of 1 μF or more should be used. In this case, be sure to confirm that there is no oscillation in the output.

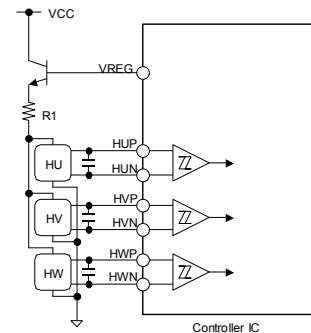

Figure 6. VREG output pin application example

● Timing Charts (CW)

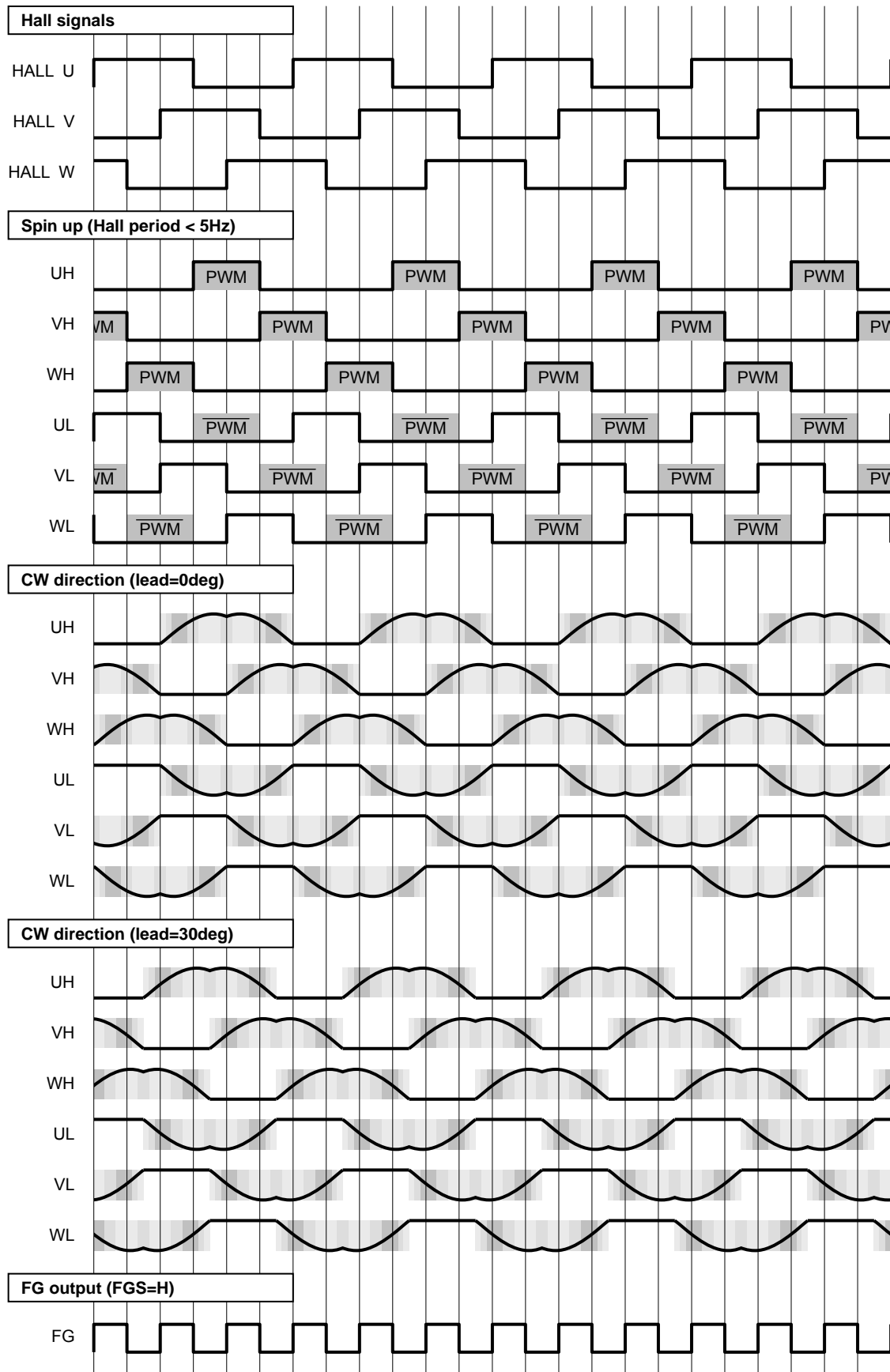

Figure 7. BD62011AFS (Clockwise) timing charts

● Timing Charts (CCW)

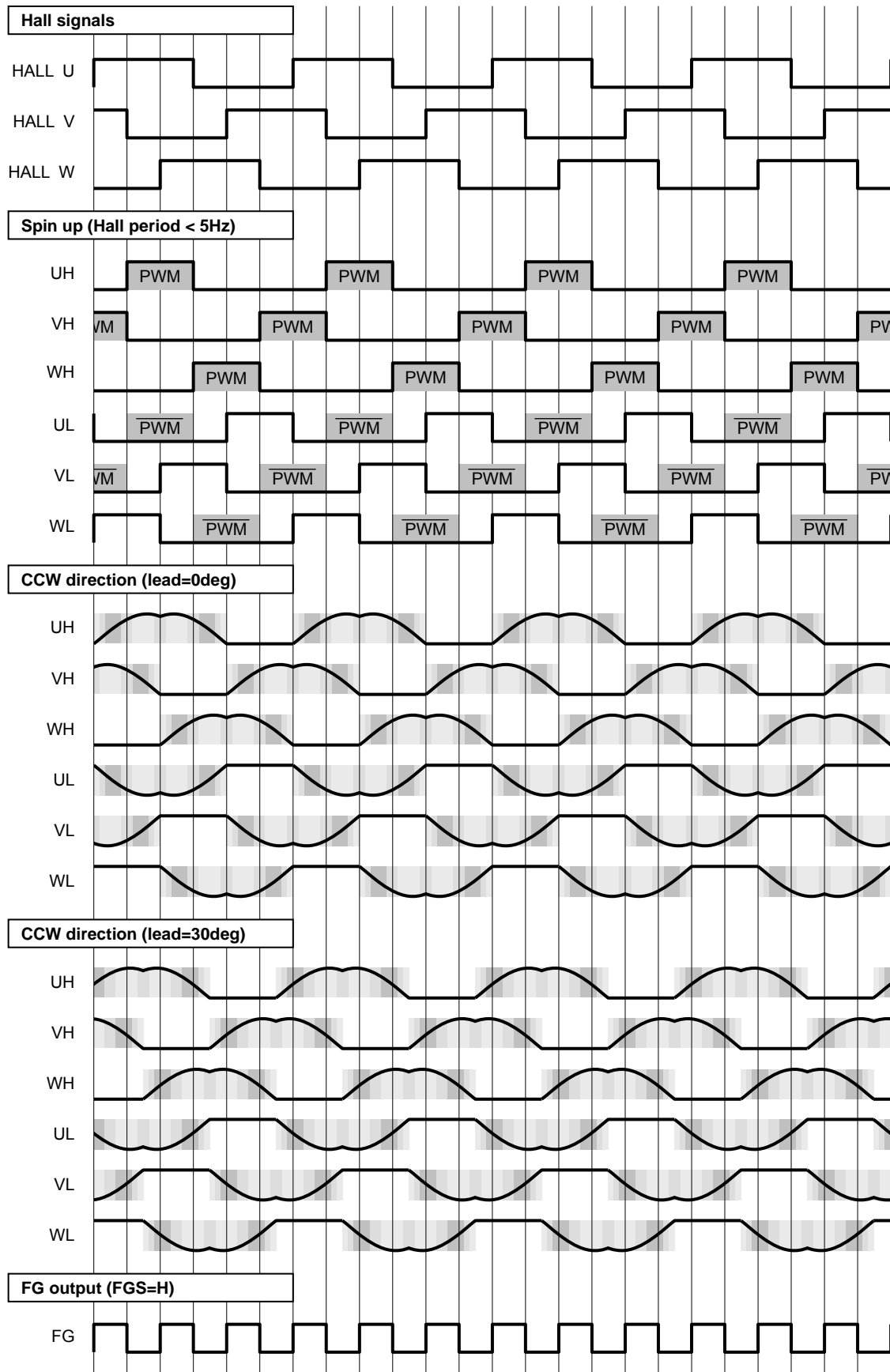

Figure 8. BD62011AFS (Counter clockwise) timing charts

● Controller Outputs and Operation Mode Summary

Conditions	Detected direction	Forward (CW:U~V~W, CCW:U~W~V)		Reverse (CW:U~W~V, CCW:U~V~W)	
	Hall sensor period	< 5Hz	5Hz <	< 5Hz	5Hz <
Normal operation	$V_{SP} < V_{SPMIN}$ (Duty off)	Upper and lower arm off			
	$V_{SPMIN} < V_{SP} < V_{SPMAX}$ (Control range)	120° Upper and lower switching	180° sinusoidal Upper and lower switching	120° Upper and lower switching	120° Upper switching
	$V_{SPTST} < V_{SP}$ (Testing mode)		180° sinusoidal Upper and lower switching (No lead angle)		
Protect operation	Overcurrent	Upper arm off		Upper and lower arm off	
	UVLO	Upper and lower arm off			
	TSD				
	Motor lock				
	External input				
	Hall sensor abnormally	Upper and lower arm off and latch			

* The controller monitors both edges of three hall sensors for detecting period.

* Phase control function only operates at sinusoidal commutation mode. However, the controller forces no lead angle during the testing mode.

● Absolute Maximum Ratings (Ta=25°C, All voltages are with respect to ground)

Parameter	Symbol	Ratings	Unit
		BD62011AFS	
Supply voltage	V_{CC}	20 ^{*1}	V
Duty control voltage	V_{SP}	-0.3 to 20	V
All others	V_{IO}	-0.3 to 5.5	V
Driver outputs	$I_{OMAX(OUT)}$	±15 ^{*1}	mA
Monitor output	$I_{OMAX(FG)}$	±5 ^{*1}	mA
VREG outputs	$I_{OMAX(VREG)}$	-40 ^{*1}	mA
Operating temperature	T_{OPR}	-40 to 110	°C
Storage temperature	T_{STG}	-55 to 150	°C
Power dissipation	P_d	1.00 ^{*2}	W
Junction temperature	T_{jmax}	150	°C

*1 Do not, however, exceed P_d or ASO.

*2 Mounted on a 70mm x 70mm x 1.6mm FR4 glass-epoxy board with less than 3% copper foil. Derated at 8mW/°C above 25°C.

● Operating Conditions (Ta=25°C)

Parameter	Symbol	BD62011AFS	Unit
Supply voltage	V_{CC}	10 to 18	V

● **Electrical Characteristics** (Unless otherwise specified, Ta=25°C and VCC=15V)

Parameter	Symbol	Limits			Unit	Conditions
		Min.	Typ.	Max.		
Power supply						
Supply current	I _{CC}	2.0	2.8	5.0	mA	
VREG voltage	V _{REG}	4.5	5.0	5.5	V	I _O =-30mA
Driver outputs						
Output high voltage	V _{OH}	V _{REG} -0.60	V _{REG} -0.20	V _{REG}	V	I _O =-5mA
Output low voltage	V _{OL}	0	0.14	0.60	V	I _O =5mA
Dead time	T _{DT}	1.6	2.0	2.4	μs	
Minimum pulse width	T _{MIN}	0.8	1.0	1.2	μs	
Hall comparators						
Input bias current	I _{HALL}	-2.0	-0.1	2.0	μA	V _{IN} =0 V
Common mode input	V _{HALLCM}	0	-	V _{REG} -1.5	V	
Minimum input level	V _{HALLMIN}	50	-	-	mV _{p-p}	
Hysteresis voltage P	V _{HALLHY+}	5	13	23	mV	
Hysteresis voltage N	V _{HALLHY-}	-23	-13	-5	mV	
Duty control						
Input bias current	I _{SP}	15	25	35	μA	V _{IN} =5V
Duty minimum voltage	V _{SPMIN}	1.8	2.1	2.4	V	
Duty maximum voltage	V _{SPMAX}	5.1	5.4	5.7	V	
Testing mode range	V _{SPTST}	8.2	-	18	V	
Minimum output duty	D _{MIN}	1.2	1.8	2.4	%	F _{OSC} =18kHz
Maximum output duty	D _{MAX}	-	100	-	%	F _{OSC} =18kHz
Mode switch and the external input - FGS, CCW and FIB						
Input bias current	I _{IN}	-70	-50	-30	μA	V _{IN} =0V
Input high voltage	V _{INH}	3	-	V _{REG}	V	
Input low voltage	V _{INL}	0	-	1	V	
Hysteresis voltage	V _{INHY}	0.2	0.5	0.8	V	
Monitor output - FG						
Output high voltage	V _{MONH}	V _{REG} -0.40	V _{REG} -0.08	V _{REG}	V	I _O =-2mA
Output low voltage	V _{MONL}	0	0.06	0.40	V	I _O =2mA
Overcurrent protection						
Input bias current	I _{RCL}	-30	-20	-10	μA	V _{IN} =0V
Threshold voltage	V _{RCL}	0.48	0.50	0.52	V	
Noise masking time	T _{RCL}	0.8	1.0	1.2	μs	
Phase control						
Minimum lead angle	P _{MIN}	-	0	1	deg	V _{PC} =0V
Maximum lead angle	P _{MAX}	39	40	-	deg	V _{PC} =2/3·V _{REG}
Carrier frequency oscillator						
Carrier frequency	F _{OSC}	16	18	20	kHz	R _T =22kΩ
Under voltage lock out						
Release voltage	V _{UVH}	8.5	9.0	9.5	V	
Lockout voltage	V _{UVL}	7.5	8.0	8.5	V	
Hysteresis voltage	V _{UVHY}	0.5	1.0	1.5	V	

● Typical Performance Curves (Reference data)

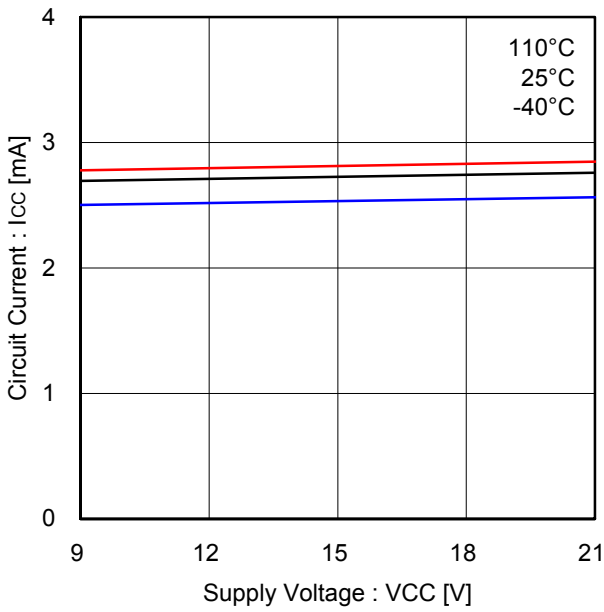

Figure 9. Circuit current

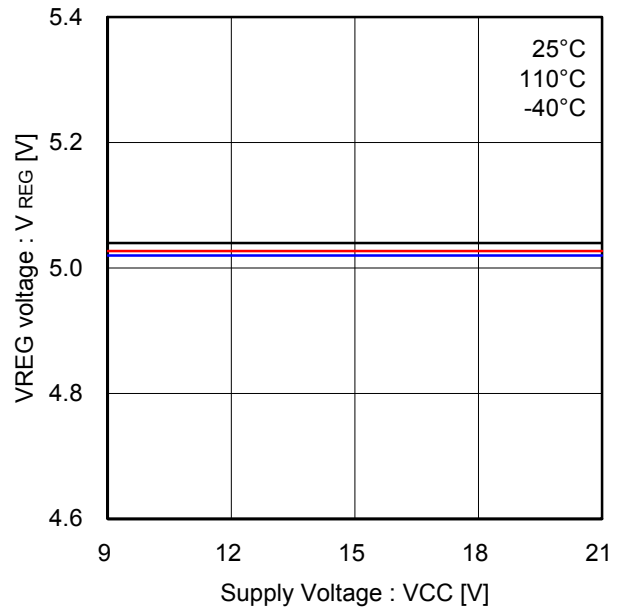

Figure 10. VREG - VCC

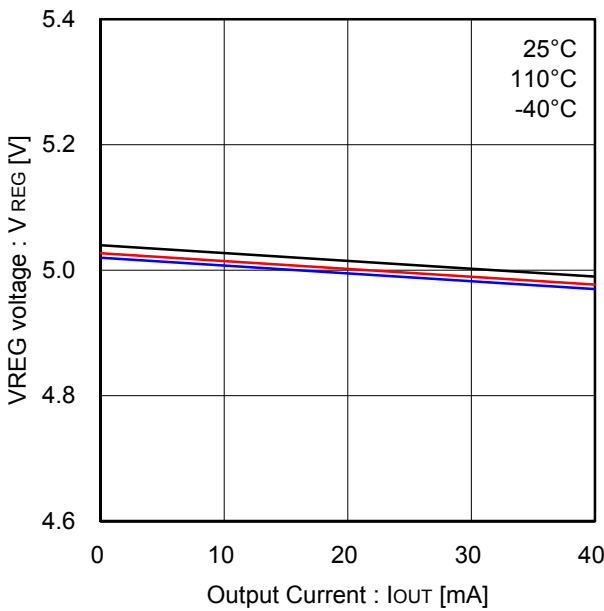

Figure 11. VREG drive capability

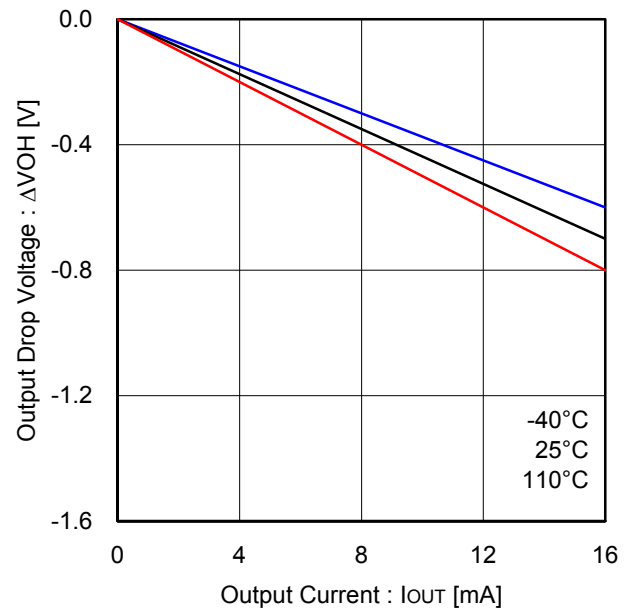

Figure 12. High side output voltage (XH, XL)

● Typical Performance Curves (Reference data) - Continued

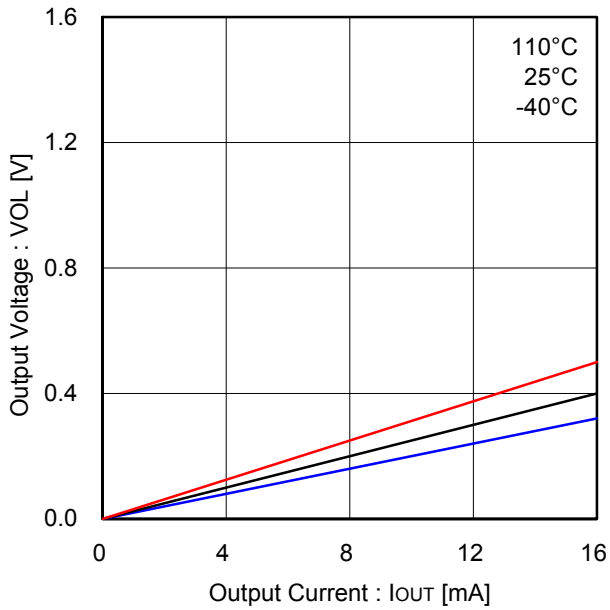

Figure 13. Low side output voltage (XH, XL)

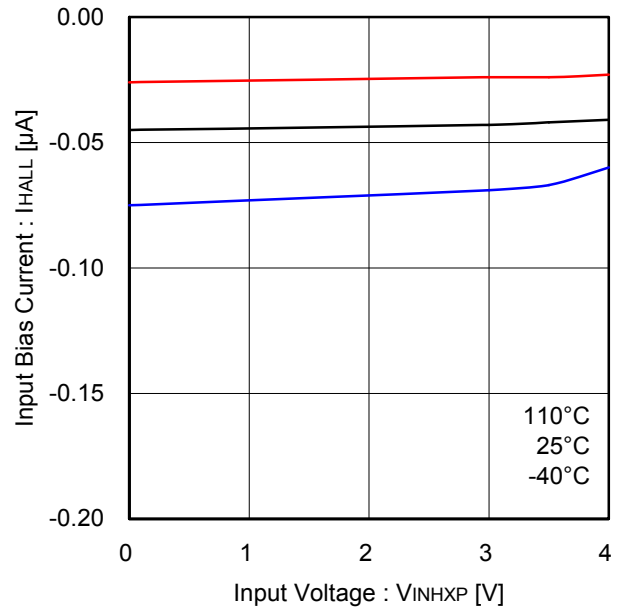

Figure 14. Hall comparator input bias current (HXP, HXN)

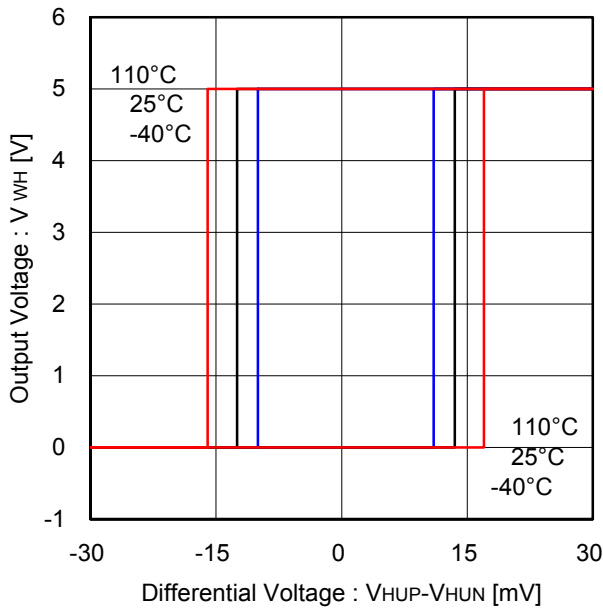

Figure 15. Hall comparator hysteresis voltage

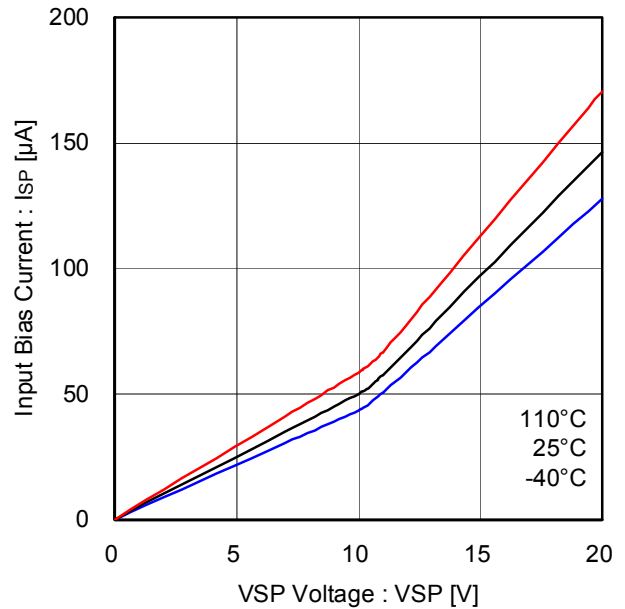

Figure 16. VSP input bias current

● Typical Performance Curves (Reference data) - Continued

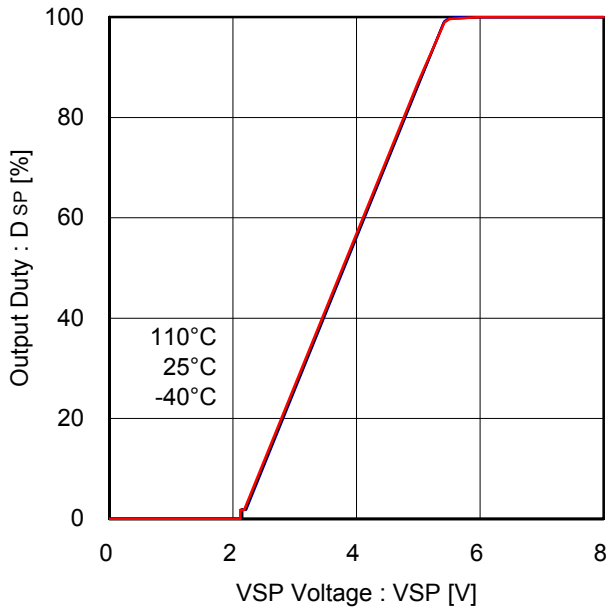

Figure 17. Output duty - VSP voltage

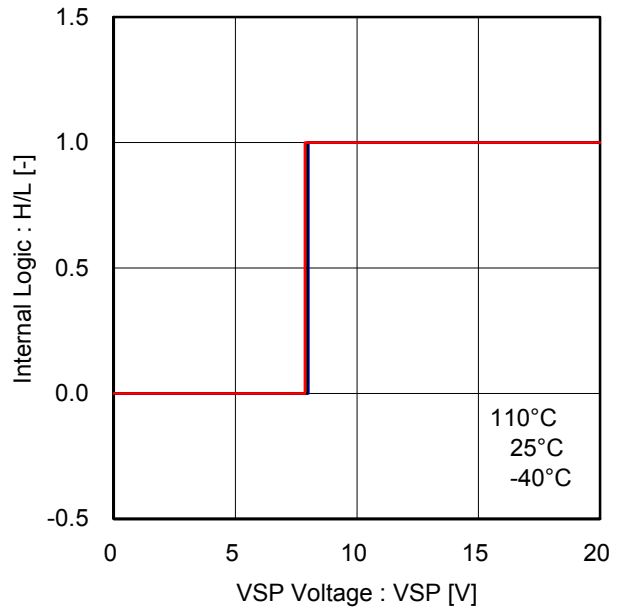

Figure 18. Testing mode threshold voltage

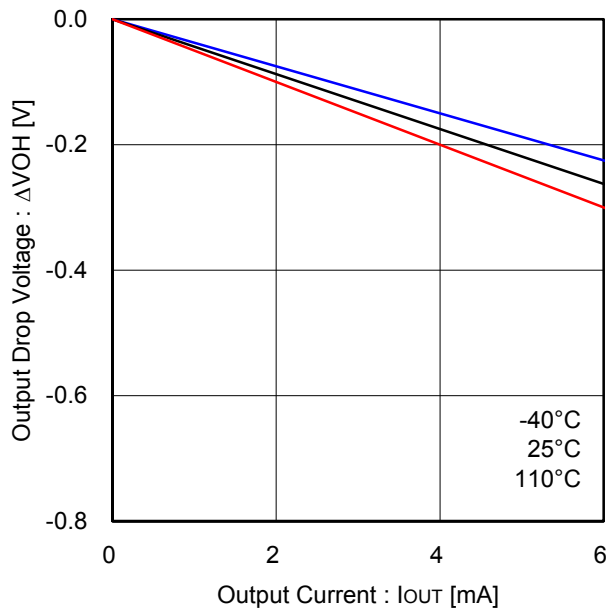

Figure 19. High side output voltage (FG)

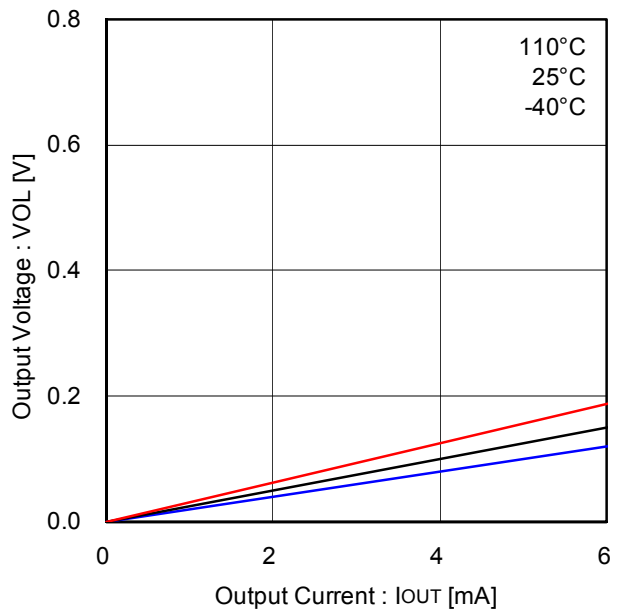

Figure 20. Low side output voltage (FG)

● Typical Performance Curves (Reference data) - Continued

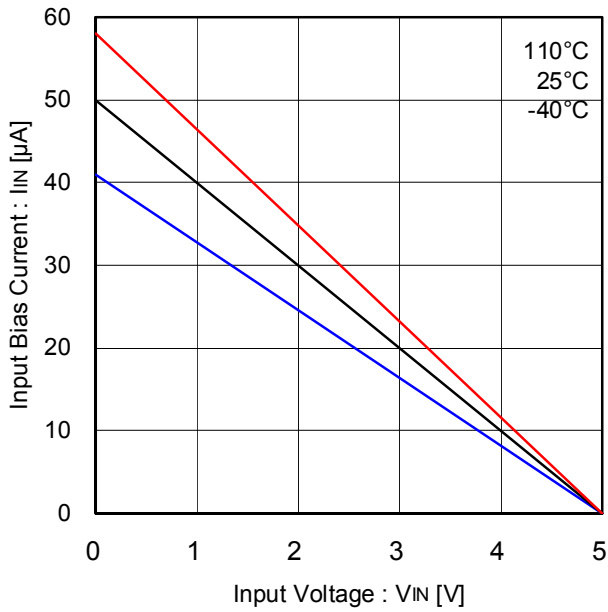

Figure 21. Input bias current (CCW, FIB)

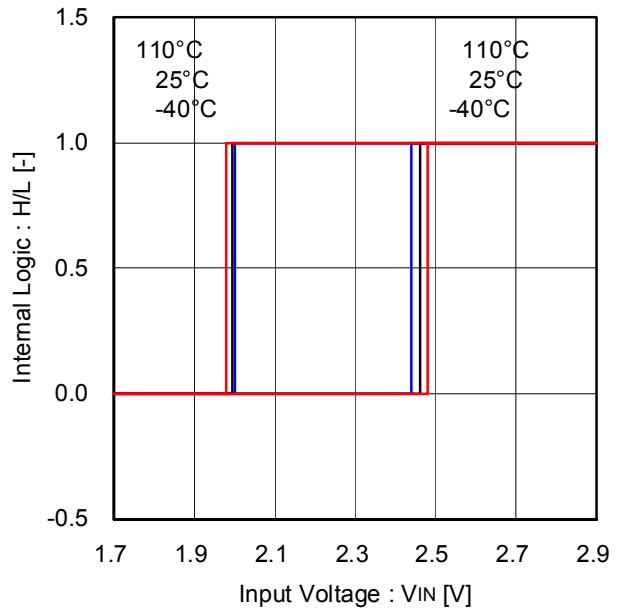

Figure 22. Input threshold voltage (CCW, FIB)

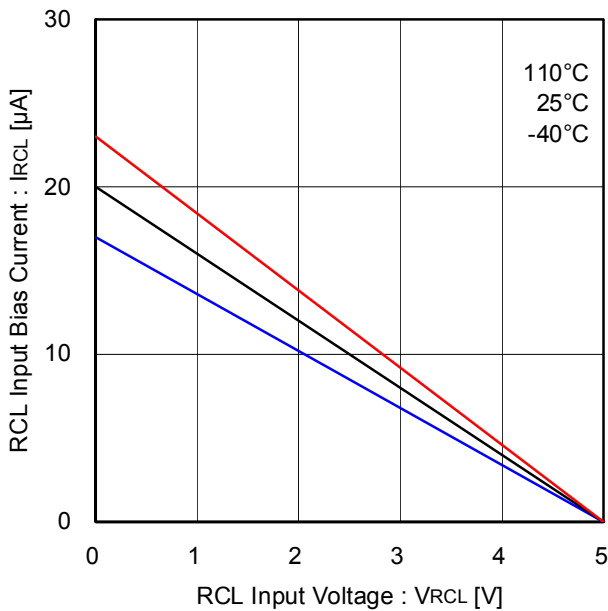

Figure 23. RCL input bias current

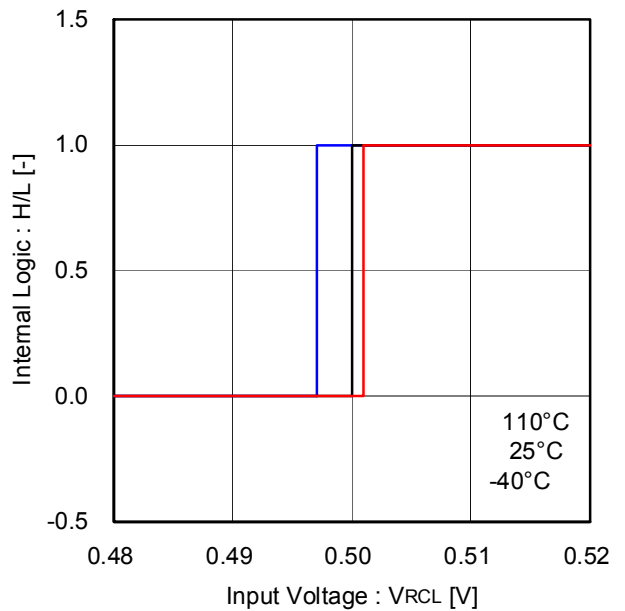

Figure 24. RCL input threshold voltage

● Typical Performance Curves (Reference data) - Continued

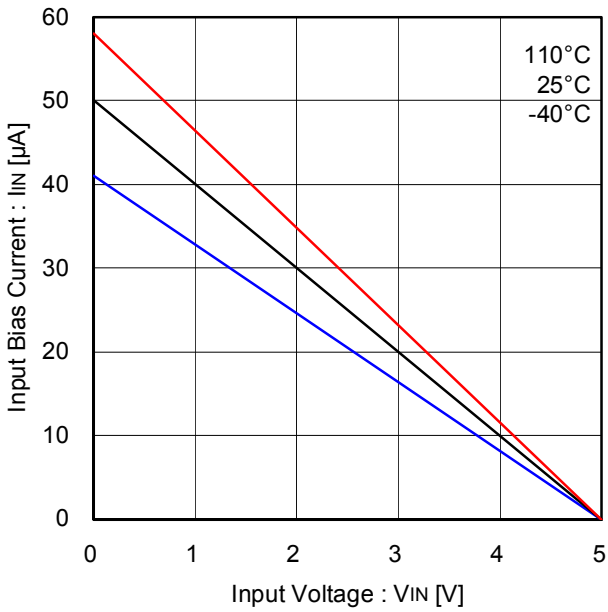

Figure 25. Input bias current (FGS)

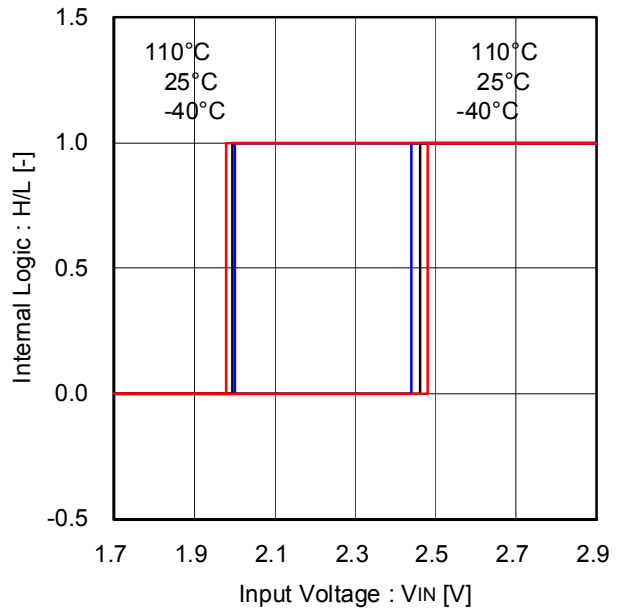

Figure 26. Input threshold voltage (FGS)

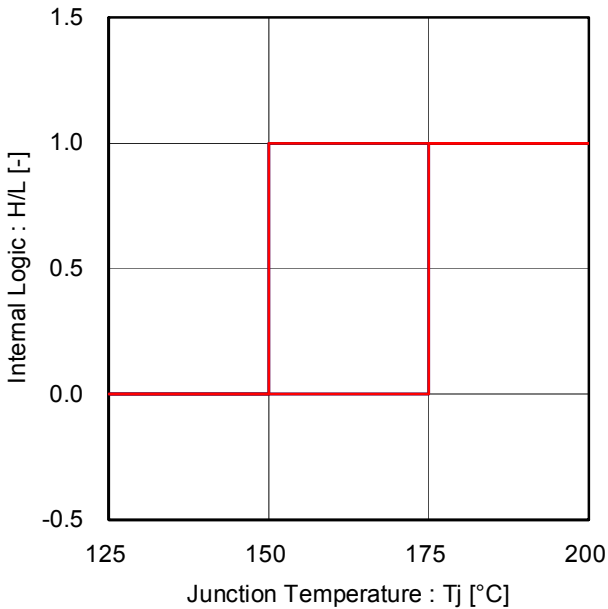

Figure 27. Thermal shut down

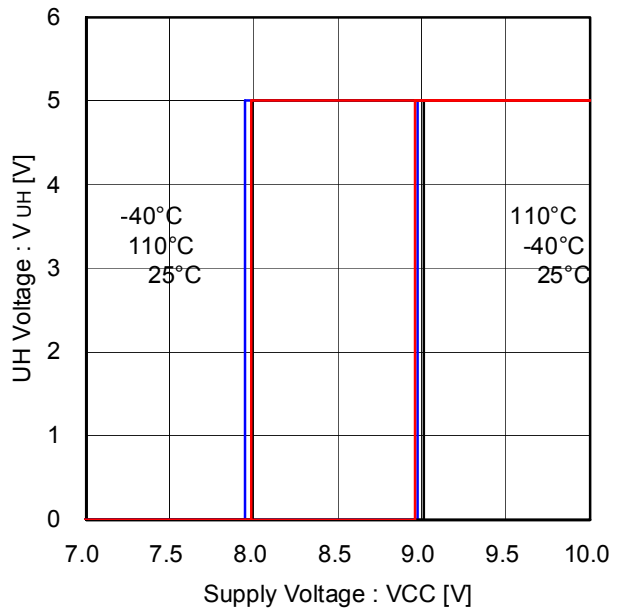

Figure 28. Under voltage lock out (VCC)

● Typical Performance Curves (Reference data) - Continued

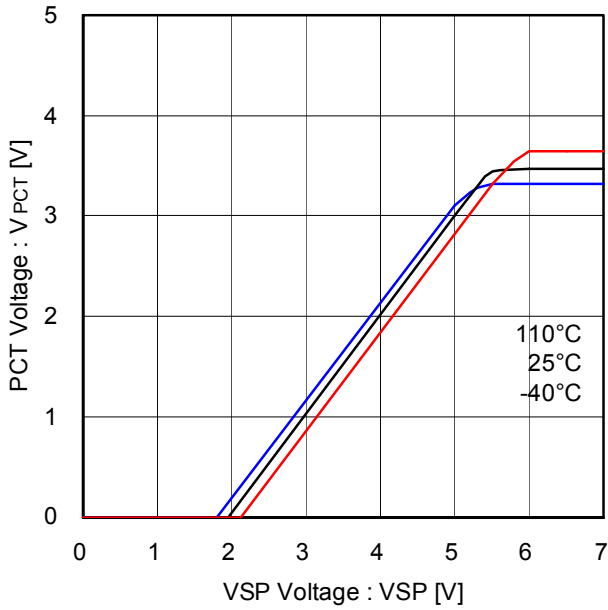

Figure 29. VSP - PCT offset voltage

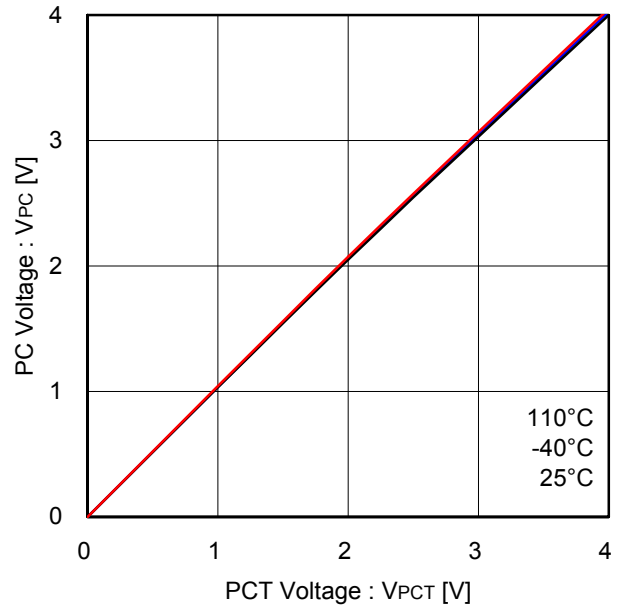

Figure 30. PCT - PC linearity
($R_{PCT}=R_{PC}=100k\Omega$)

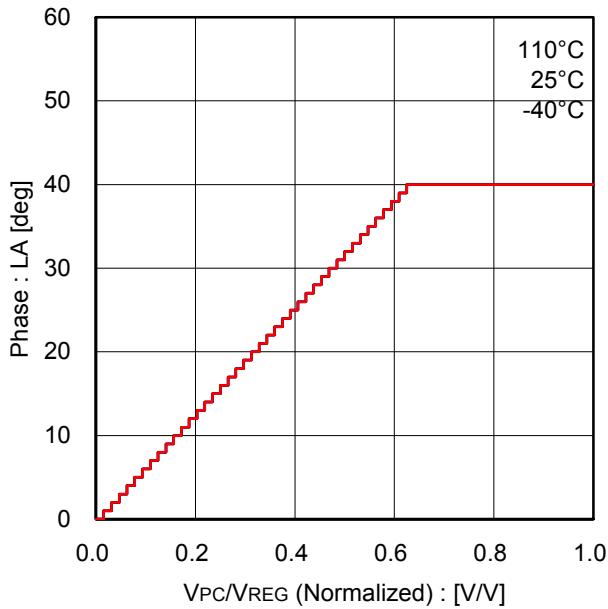

Figure 31. PC voltage normalized - Lead angle

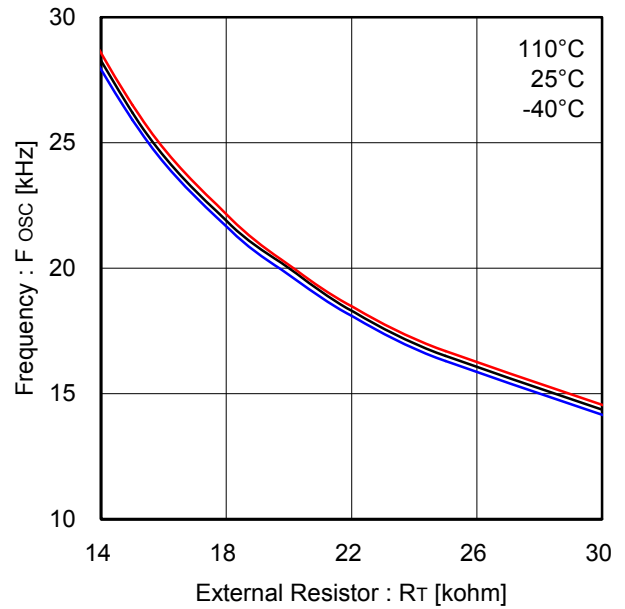

Figure 32. Carrier frequency - RT

● Application Circuit Example

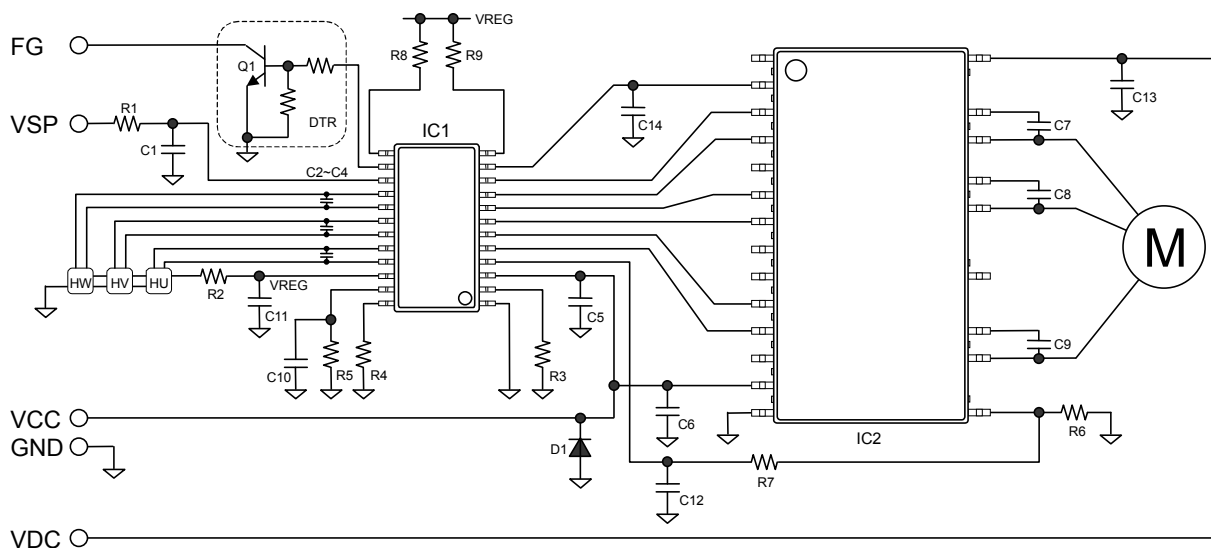

Figure 33. Application circuit example (180° sinusoidal commutation driver)

Parts list

Parts	Value	Manufacturer	Type	Parts	Value	Rated	Type
IC1	-	ROHM	BD62011AFS	C1	0.1μF	50V	Ceramic
IC2	-	ROHM	BM6202FS	C2-4	2200pF	50V	Ceramic
R1	1kΩ	ROHM	MCR18EZPF1001	C5	10 μF	50V	Ceramic
R2	150Ω	ROHM	MCR18EZPJ151	C6	10 μF	50V	Ceramic
R3	22kΩ	ROHM	MCR18EZPF2202	C7-9	1μF	50V	Ceramic
R4	100kΩ	ROHM	MCR18EZPF1003	C10	0.1μF	50V	Ceramic
R5	51kΩ	ROHM	MCR18EZPF5102	C11	1μF	50V	Ceramic
R6	0.5Ω	ROHM	MCR50JZHFL1R50 x 3	C12	100pF	50V	Ceramic
R7	10kΩ	ROHM	MCR18EZPF1002	C13	0.1μF	630V	Ceramic
R8	0Ω	ROHM	MCR18EZPJ000	C14	0.1μF	50V	Ceramic
R9	0Ω	ROHM	MCR18EZPJ000	HX	-	-	Hall elements
Q1	-	ROHM	DTC124EUA				
D1	-	ROHM	KDZ20B				

● Interfaces

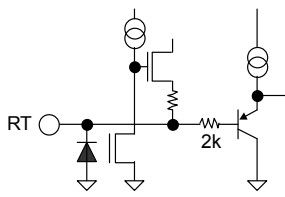

Figure 34. RT

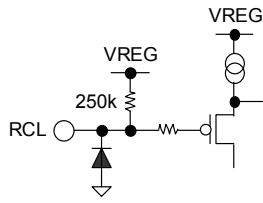

Figure 35. RCL

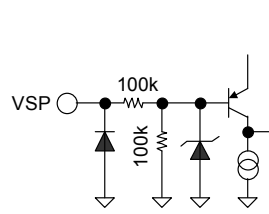

Figure 36. VSP

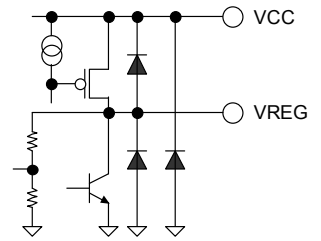

Figure 37. VREG, VCC

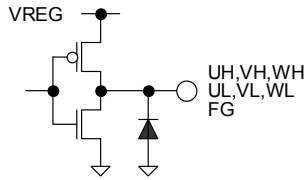

Figure 38. XH, XL, FG

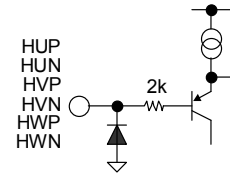

Figure 39. HXP, HXN

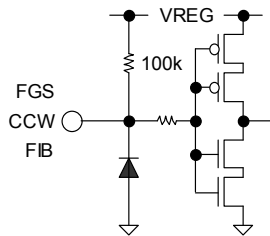

Figure 40. FGS, CCW, FIB

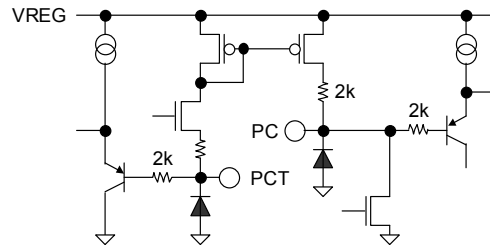

Figure 41. PC, PCT

● Notes for Use

1) Absolute maximum ratings

Devices may be destroyed when supply voltage or operating temperature exceeds the absolute maximum rating. Because the cause of this damage cannot be identified as, for example, a short circuit or an open circuit, it is important to consider circuit protection measures, such as adding fuses, if any value in excess of absolute maximum ratings is to be implemented.

2) Electrical potential at GND

Keep the GND terminal to the minimum potential under any operating condition. In addition, check to determine whether there is any terminal that provides voltage below GND, including the voltage during transient phenomena. However, note that even if the voltage does not fall below GND in any other operating condition, it can still swing below GND potential when the motor generates back electromotive force at the RCL terminal. The chip layout in this product is designed to avoid this sort of electrical potential problem, but pulling excessive current may still result in malfunctions. Therefore, it is necessary to observe operation closely to conclusively confirm that there is no problem in actual operation. If there are small signal GND and high current GND, it is recommended to separate the patterns for the high current GND and the small signal GND and provide a proper grounding to the reference point of the set not to affect the voltage at the small signal GND with the change in voltage due to resistance component of pattern wiring and high current. Also for GND wiring pattern of the component externally connected, pay special attention not to cause undesirable change to it.

3) Driver outputs

The high voltage semiconductor generally driven by this product is connected to the next stage via the controller. If any special mode in excess of absolute maximum ratings is to be implemented with this product or its application circuits, it is important to take physical safety measures, such as providing voltage-clamping diodes or fuses.

4) Thermal design

Use a thermal design that allows sufficient margin in light of the power dissipation (Pd) in actual operating conditions.

5) Inter-pin shorts and mounting errors

Take caution when positioning the IC for mounting on printed circuit boards. The IC may be damaged if there is any connection error or if pins are shorted together. Also, connecting the power supply in reverse polarity can damage the IC. Take precautions against reverse polarity when connecting the power supply lines, such as establishing an external diode between the power supply and the IC power supply pin.

6) Operation in strong electromagnetic fields

Using this product in strong electromagnetic fields may cause IC malfunctions. Take extreme caution with electromagnetic fields.

7) Testing on application boards

When testing the IC on an application board, connecting a capacitor to a low impedance pin subjects the IC to stress. Always discharge capacitors after each process or step. Always turn the IC's power supply off before connecting it to or removing it from a jig or fixture during the inspection process. Ground the IC during assembly steps as an antistatic measure. Use similar precaution when transporting or storing the IC.

8) Regarding the input pin of the IC

This monolithic IC contains P+ isolation and P substrate layers between adjacent elements, in order to keep them isolated. P-N junctions are formed at the intersection of these P layers with the N layers of other elements, creating a parasitic diode or transistor. For example, the relation between each potential is as follows:

When $GND > Pin A$ and $GND > Pin B$, the P-N junction operates as a parasitic diode.

When $GND > Pin B$, the P-N junction operates as a parasitic transistor.

Parasitic diodes inevitably occur in the structure of the IC. The operation of parasitic diodes can result in mutual interference among circuits, as well as operating malfunctions and physical damage. Therefore, do not use methods by which parasitic diodes operate, such as applying a voltage lower than the GND (P substrate) voltage to an input pin.

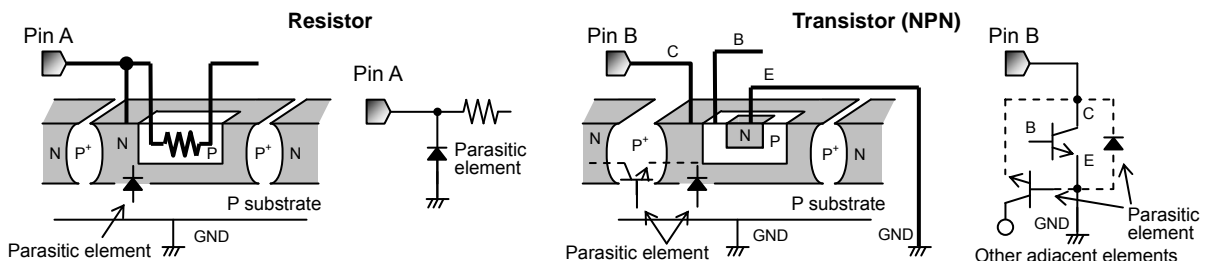

Appendix: Example of monolithic IC structure

● Ordering Information

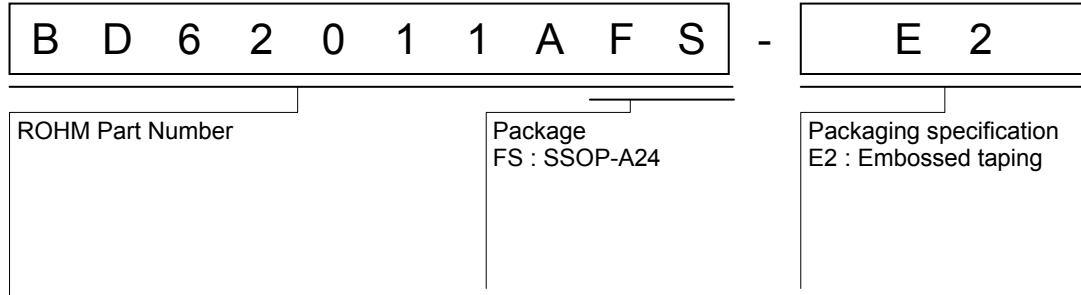

● Physical Dimension, Tape and Reel Information

SSOP-A24

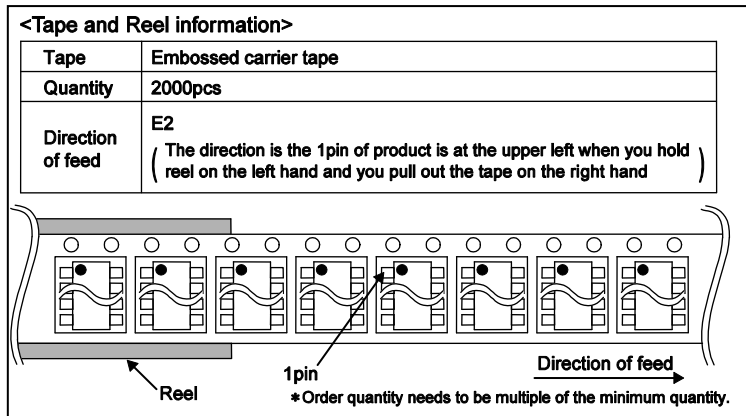
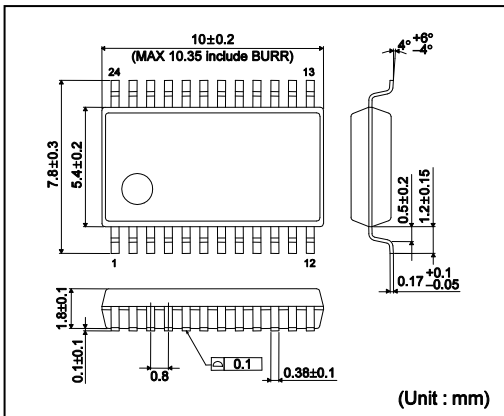

● Marking Diagram

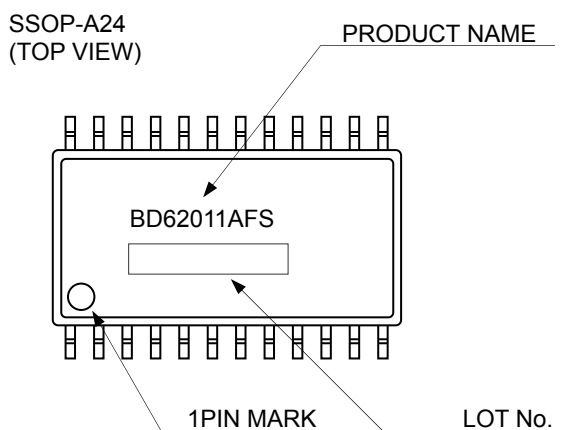

● Revision History

Date	Revision	Changes
18.DEC.2015	001	New release
03.JUN.2016	002	Correct some misdescriptions

Notice

Precaution on using ROHM Products

- Our Products are designed and manufactured for application in ordinary electronic equipments (such as AV equipment, OA equipment, telecommunication equipment, home electronic appliances, amusement equipment, etc.). If you intend to use our Products in devices requiring extremely high reliability (such as medical equipment ^(Note 1), transport equipment, traffic equipment, aircraft/spacecraft, nuclear power controllers, fuel controllers, car equipment including car accessories, safety devices, etc.) and whose malfunction or failure may cause loss of human life, bodily injury or serious damage to property ("Specific Applications"), please consult with the ROHM sales representative in advance. Unless otherwise agreed in writing by ROHM in advance, ROHM shall not be in any way responsible or liable for any damages, expenses or losses incurred by you or third parties arising from the use of any ROHM's Products for Specific Applications.

(Note1) Medical Equipment Classification of the Specific Applications

JAPAN	USA	EU	CHINA
CLASS III	CLASS III	CLASS II b	CLASS III
CLASS IV		CLASS III	

- ROHM designs and manufactures its Products subject to strict quality control system. However, semiconductor products can fail or malfunction at a certain rate. Please be sure to implement, at your own responsibilities, adequate safety measures including but not limited to fail-safe design against the physical injury, damage to any property, which a failure or malfunction of our Products may cause. The following are examples of safety measures:
 - Installation of protection circuits or other protective devices to improve system safety
 - Installation of redundant circuits to reduce the impact of single or multiple circuit failure
- Our Products are designed and manufactured for use under standard conditions and not under any special or extraordinary environments or conditions, as exemplified below. Accordingly, ROHM shall not be in any way responsible or liable for any damages, expenses or losses arising from the use of any ROHM's Products under any special or extraordinary environments or conditions. If you intend to use our Products under any special or extraordinary environments or conditions (as exemplified below), your independent verification and confirmation of product performance, reliability, etc. prior to use, must be necessary:
 - Use of our Products in any types of liquid, including water, oils, chemicals, and organic solvents
 - Use of our Products outdoors or in places where the Products are exposed to direct sunlight or dust
 - Use of our Products in places where the Products are exposed to sea wind or corrosive gases, including Cl₂, H₂S, NH₃, SO₂, and NO₂
 - Use of our Products in places where the Products are exposed to static electricity or electromagnetic waves
 - Use of our Products in proximity to heat-producing components, plastic cords, or other flammable items
 - Sealing or coating our Products with resin or other coating materials
 - Use of our Products without cleaning residue of flux (even if you use no-clean type fluxes, cleaning residue of flux is recommended); or Washing our Products by using water or water-soluble cleaning agents for cleaning residue after soldering
 - Use of the Products in places subject to dew condensation
- The Products are not subject to radiation-proof design.
- Please verify and confirm characteristics of the final or mounted products in using the Products.
- In particular, if a transient load (a large amount of load applied in a short period of time, such as pulse. is applied, confirmation of performance characteristics after on-board mounting is strongly recommended. Avoid applying power exceeding normal rated power; exceeding the power rating under steady-state loading condition may negatively affect product performance and reliability.
- De-rate Power Dissipation depending on ambient temperature. When used in sealed area, confirm that it is the use in the range that does not exceed the maximum junction temperature.
- Confirm that operation temperature is within the specified range described in the product specification.
- ROHM shall not be in any way responsible or liable for failure induced under deviant condition from what is defined in this document.

Precaution for Mounting / Circuit board design

- When a highly active halogenous (chlorine, bromine, etc.) flux is used, the residue of flux may negatively affect product performance and reliability.
- In principle, the reflow soldering method must be used on a surface-mount products, the flow soldering method must be used on a through hole mount products. If the flow soldering method is preferred on a surface-mount products, please consult with the ROHM representative in advance.

For details, please refer to ROHM Mounting specification

Precautions Regarding Application Examples and External Circuits

1. If change is made to the constant of an external circuit, please allow a sufficient margin considering variations of the characteristics of the Products and external components, including transient characteristics, as well as static characteristics.
2. You agree that application notes, reference designs, and associated data and information contained in this document are presented only as guidance for Products use. Therefore, in case you use such information, you are solely responsible for it and you must exercise your own independent verification and judgment in the use of such information contained in this document. ROHM shall not be in any way responsible or liable for any damages, expenses or losses incurred by you or third parties arising from the use of such information.

Precaution for Electrostatic

This Product is electrostatic sensitive product, which may be damaged due to electrostatic discharge. Please take proper caution in your manufacturing process and storage so that voltage exceeding the Products maximum rating will not be applied to Products. Please take special care under dry condition (e.g. Grounding of human body / equipment / solder iron, isolation from charged objects, setting of Ionizer, friction prevention and temperature / humidity control).

Precaution for Storage / Transportation

1. Product performance and soldered connections may deteriorate if the Products are stored in the places where:
 - [a] the Products are exposed to sea winds or corrosive gases, including Cl₂, H₂S, NH₃, SO₂, and NO₂
 - [b] the temperature or humidity exceeds those recommended by ROHM
 - [c] the Products are exposed to direct sunshine or condensation
 - [d] the Products are exposed to high Electrostatic
2. Even under ROHM recommended storage condition, solderability of products out of recommended storage time period may be degraded. It is strongly recommended to confirm solderability before using Products of which storage time is exceeding the recommended storage time period.
3. Store / transport cartons in the correct direction, which is indicated on a carton with a symbol. Otherwise bent leads may occur due to excessive stress applied when dropping of a carton.
4. Use Products within the specified time after opening a humidity barrier bag. Baking is required before using Products of which storage time is exceeding the recommended storage time period.

Precaution for Product Label

A two-dimensional barcode printed on ROHM Products label is for ROHM's internal use only.

Precaution for Disposition

When disposing Products please dispose them properly using an authorized industry waste company.

Precaution for Foreign Exchange and Foreign Trade act

Since concerned goods might be fallen under listed items of export control prescribed by Foreign exchange and Foreign trade act, please consult with ROHM in case of export.

Precaution Regarding Intellectual Property Rights

1. All information and data including but not limited to application example contained in this document is for reference only. ROHM does not warrant that foregoing information or data will not infringe any intellectual property rights or any other rights of any third party regarding such information or data.
2. ROHM shall not have any obligations where the claims, actions or demands arising from the combination of the Products with other articles such as components, circuits, systems or external equipment (including software).
3. No license, expressly or implied, is granted hereby under any intellectual property rights or other rights of ROHM or any third parties with respect to the Products or the information contained in this document. Provided, however, that ROHM will not assert its intellectual property rights or other rights against you or your customers to the extent necessary to manufacture or sell products containing the Products, subject to the terms and conditions herein.

Other Precaution

1. This document may not be reprinted or reproduced, in whole or in part, without prior written consent of ROHM.
2. The Products may not be disassembled, converted, modified, reproduced or otherwise changed without prior written consent of ROHM.
3. In no event shall you use in any way whatsoever the Products and the related technical information contained in the Products or this document for any military purposes, including but not limited to, the development of mass-destruction weapons.
4. The proper names of companies or products described in this document are trademarks or registered trademarks of ROHM, its affiliated companies or third parties.

General Precaution

1. Before you use our Products, you are requested to carefully read this document and fully understand its contents. ROHM shall not be in any way responsible or liable for failure, malfunction or accident arising from the use of any ROHM's Products against warning, caution or note contained in this document.
2. All information contained in this document is current as of the issuing date and subject to change without any prior notice. Before purchasing or using ROHM's Products, please confirm the latest information with a ROHM sales representative.
3. The information contained in this document is provided on an "as is" basis and ROHM does not warrant that all information contained in this document is accurate and/or error-free. ROHM shall not be in any way responsible or liable for any damages, expenses or losses incurred by you or third parties resulting from inaccuracy or errors of or concerning such information.



BD62011AFS - Web Page

[Distribution Inventory](#)

Part Number	BD62011AFS
Package	SSOP-A24
Unit Quantity	2000
Minimum Package Quantity	2000
Packing Type	Taping
Constitution Materials List	inquiry
RoHS	Yes