

1) Powering Up the SP6136EB Circuit

Connect the SP6136ER1 Evaluation Board with an external +12V power supply. Connect with short leads and large diameter wire directly to the “VIN” and “GND” posts. Connect a Load between the “VOUT” and “GND2” posts, again using short leads with large diameter wire to minimize inductance and voltage drops.

2) Measuring Output Load Characteristics

It's best to GND reference scope and digital meters using the Star GND post in the center of the board. VOUT ripple can best be seen touching probe tip to the pad for COUT and scope ground collar touching Star GND post – avoid a ground lead on the probe which will increase noise pickup.

3) Using the Evaluation Board with Different Output Voltages

While the SP6136ER1 Evaluation Board has been tested and delivered with the output set to 3.30V, by simply changing one resistor, R2, the SP6136ER1 can be set to other output voltages. The relationship in the following formula is based on a voltage divider from the output to the feedback pin VFB, which is set to an internal reference voltage of 0.80V.

Standard 1% metal film resistors of surface mount size 0603 are recommended.

$$V_{out} = 0.80V \left(\frac{R1}{R2} + 1 \right) \Rightarrow \\ R2 = R1 / \left[\left(\frac{V_{out}}{0.80V} \right) - 1 \right]$$

Where $R1 = 68.1K\Omega$ and for $V_{out} = 0.80V$ setting, simply remove R2 from the board. Furthermore, one could select the value of

the R1 and R2 combination to meet the exact output voltage setting by restricting R1 resistance range such that $50K\Omega \leq R1 \leq 100K\Omega$ for overall system loop stability.

Note that since the SP6136ER1 Evaluation Board design was optimized for 12V down conversion to 3.30V, changes of output voltage and/or input voltage may alter performance from the data given in the Power Supply Data section.

POWER SUPPLY DATA

The SP6136ER1 is designed with an accurate 1.5% reference over line, load and temperature. Figure 1 data shows a typical SP6136ER1 Evaluation Board efficiency plot, with efficiencies to 92% and output currents to 7A. Load Regulation in Figure 2 shows only 0.12% change in output voltage from no load to 7A. Figures 3 and 4 show the fast transient response. Start-up corresponding to different load conditions is shown in Figures 5, 6 and 7, where the input current rises smoothly as the soft-start ramp increases. In Figure 8 the hiccup mode gets activated in response to an output dead short circuit condition and will soft-start until the over-load is removed. Figure 9 and 10 show output voltage ripple less than 11mV over complete load range.

While data on individual power supply boards may vary, the capability of the SP6136ER1 of achieving high accuracy over a range of load conditions shown here is quite impressive and desirable for accurate power supply design.

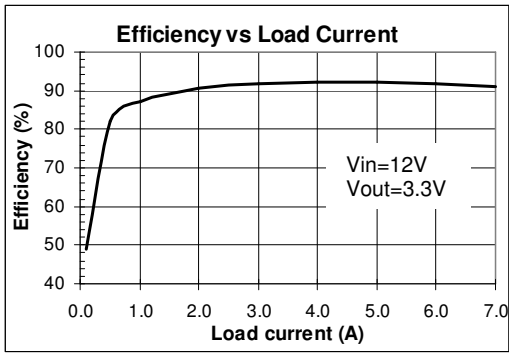

Figure 1. Efficiency vs Load

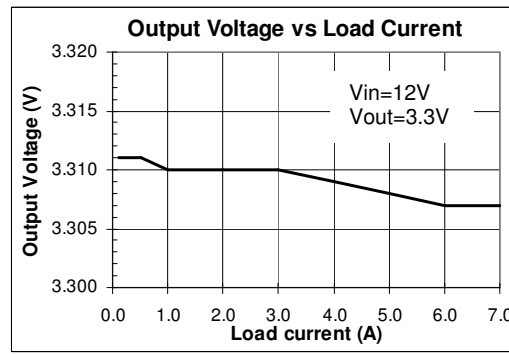

Figure 2. Load Regulation

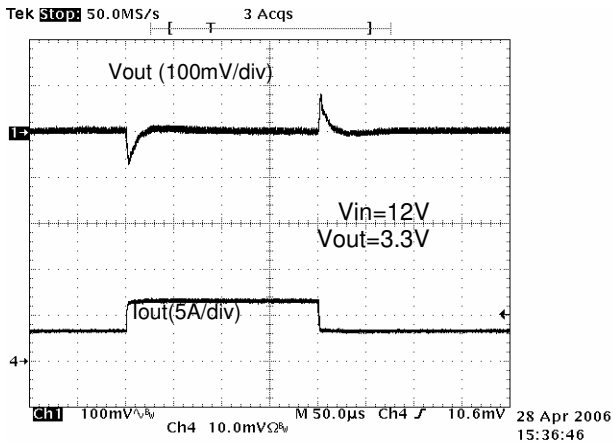

Figure 3. Load Step Response: 3.5A->7A

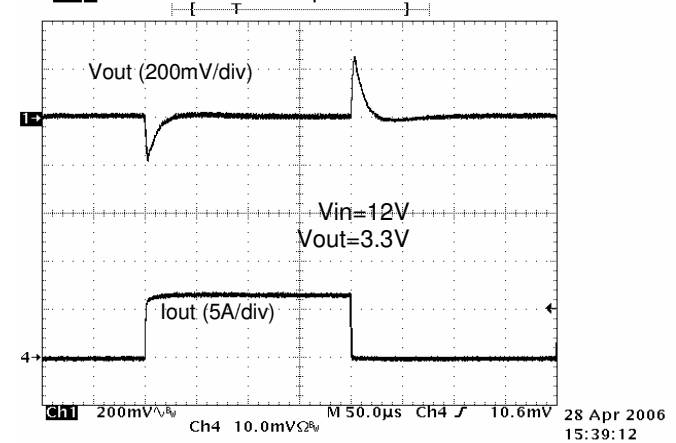

Figure 4. Load Step Response: 0->7A

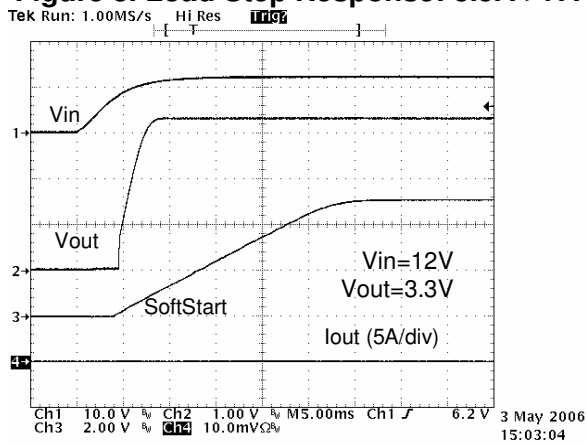

Figure 5. Start-Up Response: No Load

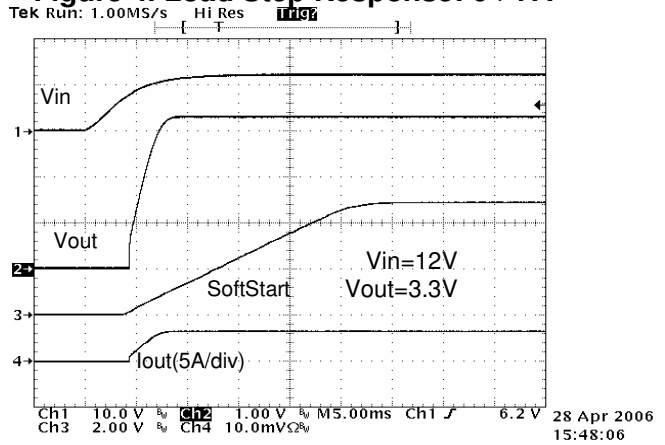

Figure 6. Start-Up Response: 3A Load

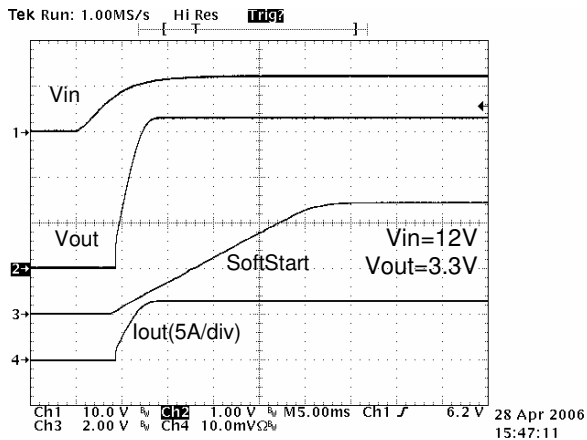

Figure 7. Start-Up Response: 7A Load

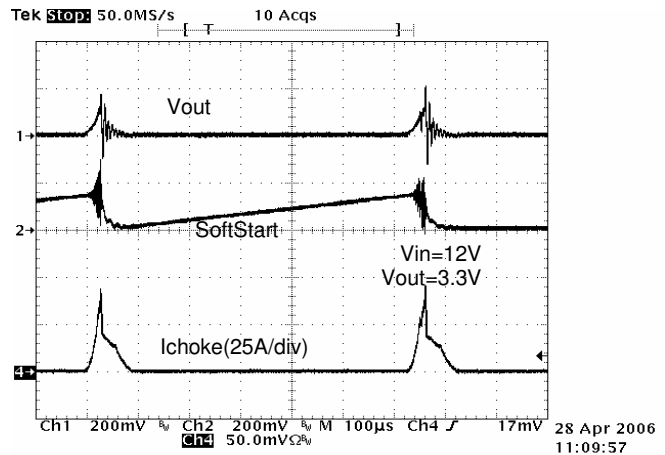

Figure 8. Output Load Short Circuit

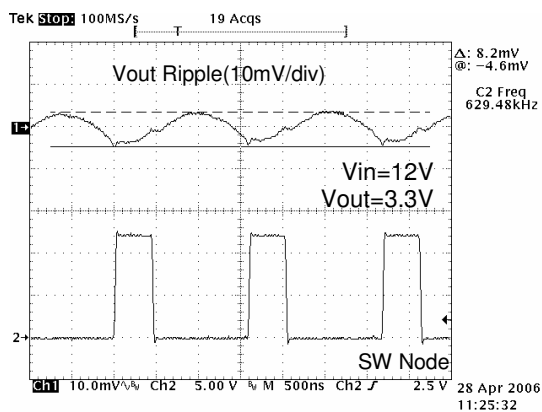

Figure 9. Output Noise at No Load

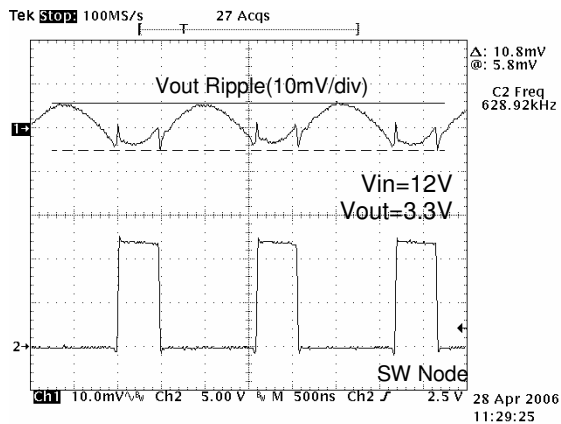

Figure 10. Output Noise at 7A Load

INDUCTORS - SURFACE MOUNT									
Inductance (uH)	Manufacturer/Part No.	Inductor Specification					Inductor Type	Manufacturer Website	
		Series R mOhms	Isat (A)	Size					
				LxW(mm)	Ht.(mm)				
2.2	Inter-Technical SC7232-2R2M	10.4	13.00	7.2x6.6	3.20	Shielded Ferrite Core		www.inter-technical.com	
CAPACITORS - SURFACE MOUNT									
Capacitance (uF)	Manufacturer/Part No.	Capacitor Specification					Capacitor Type	Manufacturer Website	
		ESR ohms (max)	Ripple Current (A) @ 45C	Size		Voltage (V)			
				LxW(mm)	Ht.(mm)				
22	TDK C3225X5R1C226M	0.005	4.00	3X2	2.00	16.0	X5R Ceramic	www.TDK.com	
100	TDK C3225X5R0J107M	0.005	4.00	3X2	2.00	6.3	X5R Ceramic	www.TDK.com	
MOSFETS - SURFACE MOUNT									
MOSFET	Manufacturer/Part No.	MOSFET Specification					Voltage (V)	Foot Print	Manufacturer Website
		RDS(on) ohms (max)	ID Current (A)	Qg					
				nC (Typ)	nC (Max)				
N-Ch	VISHAY Si4354DY	18.50	9.0	7.0	10.5	30.0	SO-8	www.vishay.com	
N-Ch	VISHAY Si4886DY	13.5	11.0	14.5	20.0	30.0	SO-8	www.vishay.com	

Table 1: SP6136EB Suggested Components and Vendor Lists

LOOP COMPENSATION DESIGN

The open loop gain of the SP6136EB can be divided into the gain of the error amplifier **GAMP(s)**, PWM modulator **GPWM**, buck converter output stage **GOUT(s)**, and feedback resistor divider **GFBK**. In order to crossover at the selected frequency **fc**, the gain of the error amplifier has to compensate for the attenuation caused by the rest of the loop at this frequency. The goal of loop compensation is to manipulate the open loop frequency response such that its gain crosses over 0dB at a slope of -20dB/dec . The open loop crossover frequency should be higher than the ESR zero of the output capacitors but less than $1/5$ of the switching frequency **fs** to insure proper operation. Since the SP6136EB is designed with ceramic type output capacitors, a Type III compensation circuit is required to give a phase boost of 180° in order to counteract the effects of the output **LC** under damped resonance double pole frequency.

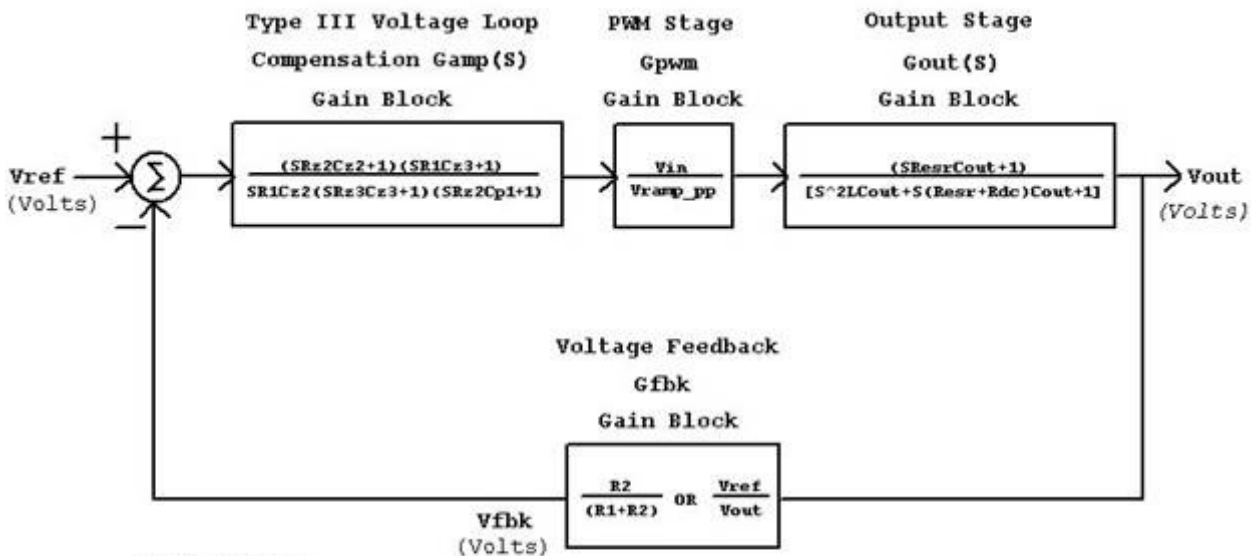

Definitions:

Resr := Output Capacitor Equivalent Series Resistance

Rdc := Output Inductor DC Resistance

Vramp_pp := SP6134 Internal RAMP Amplitude Peak to Peak Voltage

Conditions:

$Cz2 \gg Cp1$ and $R1 \gg Rz3$

Output Load Resistance \gg Resr and Rdc

Figure 11. SP6136EB Voltage Mode Control Loop with Loop Dynamic

The simple guidelines for positioning the poles and zeros and for calculating the component values for Type III compensation are as follows:

$$R1 = 68.1K$$

$$R2 = \frac{0.8 \times R1}{V_{out} - 0.8} \quad (\text{sets output voltage})$$

$$CZ3 = \frac{1}{ZSF \times R1 \times \frac{1}{\sqrt{LC}}} \quad (\text{sets first zero})$$

$$RZ2 = \frac{\left((6.28 \times fc)^2 \times L \times C_{out} \right) + 1}{6.28 \times fc \times CZ3} \times \frac{V_{ramp}}{V_{in}} \quad (\text{sets the cross-over frequency, } fc)$$

$$CZ2 = \frac{1}{ZSF \times RZ2 \times \frac{1}{\sqrt{LC}}} \quad (\text{sets second zero})$$

$$CP1 = \frac{1}{6.28 \times f_s \times RZ2} \quad (\text{sets first high-frequency pole})$$

$$RZ3 = \frac{1}{6.28 \times f_s \times CZ3} \quad (\text{sets second high-frequency pole})$$

Where $ZSF = (f \text{ compensation double zero}) / (f \text{ circuit double pole})$
 Here ZSF is set at 0.8.

As a particular example, consider for the following SP6136EB, 7AMAX with a type III Voltage Loop Compensation component selections:

$$V_{in} = 12V$$

$$V_{out} = 3.30V \text{ @ } 0 \text{ to } 7A \text{ load}$$

Select $L = 2.2 \mu H \Rightarrow 30\%$ current ripple.

Select $C_{out} = 100\mu F$ Ceramic capacitor ($R_{esr} \approx 5m\Omega$)

$f_s = 600KHz$ SP6136ER1 internal Oscillator Frequency

$V_{ramp_pp} = 1.0V$ SP6136ER1 internal Ramp Peak to Peak Amplitude

Step by step design procedures:

- a. **R2** = 21.8kΩ
- b. **CZ3** = 272pF
- c. **Let fc** =80kHz then:
- d. **RZ2** = 34.4kΩ
- e. **CZ2** = 538pF
- f. **CP1** = 7.7pF
- g. **RZ3** = 0.97kΩ
- h. **CF1** = 22pF to stabilize SP6136ER1 internal Error Amplify

The above component values were used as a starting point for compensating the converter and after laboratory testing the values shown in circuit schematic of page 1 were used for optimum operation.

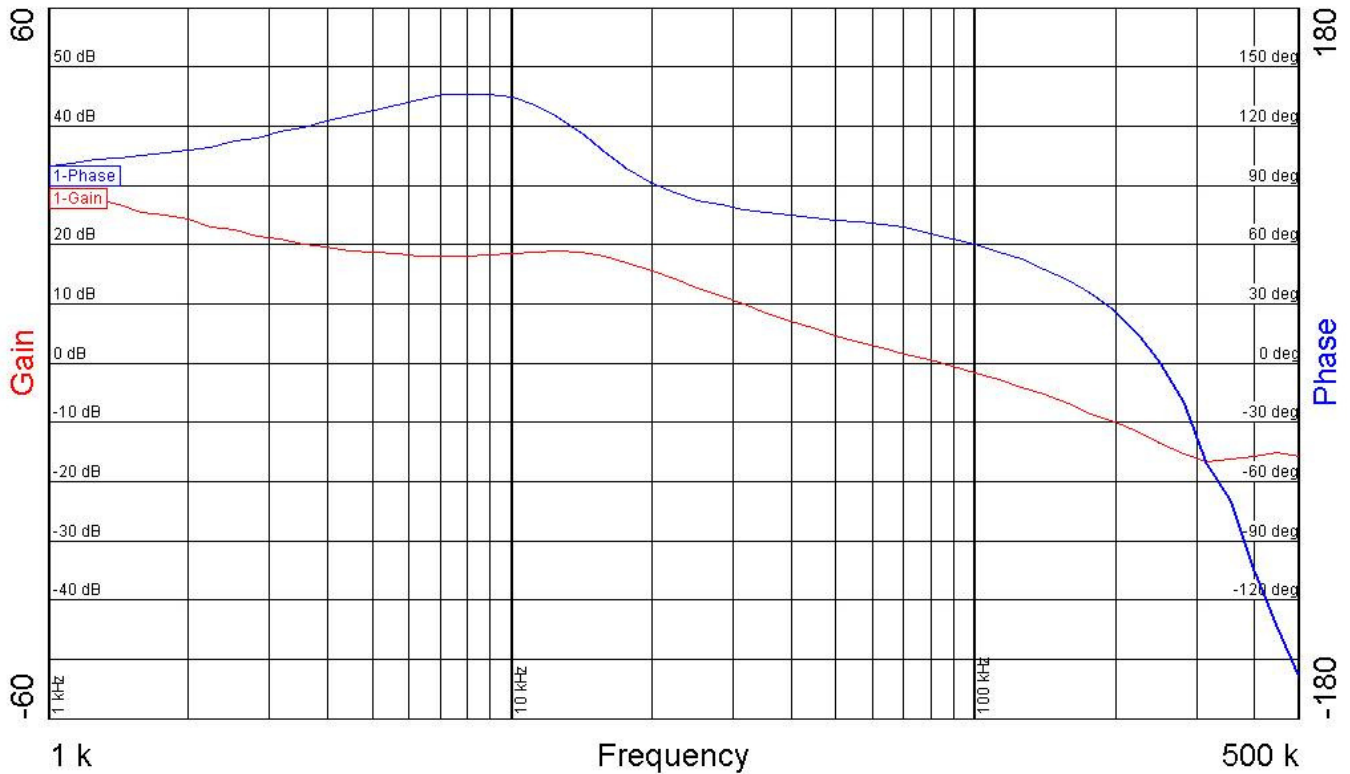

Figure 12- Gain/Phase measurement of SP6136EB shown on page 1, cross-over frequency (fc) is 85KHz with a corresponding phase of 65 degrees

PCB LAYOUT DRAWINGS

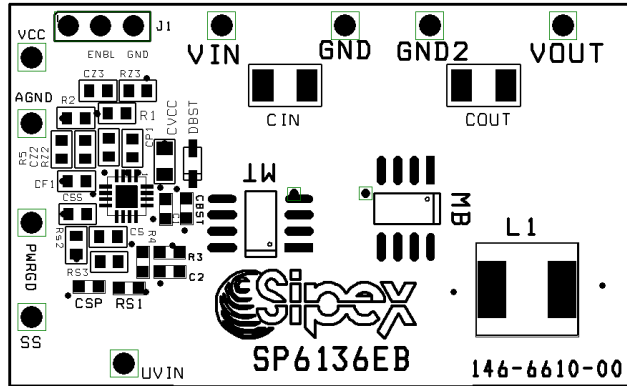

Figure 13. SP6136EB Component Placement

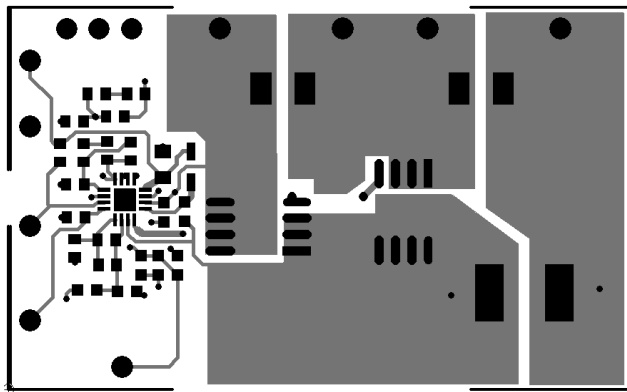

Figure 14. SP6136EB PCB Layout Top Side

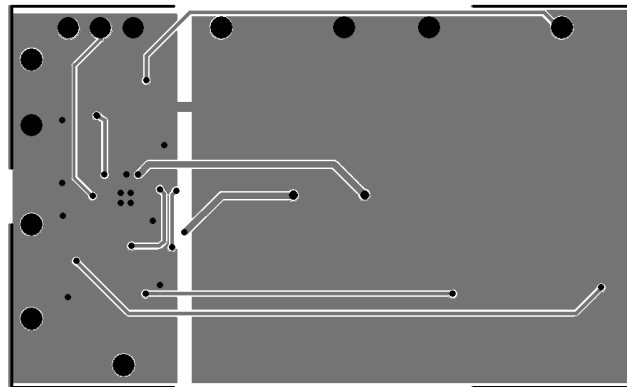

Figure 15. SP6136EB PCB Layout Bottom Side

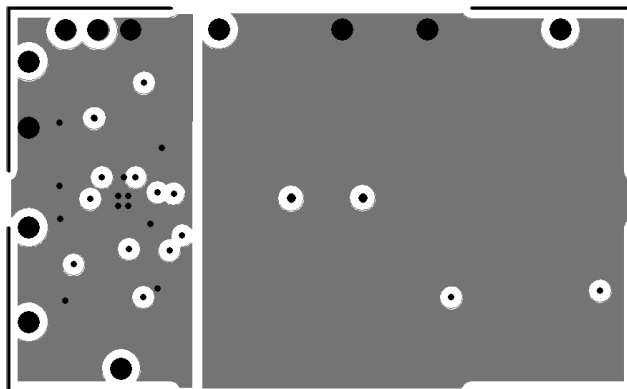

Figure 16. SP6136EB PCB Layout Inner Layer 1 & Inner Layer 2

Table 2: SP6136EB List of Materials

Line No.	Ref. Des.	Qty.	Manuf.	Manuf. Part Number	Layout Size	Component	Vendor Phone Number
1	PCB	1	Sipex	146-6610-00	1.175"x1.934"	SP6136EB	978-667-7800
2	U1	1	Sipex	SP6136ER1	QFN-16	Synchronous Buck Controller	978-667-7800
3	MT	1	Vishay Semi	Si4354DY	SO-8	NFET, 30V, 18.5mOhm	402-563-6866
4	MB	1	Vishay Semi	Si4886DY	SO-8	NFET, 30V, 13.5mOhm	402-563-6867
5	L1	1	Inter-Technical	SC7232-2R2M	7.2x6.6mm	2.2uH Coil 13A 10.4mOhm	914-347-2474
6	DBST	1	Vishay Semi	SD101AWS	1.5x4.6mm	Schottky, 60V	402-563-6866
7	C1, CBST, CS	3	TDK	C1608X7R1C104K	0603	0.1 uF Ceramic X5R 16V	978-779-3111
8	CSP	1	TDK	C1608JB1H682K	0603	6.8nF Ceramic X5R 50V	978-779-3111
9	CIN	1	TDK	C3225X5R1C226M	1210	22uF Ceramic X5R 16V	978-779-3111
10	COU	1	TDK	C3225X5R0J107M	1210	100uF Ceramic X5R 6.3V	978-779-3111
11	CVCC	1	TDK	C2012X5R1A475K	0805	4.7uF Ceramic X5R 10V	978-779-3111
12	C2	1	TDK	C1608X7R1E103J	0603	0.01uF Ceramic X7R 25V	978-779-3111
13	CSS	1	TDK	C1608X7R1E473K	0603	47nF Ceramic X7R 25V	978-779-3111
14	CP1	1	TDK	C1608CH1H120J	0603	12pF Ceramic COG 50V	978-779-3111
15	CZ2	1	TDK	C1608CH1H561J	0603	560pF Ceramic COG 25V	978-779-3111
16	CF1	1	TDK	C1608CH1H220J	0603	22pF Ceramic COG 50V	978-779-3111
17	CZ3	1	TDK	C1608CH1H271J	0603	270pF Ceramic COG 50V	978-779-3111
18	R1	1	Panasonic	ERJ-3EKF6812V	0603	68.1K Ohm Thick Film Res 1%	800-344-4539
19	R2	1	Panasonic	ERJ-3EKF2152V	0603	21.5K Ohm Thick Film Res 1%	800-344-4539
20	R3, R4		Not populated				
21	R5	1	Panasonic	ERJ-3EKF1002V	0603	10.0K Ohm Thick Film Res 1%	800-344-4539
22	RZ2	1	Panasonic	ERJ-3EKF3092V	0603	30.9K Ohm Thick Film Res 1%	800-344-4540
23	RZ3	1	Panasonic	ERJ-3EKF1001V	0603	1K Thick Film Res 1%	800-344-4539
24	RS1, RS2	2	Panasonic	ERJ-3EKF5111V	0603	5.11K Ohm Thick Film Res 1%	800-344-4540
25	RS3	1	Panasonic	ERJ-3EKF2002V	0603	10K Ohm Thick Film Res 1%	800-344-4541
26	J1	1	Sullins	PTC36SAAN	.32x.12	36-Pin (3x12) Header	800-344-4539
27	(J1)	1	Sullins	STC02SYAN	.2x.1	Shunt	800-344-4539
28	VIN, VOUT, VCC, GIN, GO, GND, SS, PWRGD, UVIN	9	Vector Electronic	K24C/M	.042 Dia	Test Point Post	800-344-4539

ORDERING INFORMATION

Model	Temperature Range	Package Type
SP6136EB.....	- 40°C to +85°C.....	SP6136 Evaluation Board
SP6136ER1.....	- 40°C to +85°C.....	16-pin QFN