

LTC6803-4 Battery Monitor

HARDWARE/SOFTWARE DEMONSTRATION BOARD MANUAL

DESCRIPTION

Evaluation circuit DC1835A is a Battery Monitoring System to demonstrate the functional operation of the **LTC6803-4** integrated circuit. The design includes the ability to bus up to 10 devices with built-in board-to-board ribbon-cable interconnects and selectively apply resistive loading to any cell for purposes of “Passive Balancing.” Additionally, the board includes a DC-DC boost conversion section to power the IC from an isolated external 5V supply. The external 5V supply also powers a data isolator so that the user SPI data bus is floating with respect to the monitored cells.

LTC6803-4 KEY FEATURES

- Separate Cell 0 ADC input (bottom-cell connection).
- Conversion range down to -300mV per cell.
- Addressable SPI interface (up to 16 devices).
- Packet Error Checking on command writes.
- 6X lower standby current than LTC6802.
- Power-down mode for “no battery drain”.
- Active pullup on discharge-control outputs (S pins).
- Extensive diagnostic commands.

DC1835A DEMO FEATURES

- Fully isolated data and power interface- no powering from cells.
- On-board 54V boost supply.
- Controllable discharging for Passive Balancing.
- Graphical User Interface (GUI) screen for demonstration of new features and program code development.
- Dual SPI connectors for interconnecting multiple boards

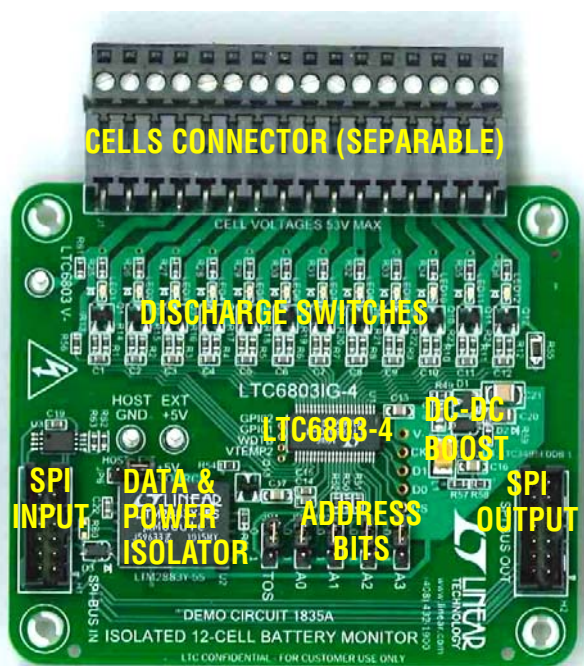

GETTING STARTED WITH ONE BOARD CONNECTED

SINGLE BOARD CONNECTION TO PC AND GUI

Step 1. Set jumpers on DC1835A to the default positions indicated in Table 1.

TABLE 1. JUMPER FUNCTIONS

JUMPER	FUNCTION	DEFAULT POSITION	DEFAULT POSITION	ALTERNATIVE POSITION
JP1	Top of Stack (TOS)	1	Indicates that the cells monitored by the board are at the top of the battery stack to provide primary toggle polling. Only one device should form the toggle frequency.	Forces device into the secondary toggle polling mode.
JP2-JP5	A0, A1, A2, A3 (address)	0	Sets hexadecimal address nibble to 0x0	Setting bits to 1 configures different device addresses. Used in the event there are multiple LTC6803-4 in a SPI bus.
JP6	+5V Source	EXT	Power is furnished by the External 5V turret connections.	Power is taken from the SPI BUS IN connection.

Step 2. Connect an un-energized 5V supply to the External 5V power turrets (labeled EXT +5V and HOST GND). The supply will have the same ground potential as the ribbon signals in the SPI bus.

Step 3. Power up 5V supply. Current draw should be about 22mA.

Step 4. Connect DC590B Quick Eval USB cable to PC/Laptop USB port. Connect ribbon cable from DC590B to the SPI BUS IN port of DC1835A (H1). Make sure that the driver for DC590B has been downloaded from www.linear.com and installed on the computer. This can be verified by running Quick Eval and seeing the message that there is a missing module for this board type. Close the Quick Eval program and then launch only the control program:

LTC6803-2-4_GUI_Vxx_yyyymmdd.exe

When the DC590B Quick Eval board recognizes the String ID code from the DC1835A board, the program will open and present the control screen. This sometimes requires two launches of the GUI program to properly initialize.

A DC590B board has a required pull-up resistor for the SDO line already connected. **If a system other than DC590 is driving the SPI interface, there must be a pull-up resistor installed in location R60 (0603 size, 2KΩ to 5KΩ is suitable).** This pull-up resistor was not added to the DC1835A because it would demand too much drive current for bussed operation on a multiple board setup.

Step 5. Connect the cells to be monitored to the cells connector J1. This connector is in two pieces. The setscrew piece can be unplugged to make it safer to attach wiring from a three to twelve cell battery stack. The LTC6803-4 is intended to measure from three to twelve individual cells with a total stack voltage of 9V to 51V.

With fewer than 12 cells to be monitored, the bottom cell of the stack should always be connected as Cell 1 between terminals J1-5(+cell contact) and J1-4(-cell contact). Terminal J1-4, is the Cell 0 reference point for the battery cell stack. The second cell on the stack connects between terminals J1-6(+cell contact) and J1-5(-cell contact). All higher numbered terminals on J1 not used for cell connections may be shorted together with the top po-

tential or left open. Figure 1 illustrates a connection for fewer than 12 cells.

SPECIAL NOTE FOR DEMONSTRATION PURPOSES

DC1835A and the GUI program are useful to serve as a demonstration tool to highlight the features of the LTC6803-4. If actual battery cells are not available, a series string of 150Ω resistors connected between each of the J1 connector terminals can be used instead. Each resistor will serve as a cell voltage. A lab power supply voltage of 9V to 51V can be connected across the resistor string between terminals J1-16(+) and J1-4(-).

When using resistors instead of cells, the discharge indicating LEDs on the DC1835A board may not light due to limited available current in the resistor-string.

Step 6. Mate the J1 battery connector.

Inserting the setscrew piece into connector J1 will apply signals to the board from the battery cell stack. For the demo set up simply turn on the lab power supply preset to a voltage between 10V and 50V.

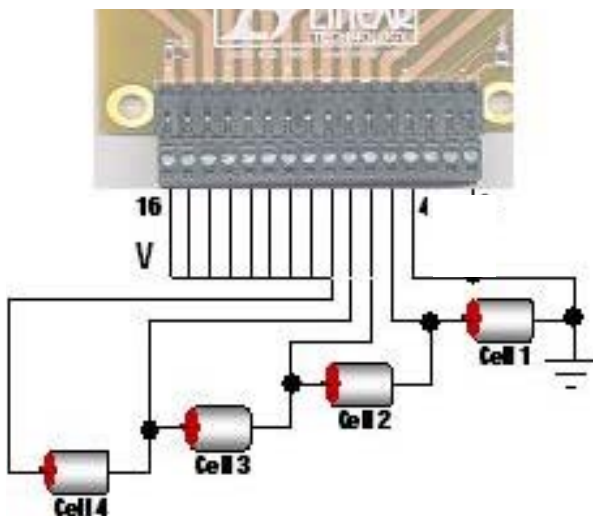

Figure 1. Typical connection of four cells.

THE CONTROL PROGRAM

THE GRAPHICAL USER INTERFACE (GUI) SCREEN

Figure 2 shows the control panel that appears on the computer screen. The DC1835A board must be connected to the DC590 interface card for the program to open. The control screen will close if any of the boards are disconnected. Controls on this panel are used to communicate with the LTC6803-4. Commands are issued and information is retrieved and displayed on this screen. This panel is useful not only for demonstrating

the operation of the LTC6803-4, but also for software developers to observe the Hex codes exchanged with the device.

The control screen makes good use of color to provide cell status and operating conditions at a glance. White indicates non-existent or stale data. A step by step procedure for one board connected to a stack of cells follows to explain the operation of the control panel. Sections are highlighted for each procedure.

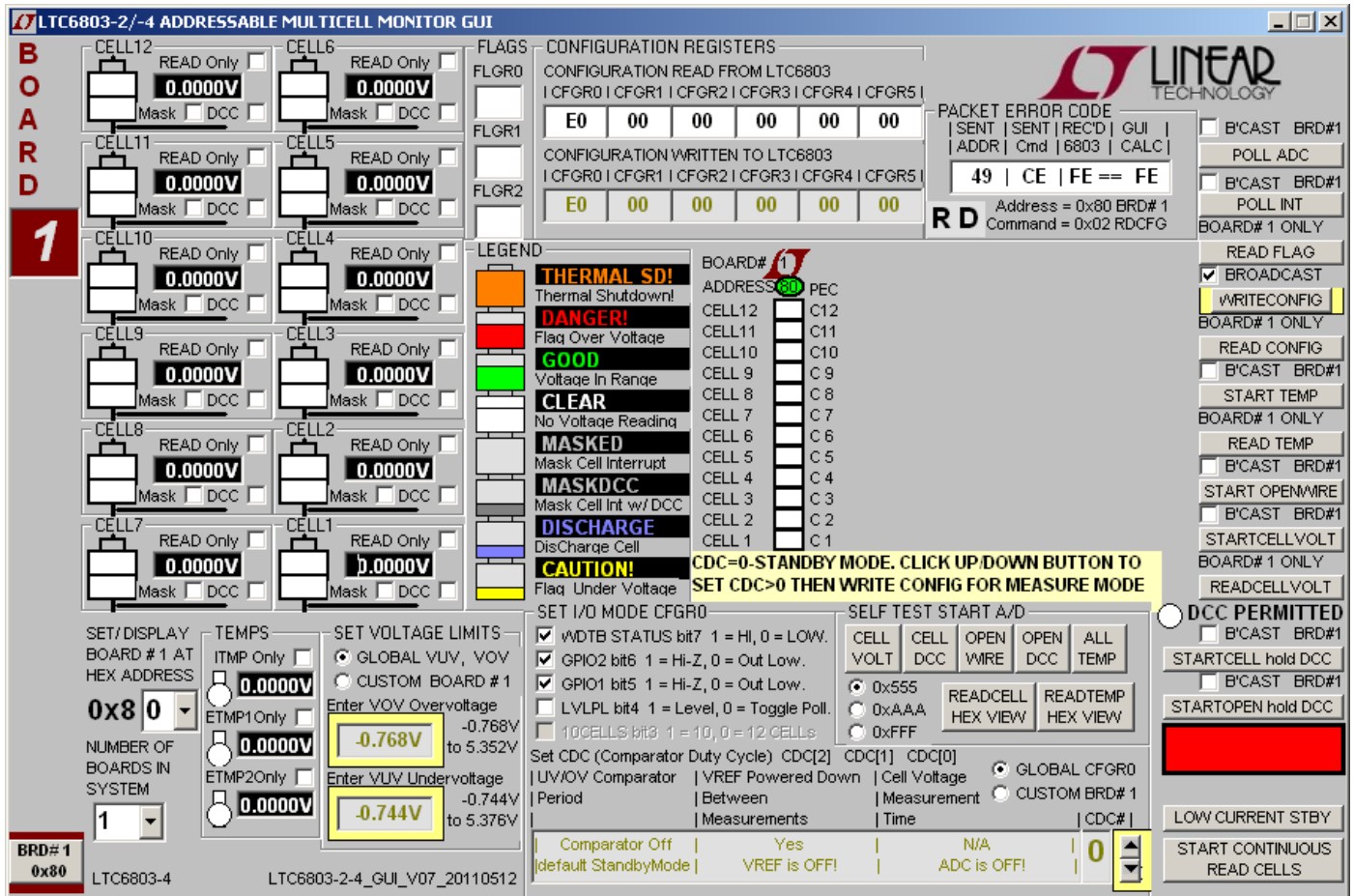

Figure 2. GUI Control Panel Start-up Screen

OPERATING THE CONTROL SCREEN

FIRST THINGS FIRST

Figure 2 is the initial start-up screen that appears when the program is launched and the Quick Eval interface card recognizes that the DC1835A board is connected. Once 5V power is supplied to the board, the communication between the PC and the board can be checked. The DC590 may partially power the circuit via the SPI signals, but this is not a recommended practice.

1: READ CONFIGURATION

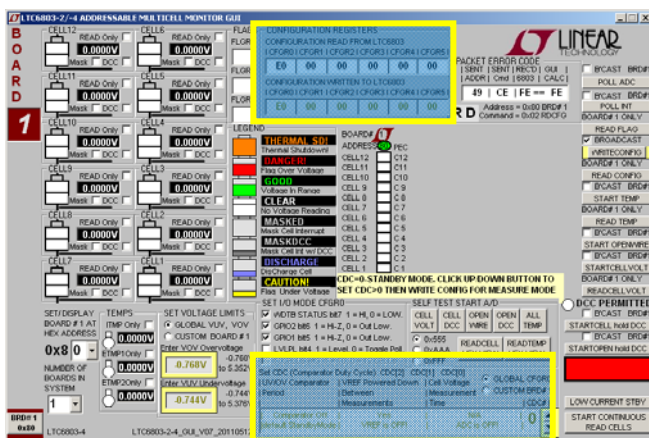

Click the command button labeled **READ CONFIG**. If all is properly connected and operating the start-up default configuration of the LTC6803-4 will be read from the board. The Hex codes for the six bytes of configuration setting will appear in the **CONFIGURATION REGISTERS** section in the boxes labeled **CONFIGURATION READ FROM LTC6803**. The initial configuration bytes should be 0xE0 for register 0 and 0x00 for the other five bytes. **This default configuration is the standby mode for the LTC6803. To enable the device and begin taking cell voltage measurements, a CDC (Comparator Duty Cycle) setting other than Standby (like CDC=1) must be selected from the SET I/O MODE set CDC selection box at the bottom of the GUI screen. Once chosen, a WRITE CONFIG command must be executed.**

In addition the LTC6803 calculates a Packet Error Code, PEC, and appends it to the data stream each time it sends out data. For the six bytes sent by this

command and received by the GUI, the control program calculates a PEC in the same manner. This byte is compared with the appended receive byte to check that the data transmission was properly executed. The Received PEC byte and the calculated PEC from the received data are displayed in the top section labeled **PACKET ERROR CODE** and both bytes should match. The oval located at the top of the color-coded status panel for the one board will turn green if the PEC bytes match. Data transmission errors will produce red warning indications if the PEC bytes do not match. There is also a display of the PEC that was sent with the most recent command to the LTC6803, which had to match an internally calculated value to be accepted as a valid command.

2: WRITE CONFIGURATION

Nothing is changed within the LTC6803 until the Write Configuration command is executed. Clicking the **WRITE CONFIG** command button does this. When the command is sent, the six Hex bytes shown in the **CONFIGURATION REGISTERS** section in the boxes labeled **CONFIGURATION WRITTEN TO LTC6803** will become **bold** type. Software developers can note the exact hex values required by the LTC6803 for specific conditions in these boxes to facilitate their control program development.

Clicking the **READ CONFIG** button can see confirmation that the configuration change was actually made. The six bytes read back should match the six bytes sent and the PEC/CRC check bytes should be a match (green PEC oval on stack display).

When any configuration information is changed on the screen the **WRITE CONFIG** command button will be back-lit illuminated. This serves as a reminder that this command still needs to be executed.

IMPORTANT NOTE

No configuration changes take effect until the WRITE CONFIG button is clicked. The GUI provides a periodic background command so that watchdog does not trigger a CDC reset back to 0.

3: PROGRAM THE CELL MONITORING VOLTAGE THRESHOLDS

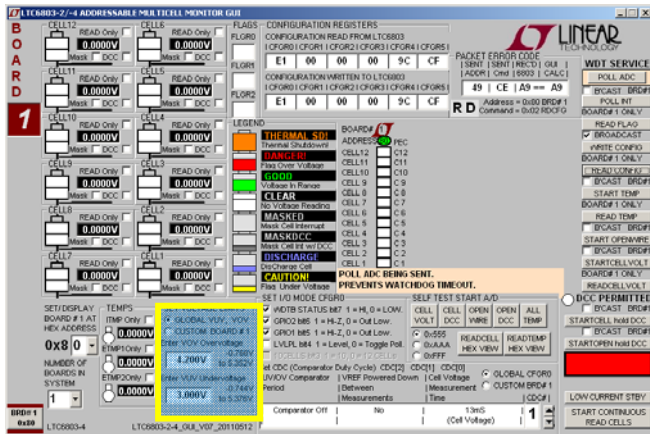

In the section labeled **SET VOLTAGE LIMITS** click on the boxes and enter voltage values for the over-voltage and under-voltage thresholds required for the cells being monitored. The voltage value entered will be rounded to the actual value used by the LTC6803 and displayed in the box. The voltage ranges for these thresholds is -0.74V to 5.35V and the program will not allow the under-voltage to be greater than the over-voltage threshold.

These monitor thresholds can be applied globally to each and every cell in the system or customized for the cells connected to an individual board by clicking the desired option button. Individual boards are selected for programming by the left hand tabs in multiple board systems.

4: READ CELL VOLTAGES

The essential function of the LTC6803 is to measure and report the voltage on each battery cell when commanded. Once again this is accomplished from the control screen with two command button clicks. First click on the **START CELL VOLTAGE** button. This commands an A/D conversion of all 12-cell voltages in the time configured from the selected Set CDC option in the **SET I/O MODE** box. The actual cell voltage measurements are not displayed until the **READ CELL VOLTAGE** command button is clicked.

5: READ FLAGS

When any cell in a stack exceeds the programmed over or under voltage threshold limit, one of two flag bits is set in an internal register for that cell to serve as a warning. This is important feedback for battery charging algorithms to know when to start or stop charging. To read the state of these warning flags at any time is a simple click of the **READ FLAG** command button. The Hex code for the three flag bytes appears in the **FLAG REGISTERS** section of the control panel.

One of the configuration options is to mask these flags from appearing in the register bytes that are read from the LTC6803. This feature can be used to prevent or allow these flags to affect a control algorithm. A check box is provided for each cell in a stack to select the mask interrupt option for that cell. To implement the masking requires checking the box and then writing the new configuration with a **WRITE CONFIG** button push.

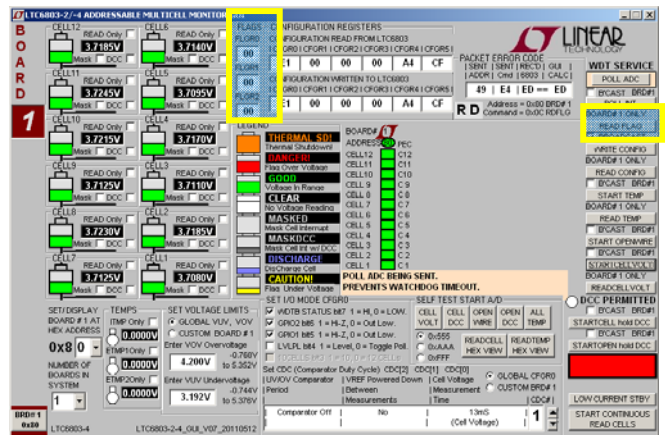

If the measured voltage of a cell is within the monitoring thresholds all indications for the cell appear green.

5: READ TEMPERATURE

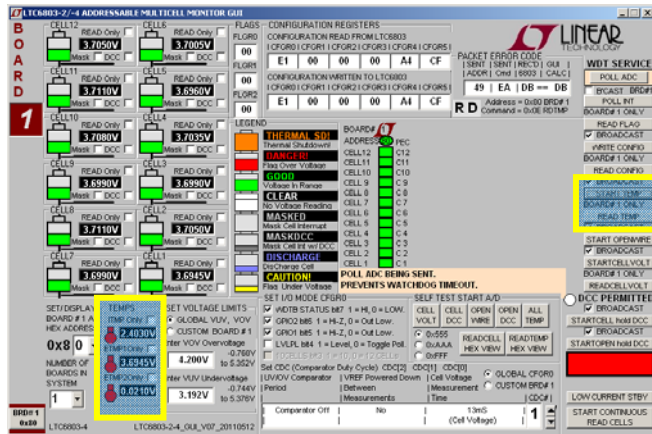

The LTC6803 has three ADC channels dedicated to measuring temperature. The temperature indications are for the internal die temperature of the LTC6803 and two external signals, typically from thermistors. The display returns a voltage measurement.

The internal die temperature sensor produces a voltage that changes at a rate of 8mV/°C relative to absolute zero. To convert the voltage reading to degrees Celsius, divide the voltage by 8mV then subtract 273°C. For example, 25°C is a nominal reading of 2.384V.

The DC1835A dedicates ETMP1 (data from the VTEMP1 pin) to a measurement of the full-stack voltage. The 1:12 resistor divider comprising R54 and R55 places a down-scaled signal on VTEMP1 when FET Q13 is activated by power-up of the circuitry. The VTEMP2 pin is brought out to a solder-pad for user wiring to an external signal of interest. The VTEMPx inputs are converted with respect to V- of the LTC6803 and have comparable accuracy to a cell conversion.

To take a temperature reading simple click the **START TEMP** command button to make the LTC6803 ADC conversion followed by clicking the **READ TEMP** command button to download the data from the board and display the voltage readings.

6: READ AN INDIVIDUAL CELL OR TEMPERATURE

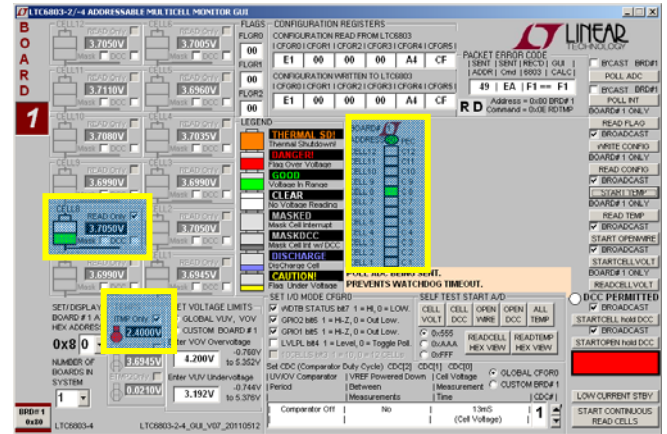

Each cell and each temperature channel has a check box to allow individual measurements. Checking these “Only” boxes config the command (**STARTCELL VOLT** then **READCELL VOLT**, **START TEMP** then **READ TEMP**) to read only that channel and display its status. Cell 8 and Internal Temp are shown in the example screen above. Older or stale readings for all other cells and temperatures are faded out.

8: DISCHARGE CELLS

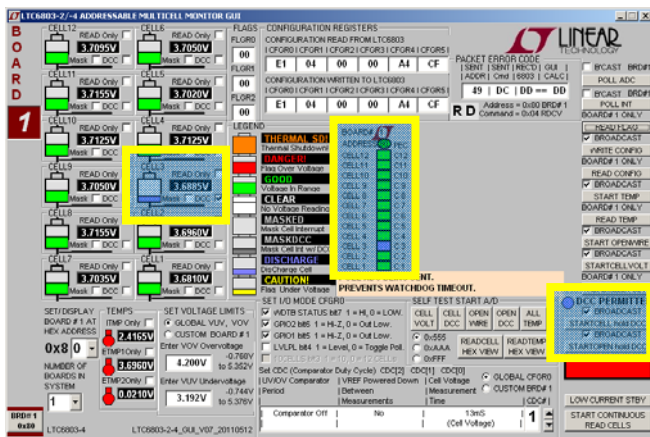

Another major feature of the LTC6803 is the ability to remove charge from individual cells. This can help to distribute the cell charge evenly over a stack of batteries. DC1835A contains a P channel Mosfet in series with a 33Ω resistor across each cell connection. When enabled, a cell is loaded and charge is pulled from the cell with energy dissipated in the switch, resistor, and green LED.

A check box is provided for each cell to be discharged. Checking this box (Cell 3 in the above example screen shot) and then writing the new configuration with a **WRITE CONFIG** button push will load the cell.

IMPORTANT NOTE: The discharge transistors are automatically turned off momentarily while the A/D converter is measuring the cell voltage using the normal **STARTCELL VOLT** command. This prevents any voltage drop errors caused by the discharge current flowing through the cell inter-connection wiring. An accurate indication of the true state of charge of the cells is then obtained.

The LTC6803 offers the option of keeping the discharge transistors on while measuring the cell voltages. This is done using the **STARTCELL hold DCC** command button. A blue indicator is illuminated when this command has been executed. This lower voltage reading also includes I*R errors introduced by cabling and connectors.

OTHER CONTROL FEATURES

Three additional command buttons are provided on the control screen. The **POLL ADC** and **POLL INTERRUPT** command buttons are used to test if the ADC is busy making conversion and to test if any of the LTC6803 devices in a system have an interrupt condition respectively. The result of these commands can be observed by monitoring the serial data output (SDO) line of the SPI interface at J2 (or J3 or J4 if a data isolator is used as described on pg. 10). There is no indication provided on the control screen.

The **START OPENWIRE** command button connects the built in open wire detection circuitry to all cells. This command must be followed by **READCELL VOLT** command button click to see the result. An open wire connection to any cell will be indicated by an abnormally high voltage measurement for the cell above the open wire and a near 0V measurement for the cell with the open wire.

CONTINUOUS OPERATION

For convenience, the control panel allows for continuous operation of the DC1835A board. The command button labeled **START CONTINUOUS READ CELLS** can be clicked and the board control is placed in a continuous loop executing the following commands automatically in the following sequence:

- Start cell voltage
- Read cell voltage
- Start temp
- Read temp
- Read flags

All values are updated continually (~800ms update rate). While running, the configuration can be changed on the fly. Simply changing a configuration item (Discharge cells for example) and clicking the **WRITE CONFIG** button will implement the new configuration and return to continuous operation.

A green box in the lower right hand corner indicates that the system is running continuously. A red box means that the system is stopped and waiting for a new command to be sent.

DISPLAYING VALID DATA TRANSFERS ONLY

Each time data is transferred from the LTC6803 by the four READ commands (Cell Voltage, Configuration, Flag Status and Temperature), a Packet Error Code, PEC, is appended based on the data stream sent. The control program also calculates a PEC value based on the data it receives. If the calculated PEC matches the transmitted value the data transfer is assumed to be error free and therefore the data is valid.

If the two PEC values do not match, the transmitted data stream has been somehow corrupted. This type of data error becomes more of a concern when boards are stacked and the transmit data stream is lengthened. The transmitted and calculated PEC values are displayed on the GUI and turn red when a mismatch occurs.

LOW CURRENT STANDBY

An important system consideration is the ability to put the monitoring circuitry into a low current drain condition. This is done by setting the LTC6803 into its standby configuration. A command button in the lower right corner of the screen is provided to facilitate this function. Once pushed all data and configuration settings are reset and the screen goes white on all indicators. While this minimizes the dissipation within the IC, the bulk of the DC1835A power is to operate the SPI isolator. To bring the power of the entire circuit to essentially zero, the SPI lines should go low and the external 5V turned off. Since power is never drawn from the cells (other than microamp-level ADC currents), there will not be meaningful battery drain unless discharge action is commanded.

SELF TEST & DIAGNOSTIC FUNCTIONS

The LTC6803 has built in self test and diagnostic functions. These commands apply a test signal to the ADC to check that the internal cell voltage and temperature connections are functioning. The cell voltage and open

wire test signals can be applied with or without the discharge transistors active. Checking the functionality of each bit in the internal data registers for cell voltages and temperatures can also be seen by choosing which test code (0x555, 0xAAA, or 0xFFFF) to expect to be returned from the device when a self test command is issued. Self testing must use CDC mode 1 for correct results. Tests are initiated with the various ADC command buttons in the self test part of the GUI. The results can be viewed in hexadecimal with the neighboring buttons.

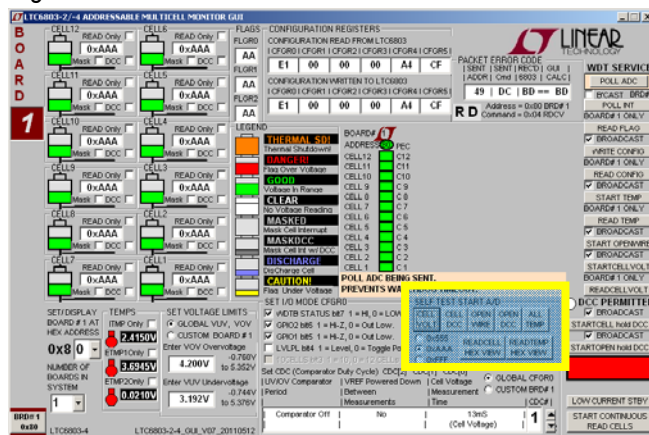

OTHER CONFIGURATION OPTIONS

The SET I/O MODE group of checkboxes can be used to adjust other features of the LTC6803. Configuring the general purpose I/O pins and setting the type of activity polling scheme can be selected then configured with a WRITE CONFIG button push.

EXTERNAL POWER FUNCTIONS

The DC1835A includes DC-DC conversion technology that provides isolated +5V, +12V, and -12V from the external 5V source using the LTM2883-5S data isolator. The V+ of the LTC6803 is powered by 54V generated by an LTC3495-1 boost circuit running off the isolated +12V. Powering down the external 5V and SPI signals de-powers the entire circuit. A jumper (JP6) configures the external source connection as either from the EXT +5V turrets, or from the SPI BUS IN connector. Since the DC590 cannot reliably furnish the requisite power for the DC1835A, the EXTERNAL setting and a dedicated 5V supply should be used with the first board in a typical setup.

SETTING UP MULTIPLE BOARDS

ADD BOARDS TO MEASURE MORE CELLS

Since the DC1835A are equipped with data isolators and a host-side SPI bus configuration, the circuits have the ability to communicate to the host along with up to 15 other DC1835A boards, monitoring up to 12 cells each. The control GUI however is limited to only 10 boards (120 cells maximum). In a multi-board setup, the power from the first board can be furnished to subsequent boards through the SPI BUS OUT connector. To stack and control more than one board requires the following hardware and software modifications:

MULTI-BOARD HARDWARE ADJUSTMENTS

1. All boards will require the use of external 5V power. The external power can be shared amongst boards, as the host interfaces will all be at the same potential. To share power from the first DC1835A, all but the first board should use the HOST position for JP6. Each board typically uses 26mA when operating and the one 5V supply at the first board can power all the boards in this way.
2. The bottom board on the stack, which connects to a system controller or to a DC590 Quick Eval link to a PC, must use the SPI BUS IN connector (H1) as the primary interface. **If not using DC590, a 2K Ω to 5K Ω pull-up resistor must be connected from the SDO output line (connector H1, pin 5) to the 3V/5V logic power rail of the circuit driving the SPI port. For convenience, the 0603 size footprint R60 provides this option.**
3. The final board on the top of the stack should have JP1 (TOS) set to 1. Connect JP1 (TOS) on all other boards to the 0 position.
4. A ribbon cable must connect the SPI BUS OUT (H2) of a lower board to the SPI BUS IN (H1) of the next board up on the stack. The daisy chain linking with ribbon cables from the output port of a lower board on the stack to the input port of the next board above it establishes the data link bus for the entire stack.
5. Configure the boards to have unique addresses. JP2-JP5 set the binary address bits A0-A3 respectively. The GUI can accommodate arbitrary address assignments, but by default will set addresses incrementally ascending from 0 up to board count minus 1, so setting the boards accordingly is the easiest and least confusing setup.
6. Since all the DC1835A are all powered externally, they can be powered up and exercised even without any cell connections, though only readings near zero will be obtained from any floating ADC inputs.

CAUTION! CAUTION! CAUTION!

As battery cells are stacked on top of each other, great care must be taken to prevent damage and personal injury from the very high voltage potentials that may be present. Do not allow short circuit connections, whether electrical or human, between a high voltage point and the system or chassis ground at the bottom of the stack. Be very careful and respect the potential danger of high voltage!

SOFTWARE ADJUSTMENTS

The GUI program can control up to ten boards on a stack.

1. Select the number of boards on the stack from the pop up window located near the command buttons at the bottom of the screen.
2. A tab will appear on the left edge of the control panel for each board on the stack. Clicking on any of these tabs will transfer control commands and data to and from the display screen to that selected board. Each board must have a unique address nibble selected. The address nibble must match the settings of the address jumpers JP2-JP5 (in hexadecimal).
3. Select whether the Operating Configuration (CDC Comparator) and Over/Under voltage thresholds for each board are to be the same (GLOBAL) or different for each board (CUSTOM) and set the duty cycle and voltages accordingly. CDC = 1 is recommended for most situations. Write configura-

tion(s) are then required to load the settings into the LTC6803 devices.

COLOR CODED STATUS PANEL

The color-coded status panel will expand to include all boards connected in a stack. Each small square in this array represents an individual battery in the stack of boards. The intent of this display is to provide a way to see the status of all cells at a glance. The significance of the colors used is explained in the legend on the screen.

Any grayed box indicates that the cell's interrupt flag has been masked so the LTC6803 is no longer reporting this status. The cell voltage value measured for this cell however is still accurate.

The next pages show the schematic and bill of material for DC1835A. Consult the LTC6803-4 data sheet for additional information.

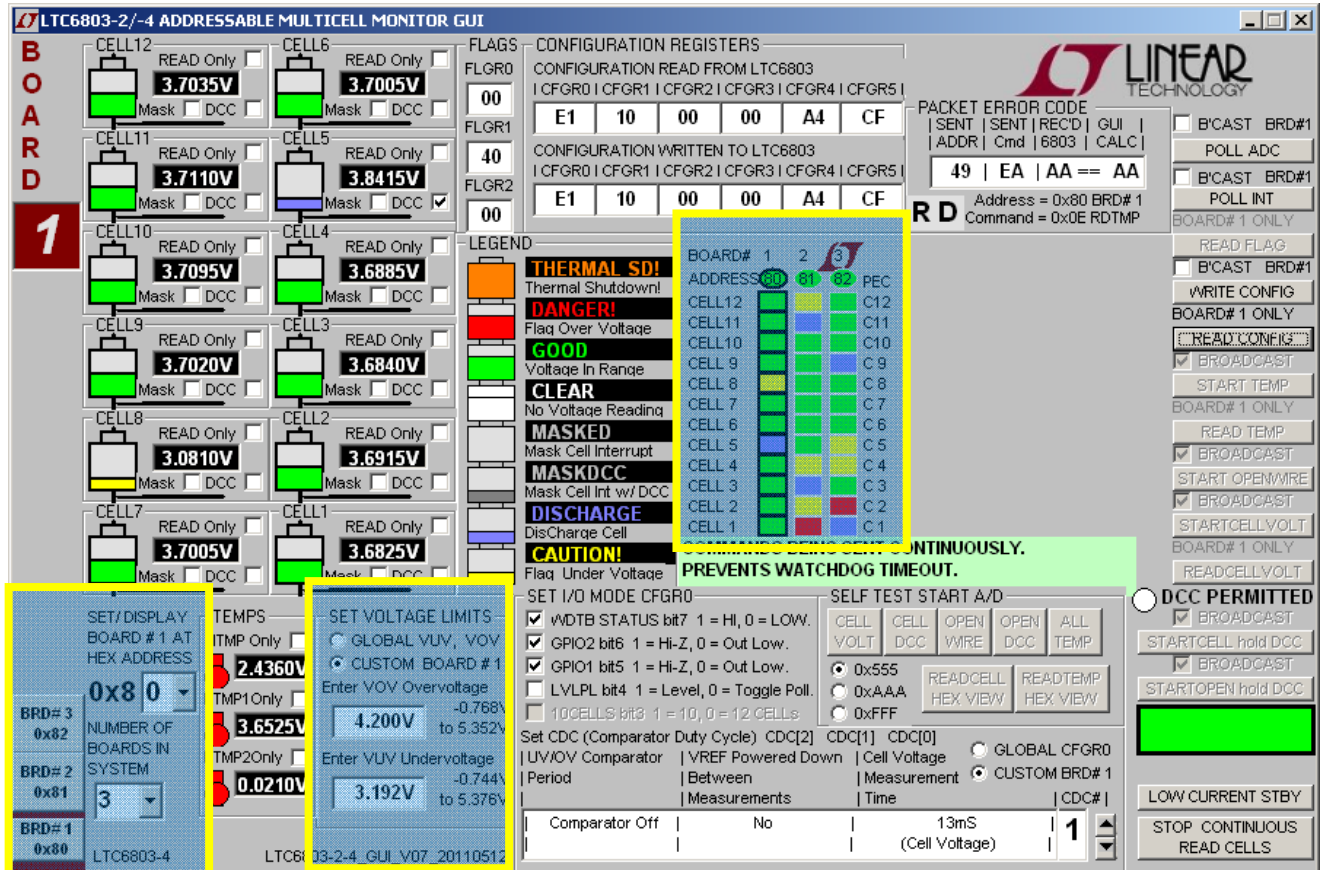

Item	Qty	Ref - Des	Desc	Manufacturer's Part Number
1	13	C1-C12,C19	CAP, 0603 100nF 10% 25V X7R	MURATA GCM188R71E104KA57D
2	1	C13	CAP, 0805 100nF 20% 100V X7R	MURATA GCM21BR72A104KA37
3	3	C14,C15,C22	CAP, 0603 1uF 10% 16V X7R	MURATA GCM188R71C105KA64D
4	1	C16	CAP, 0805 2.2uF 10% 25V X7R	MURATA GCM21BR71E225KA73
5	1	C17	CAP, 0805 4.7uF 10% 10V X7R	MURATA GCM21BC71A475KA73
6	1	C18	CAP, 0805 220nF 10% 50V X7R	MURATA GRM21BR71H224KA01L
7	1	C20	CAP, 1206 1uF 10% 100V X7R	MURATA GRM31CR72A105KA01L
8	1	C21	CAP, 1210 1uF 10% 100V X7R	TDK C3225X7R2A105K
9	1	D1	DIODE, SCHOTTKY	DIODES INC. BAT54S-7-F
10	2	D2,D3	DIODE, SCHOTTKY	ON SEMI. MBR0540T1G
11	3	E1,E2,E3	TURRET	MILL MAX 2308-2-00-80-00-00-07-0
12	6	JP1,JP2,JP3,JP4,JP5,JP6	HEADER,3PIN, 2mm	SAMTEC TMM-103-02-L-S
13	6	JP1,JP3,JP4,JP5,JP6,JP7	SHUNT	SAMTEC 2SN-BK-G
14	1	J1	HEADER, 1X16 3.5mm, HORIZ.	WEIDMULLER 1761682001
15	2	H1,H2	HEADER, 2X7 2mm	MOLEX 87831-1420
16	12	LED1-LED12	LED, 0603 GREEN	LITE-ON LTST-C190KGKT
17	1	L1	IND, 1210 10 uH 10 % 187 mA SMD	VISHAY IMC1210ER100K
18	4	MH1,MH2,MH3,MH4	STANDOFF, SNAP ON	KEYSTONE_8831
19	1	P1	CONN. MATING 1X16 3.5 HORZ	WEIDMULLER 1615770000
20	12	Q1-Q12	XSTR, MOSFET, P-CHANNEL	RENASAS RQJ0303PGDQAL1
21	1	Q13	XSTR, 2N7002 N-CHANNEL MOSFET	ON SEMI. 2N7002K
22	13	R1-R12,R49	RES, 0603 100 OHMS 1% 1/10W	NIC NRC06F1000TRF
23	12	R13-R24	RES, 0603 3.3k OHMS 5% 1/10W	NIC NRC06J332TRF
24	12	R25-R36	RES, 0603 475 OHMS 1% 1/10W	NIC NRC06F4750TRF
25	12	R37-R48	RES, 2512 33 OHMS 5% 1W	NIC NRC100J330TRF
26	5	R50,R51,R52,R57,R58	RES, 0603 1M OHMS 1% 1/10W	NIC NRC06F1004TRF
27	1	R53	RES, 0603 4.3k OHMS 5% 1/10W	VISHAY CRCW06034K30JNEA
28	1	R54	RES, 0603 10K OHMS 1% 1/10W	NIC NRC06F1002TRF
29	1	R55	RES, 1206 110K OHMS 1% 1/4W	VISHAY CRCW1206110KFKEA
30	1	R59	RES, 0603 3.24M OHMS 1% 1/10W	VISHAY CRCW060333M24FKEA
31	0	R60	RES, 0603 OPTION	OPTION
32	2	R56,R61	RES, 0603 0 OHM JUMPER	VISHAY CRCW06030000Z0EA
33	2	R62,R63	RES, 0603 4.99K OHMS 1% 1/10W	NIC NRC06F4991TRF
34	1	U1	IC, BATTERY MONITOR	LINEAR TECH. LTC6803IG-4
35	1	U2	MODULE, SPI ISOLATOR	LINEAR TECH. LTM2883Y-5S
36	1	U3	IC, 24LC025-1/ST	MICROCHIP TECH. 24LC025-1/ST
37	1	U4	IC, 650mA/350mA Micropower Low Noise Boost Converter	LINEAR TECH. LT3495EDDB-1