

Common Precautions for All MOS FET Relays

⚠ WARNING

Always turn OFF the power supply before wiring a Relay.
Not doing so may cause electrical shock.



Do not touch the current-carrying parts of the pin section of a MOS FET Relay while the power is being supplied.



An electrical shock may occur.

Precautions for Safe Use

- Do not apply overvoltages or overcurrents to the input or output circuit of the MOS FET Relay.
The MOS FET Relay may fail or ignite.
- Perform soldering and wiring correctly according to specified soldering conditions.
Using a MOS FET Relay with incomplete soldering may cause overheating when power is applied, possibly resulting in burning.

Precautions for Correct Use

●Derating

You must consider derating to achieve the required system reliability.

To use a MOS FET Relay with high reliability, consider derating the maximum ratings and recommended operating conditions, and allow sufficient leeway in designs based on testing operation in the actual application under the actual operating conditions whenever possible.

(1) Maximum Ratings

The maximum ratings must never be exceeded even instantaneously. This applies individually to each of the ratings. If any of the maximum ratings is exceeded, the internal parts of the MOS FET Relay may deteriorate or the chip may be destroyed. To ensure high reliability in using a MOS FET Relay, sufficiently derate the maximum voltage, current, and temperature ratings when designing the application.

(2) Recommended Operating Conditions

The recommended operating conditions are to ensure that the MOS FET Relay turns ON and OFF reliably. To ensure high reliability in using a MOS FET Relay, consider the recommended operating conditions when you design the application.

(3) Fail-safe Design

We recommend that you implement fail-safe measures in the design of the application if the failure of, deterioration of characteristics in, or functional errors in the MOS FET Relay will have a serious affect on the safe operation of the system.

●Countermeasures for static electricity

There is a risk of damage to internal elements and impairment of functionality if static electricity is discharged to the pins due to product handling or otherwise.

Reduce the generation of static electricity as much as possible, and implement appropriate measures to prevent charge accumulation near the product.

●Typical MOS FET Relay Driving Circuit Examples

The LED input side of the MOS FET is driven by current. If applying a Voltage, add resistance in series with the circuit, so the specified current is applied.

This resistance is referred as "LED current limiting resistance".

C-MOS

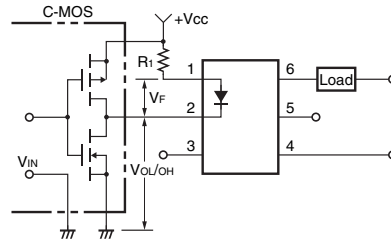

Transistor

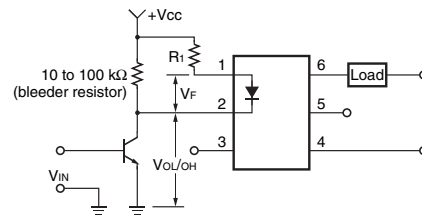

- To ensure that the MOSFET relay operates correctly, use the following formula to calculate the limiting resistance, and design the circuit accordingly.

$$R_1 = \frac{V_{CC} - V_{OL} - V_{F(ON)}}{I_F}$$

Note: To set the value of $I_{F(ON)}$, check the trigger LED current and recommended operation LED forward current indicated in the catalogue for each model, and set a high value with leeway.

- To ensure that the MOSFET relay resets reliably, calculate the reset voltage using the formula below, and control so that the voltage is lower than this value.

$$V_{F(OFF)} = V_{CC} - I_{FR} R_1 - V_{OH}$$

Note: For the $I_{F(OFF)}$ value, set a value that is lower with leeway than the reset LED forward current indicated for each model in the catalogue.

- If the drive transistor has a large leakage current that may cause malfunctioning, add a bleeder resistance.

●Protection from Surge Voltage on the Input Pins

- If any reversed surge voltage is imposed on the input pins, insert a diode in parallel with the input pins as shown in the following circuit diagram and do not impose a reversed voltage of 3 V or higher.

Surge Voltage Protection Circuit Example

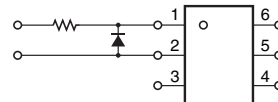

Common Precautions for All MOS FET Relays

●Protection from Spike Voltage on the Output Pins

- If there is an inductive load or other condition that will cause overvoltage that exceeds the absolute maximum rating between the output pins, connect a protective circuit to limit the overvoltage.

Spike Voltage Protection Circuit Example

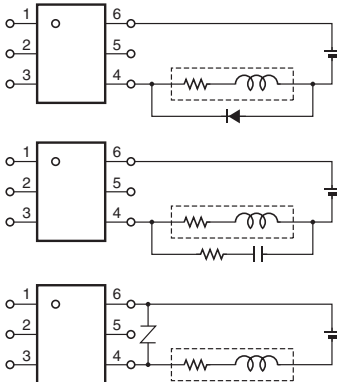

●Unused Pin

The unused pins of each MOSFET relay are used in the internal circuitry. Do not connect to an external circuit.

(Example for 6-pin Relay)

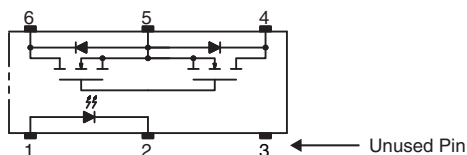

(Example of 8-pin high-capacity type)

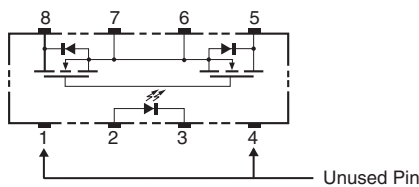

●Pin Strength for Automatic Mounting

- In order to maintain the characteristics of the MOS FET Relay, the force imposed on any pin of the MOS FET Relay for automatic mounting must not exceed the following limits.

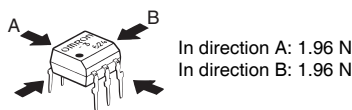

●Load Connection

- Do not short-circuit the input and output pins while the MOS FET Relay is operating or it may malfunction.

Example of correct connection

AC/DC connection (A connection)

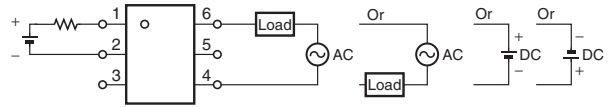

DC Single Connection (B connection)

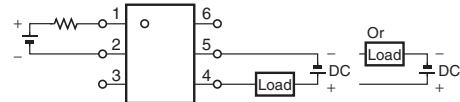
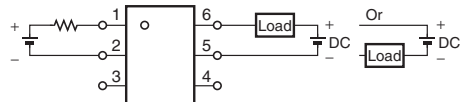

DC Parallel Connection (C connection)

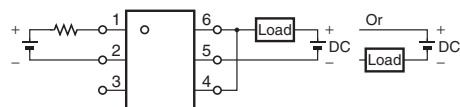

●Estimated Life

OMRON MOS FET Relays use mainly two types of LEDs. The service life is estimated separately for each type of LED.

The following tables show the LEDs that are used in each MOS FET Relay. Estimated life data is given on pages 3 and 4.

Ask your OMRON representative for any models that are not listed in the table.

This data is the results of estimating the service life from long-term data on a single lot. Use it only as reference data.

MOS FET Relays That Use GaAs LEDs

DIP	SOP	SSOP	SSOP
G3VM-61A1/D1	G3VM-21GR	G3VM-S5	G3VM-21LR
G3VM-61B1/E1	G3VM-21GR1	G3VM-201H1	G3VM-21LR1
G3VM-62C1/F1	G3VM-41GR4	G3VM-202J1	G3VM-41LR4
G3VM-2L/2FL	G3VM-41GR5	G3VM-351G	G3VM-41LR5
G3VM-351A/D	G3VM-41GR6	G3VM-351G1	G3VM-41LR6
G3VM-351B/E	G3VM-41GR8	G3VM-351GL	G3VM-61LR
G3VM-352C/F	G3VM-61G1	G3VM-351H	G3VM-81LR
G3VM-353A/D	G3VM-61G2	G3VM-352J	G3VM-101LR
G3VM-353B/E	G3VM-61GR1	G3VM-353G	USOP
G3VM-354C/F	G3VM-61H1	G3VM-353H	G3VM-21PR10
G3VM-355CR/FR	G3VM-62J1	G3VM-354J	G3VM-21PR11
G3VM-WL/WFL	G3VM-81G1	G3VM-355JR	G3VM-41PR10
G3VM-401A/D	G3VM-81GR	G3VM-401G	G3VM-41PR11
G3VM-401B/E	G3VM-81GR1	G3VM-401H	G3VM-41PR12
G3VM-401BY/EY	G3VM-81HR	G3VM-402J	G3VM-51PR
G3VM-402C/F	G3VM-201G	G3VM-601G	G3VM-61PR
G3VM-601BY/EY	G3VM-201G1		G3VM-61PR1

MOS FET Relays That Use GaAlAs LEDs

DIP	SOP	SSOP	SSOP
G3VM-21AR/DR	G3VM-61BR/ER	G3VM-21HR	G3VM-21LR10
G3VM-21BR/ER	G3VM-61BR1/ER1	G3VM-41HR	G3VM-41LR10
G3VM-41AR/DR	G3VM-101AR/DR	G3VM-61HR	G3VM-41LR11
G3VM-41BR/ER	G3VM-101BR/ER	G3VM-101HR	
G3VM-61AR/DR			

Common Precautions for All MOS FET Relays

Data on Estimated Temporal Changes in GaAs LEDs

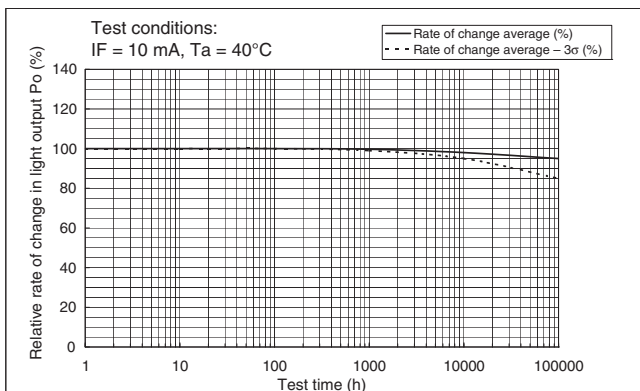
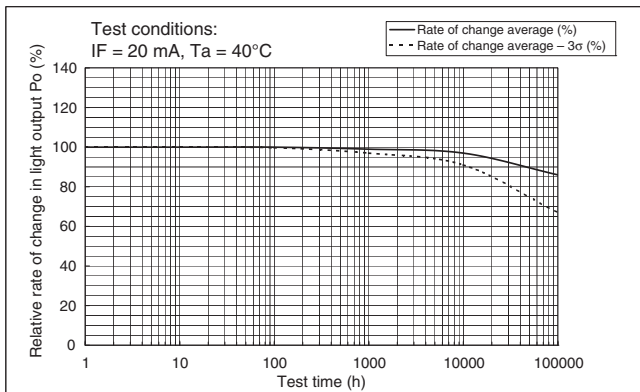
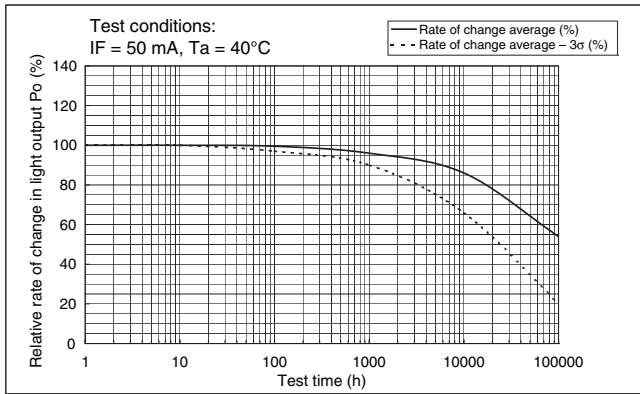

Estimated Life Data for GaAs LEDs

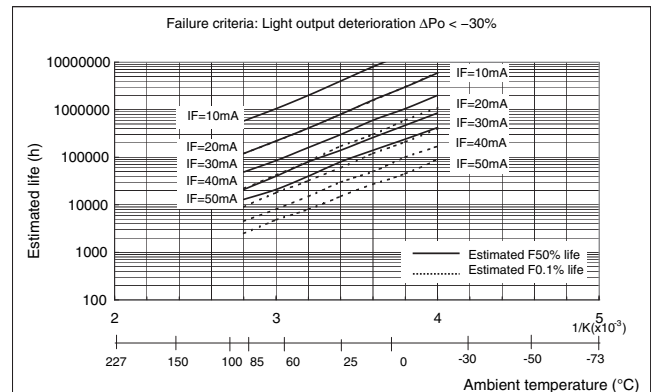
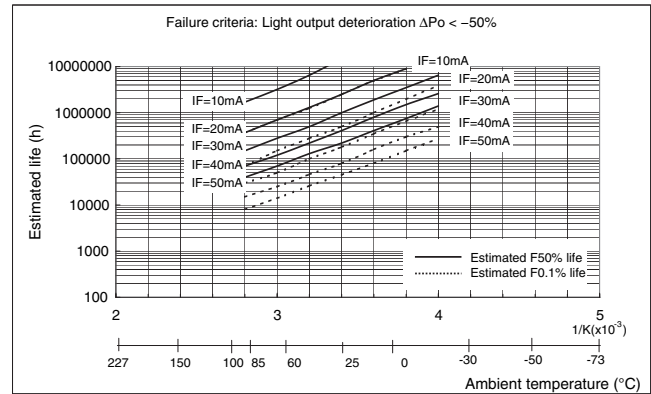

The above estimated life data is reference data that was based on LED long-term appraisal for a single lot.

Operating conditions that exceed the ratings for some models are included, but this in no way implies any warranty for operation that exceeds the ratings.

F50% Life:

For the life to a 50% cumulative failure rate, this is the time that is required for the AVG average line in the data on estimated temporal changes to reach the failure criteria.

F0.1% Life:

For the life to a 0.1% cumulative failure rate, this is the time that is required for the AVG-3σ line in the data on estimated temporal changes to reach the failure criteria.

Whether to use estimated F50% life or F0.1% life should be determined based on the reliability required in the actual equipment, however, estimated F0.1% life is normally recommended.

"Optical output deterioration Δp_o " is the amount of LED optical output deterioration compared to the initial LED output. When "Optical output deterioration failure criterion $\Delta p_o < -50\%$ ", a failure is detected when optical output has deteriorated 50% from the initial output.

Whether to use optical output deterioration $\Delta p_o < -50\%$ or $\Delta p_o < -30\%$ should be determined based on the amount of leeway to be provided in the LED forward current (IF) setting with respect to the trigger LED forward current (IF_T). However, the $\Delta p_o < -30\%$ graph is normally recommended.

Common Precautions for All MOS FET Relays

Data on Estimated Temporal Changes in GaAlAs LEDs

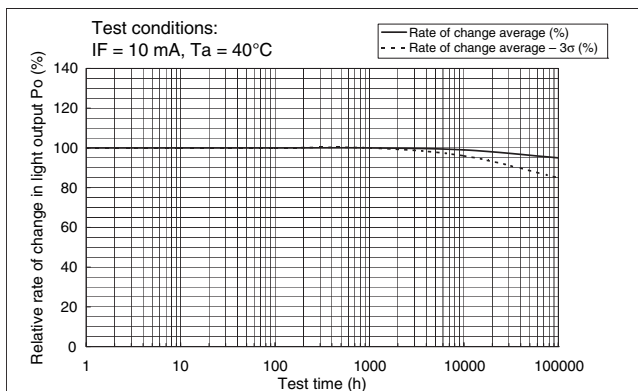
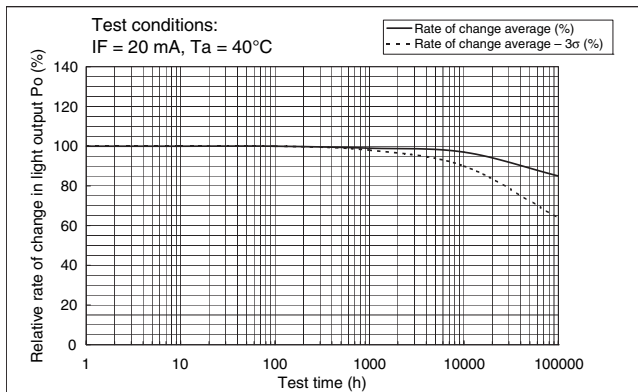
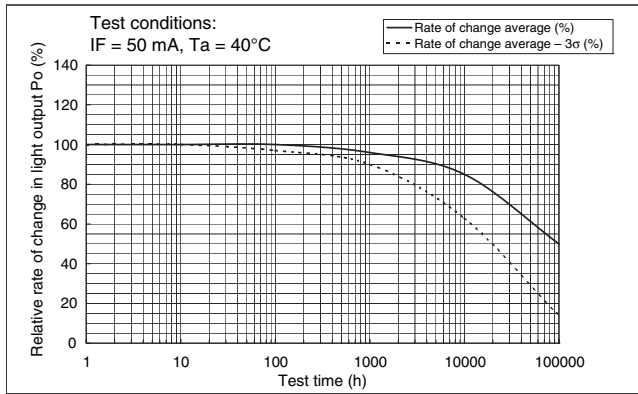

Estimated Life Data for GaAlAs LEDs

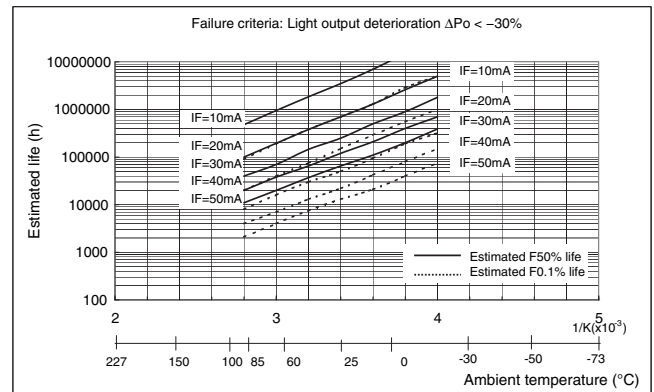
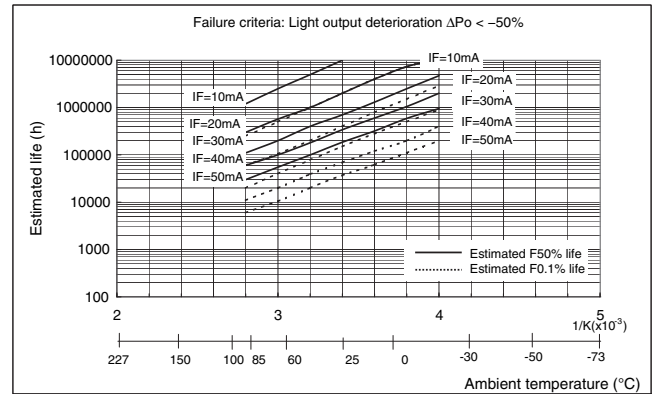

The above estimated life data is reference data that was based on LED long-term appraisal for a single lot.

Operating conditions that exceed the ratings for some models are included, but this in no way implies any warranty for operation that exceeds the ratings.

F50% Life:

For the life to a 50% cumulative failure rate, this is the time that is required for the AVG average line in the data on estimated temporal changes to reach the failure criteria.

F0.1% Life:

For the life to a 0.1% cumulative failure rate, this is the time that is required for the AVG-3σ line in the data on estimated temporal changes to reach the failure criteria.

Whether to use estimated F50% life or F0.1% life should be determined based on the reliability required in the actual equipment, however, estimated F0.1% life is normally recommended.

"Optical output deterioration Δpo " is the amount of LED optical output deterioration compared to the initial LED output. When "Optical output deterioration failure criterion $\Delta po < -50\%$ ", a failure is detected when optical output has deteriorated 50% from the initial output.

Whether to use optical output deterioration $\Delta po < -50\%$ or $\Delta po < -30\%$ should be determined based on the amount of leeway to be provided in the LED forward current (IF) setting with respect to the trigger LED forward current (IF_T). However, the $\Delta po < -30\%$ graph is normally recommended.

Common Precautions for All MOS FET Relays

●Cleaning Flux from the MOS FET Relays

- (1) Clean flux from the MOS FET Relay so that there will be no residue of reactive ions, such as sodium or chlorine. Some organic solvents will react with water to produce hydrogen chloride or other corrosive gases, which may cause deterioration of the MOS FET Relays.
- (2) When washing off the flux with water, make sure that there will be no residue of reactive ions, particularly sodium or chlorine.
- (3) During water washing, do not scrub the marks on the surface of the MOS FET Relay with a brush or your hand while there is cleaning liquid on the MOS FET Relay. The marks may come off.
- (4) Clean the flux from the MOS FET Relays with the chemical action of the solvent for submersed cleaning, shower cleaning, or steam cleaning. To minimize the effect on the MOS FET Relays, do not place the MOS FET Relay in the solvent or steam for more than 1 minute at a temperature of 50°C.
- (5) If you use ultrasonic cleaning, keep the time short. If the cleaning time is too long, the sealing characteristics of the molded resin and frame materials may deteriorate. The recommended basic conditions are given below.
Recommended Conditions for Ultrasonic Cleaning:
Frequency: 27 to 29 kHz
Ultrasonic wave output: 300 W max. (0.25 W/cm² max.)
Cleaning time: 30 s max.
Also, suspend the MOS FET Relays in the cleaning solution so that the MOS FET Relay and PCB do not come into direct contact with the ultrasonic transducer.

●Solder Mounting

Perform solder mounting under the following recommended conditions to prevent the temperature of the MOS FET Relays from rising.

<Flow Soldering>

PCB Terminals

(Set Temperature of Flow Bath)

Solder type	Preheating	Soldering	Count
(Lead solder) SnPb	150°C 60 to 120 s	260°C 10 s max.	Once only
(Lead-free solder) SnAgCu	150°C 60 to 120 s	260°C 10 s max.	Once only

Note: We recommend that you verify the suitability of solder mounting under actual conditions.

Surface-mount Terminals

If you are considering mounting a surface mount pin type by flow soldering, please consult us.

<Reflow Soldering>

Surface-mount Terminals

(Surface Temperature of Package)

Solder type	Preheating	Soldering		Count
(Lead solder) SnPb	140 to 160°C 60 to 120 s	210°C 30 s max.	Peak: 240°C max.	Up to twice

(Lead-free solder) SnAgCu recommended profile

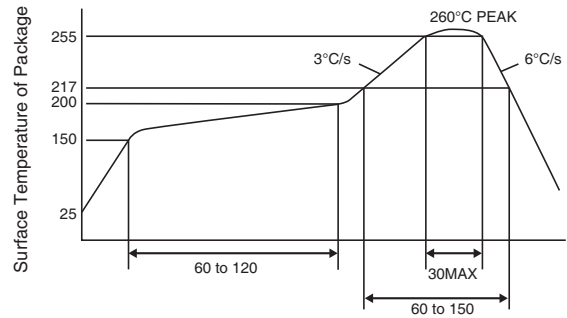

Reflow repetitions : Up to twice Time (s)

- Note: 1. We recommend that you verify the suitability of solder mounting under actual conditions.
2. When SSOP, USOP, VSON, or S-VSON products are ordered with (TR), tape package product is delivered in moisture-proof packaging. If ordered without (TR), tape-cut product is delivered in non moisture-proof packaging. Mount a tape cut product by manual soldering. Tape cut products absorb moisture because a non moisture-proof package is used. Risk of package cracking or other damage due to thermal stress if reflow soldering is performed.

Manual Soldering (Once Only)

Perform manual soldering at 350°C for 3 s or less or at 260°C for 10 s or less.

Note: Please consult us for manual soldering conditions for S-VSON products.

●Storage Conditions

- (1) Store the MOS FET Relay where they will not be subjected to water leaks or direct sunlight.
- (2) When transporting or storing the MOS FET Relays, observe all precautions on the packaging boxes.
- (3) Keep the storage location at normal temperature, normal humidity, and normal pressure. Guidelines for the temperature and humidity are 5 to 35°C and a relative humidity of 45% to 75%.
- (4) Do not store the MOS FET Relay in locations that are subject to corrosive gases, such as hydrogen sulfide gas, or to salt spray, and do not store them where there is visually apparent dust or dirt.
- (5) Store the MOS FET Relay in a location that has a relatively stable temperature. Radical changes in temperature during storage will cause condensation, which may oxidize or corrode the leads and interfere with solder wetting.
- (6) If you remove MOS FET Relays from the packages and then store them again, use storage containers that have measures to prevent static electricity.
- (7) Do not under any circumstances apply any force to the MOS FET Relays that would deform or alter them in any way.
- (8) This product is warranted for one year from the date of purchase or the date of delivery to the specified location. If the MOS FET Relays are stored for more than about one year under normal conditions, we recommend that you confirm solderability before you use the MOS FET Relays.

Common Precautions for All MOS FET Relays

●Usage Conditions

<Temperature>

The electrical characteristics of the MOS FET Relays are limited by the application temperature.

If you use them at temperatures outside of the operating temperature range, the electrical characteristics of the MOS FET Relays will not be achieved and the MOS FET Relays may deteriorate. For that reason, you must determine the temperature characteristics in advance and apply derating* to the design of the application. (*Derating reduces stress.)

Consider derating in the operating temperature conditions and apply the recommended operating temperature as a guideline.

<Humidity>

If the MOS FET Relays are used for a long period of time at high humidity, humidity will penetrate the Relays and the internal chips may deteriorate or fail. In systems with high signal source impedance, leaks in the board or leaks between the leads of the MOS FET Relays can cause malfunctions. If these are issues, consider applying humidity-resistant processing to the surfaces of the MOS FET Relays. On the other hand, at low humidity, damage from the discharge of static electricity becomes a problem. Low humidity may cause damage due to electrostatic discharge. Unless moisture proofing is implemented, use within a relative humidity range of 40 to 60%.

●Considerations when handling SSOP, USOP, VSON, and S-VSON products

<Moisture proof package, MSL3> (Other packages are MSL1)

Surface mount products may have a crack when thermal stress is applied during surface mount assembly after they absorb atmospheric moisture. Therefore, please observe the following precautions.

- (1) This moisture proof bag may be stored unopened within 12 months at the following conditions.
Temperature: 5°C to 30°C
Humidity: 90% (Max.)
- (2) After opening the moisture proof bag, the devices should be assembled within 168 hours in an environment of 5°C to 30°C / 70%RH or below.
- (3) If upon opening, the moisture indicator card shows humidity 30% or above (Color of indication changes to pink) or the expiration date has passed, the devices should be baked in taping with reel. After baking, use the baked devices within 72 hours, but perform baking only once.
Baking conditions: 60±5°C. For 64 to 72 hours.
Expiration date: 12 months from sealing date, which is imprinted on the label affixed.
- (4) Repeated baking can cause the peeling strength of the taping to change, then leads to trouble in mounting. Furthermore, prevent the devices from being destructed against static electricity for baking of it.
- (5) If the packing material of laminate would be broken the hermeticity would deteriorate. Therefore, do not throw or drop the packed devices.
- (6) Tape-cut SSOPs, USOPs, VSONs, or S-VSON are packaged without humidity resistance. Use manual soldering to mount them. (MSL not supported)

●Tape Packaging

<Tape Form and Dimensions>

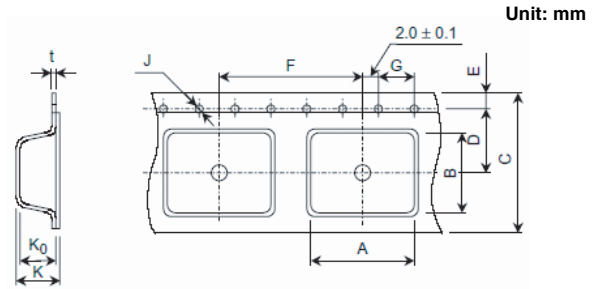

Unit: mm

Type of package		DIP4	DIP6	DIP8	Special SOP4	SOP4
Dimension symbol (See figure.)	A	10.4±0.1			4.0±0.1	4.3±0.1
	B	5.1±0.1	7.6±0.1	10.1±0.1	7.6±0.1	7.5±0.1
	C	16±0.3			12±0.3	
	D	7.5±0.1			5.5±0.1	
	E	1.75±0.1				
	F	12.0±0.1		8.0±0.1		
	G	4.0±0.1				
	J	1.5+0.1/-0				
	k	4.55±0.2			2.9±0.2	2.6±0.2
	ko	4.1±0.1			2.6±0.1	2.4±0.1
	t	0.4±0.05			0.3±0.05	

Type of package		SOP6	SOP8	SSOP4	USOP4	VSON4	S-VSON4
Dimension symbol (See figure.)	A	7.5±0.1		2.35±0.2	2.6±0.1	1.6±0.1	
	B	6.7±0.1	10.5±0.1	4.5±0.1	3.55±0.1	3.0±0.1	2.25±0.1
	C	16±0.3		12±0.3		8.0±0.3	
	D	7.5±0.1		5.5±0.1		3.5±0.1	
	E	1.75±0.1					
	F	12.0±0.1		4.0±0.1			
	G	4.0±0.1					
	J	1.5+0.1-0					
	k	2.5±0.2	2.4±0.2	2.4±0.1	2.25±0.1	-	
	ko	2.3±0.1	2.2±0.1	2.1±0.1	1.95±0.1	1.5±0.1	1.85±0.1
	t	0.3±0.05			0.3±0.1	0.2±0.05	

<Reel Form and Dimensions>

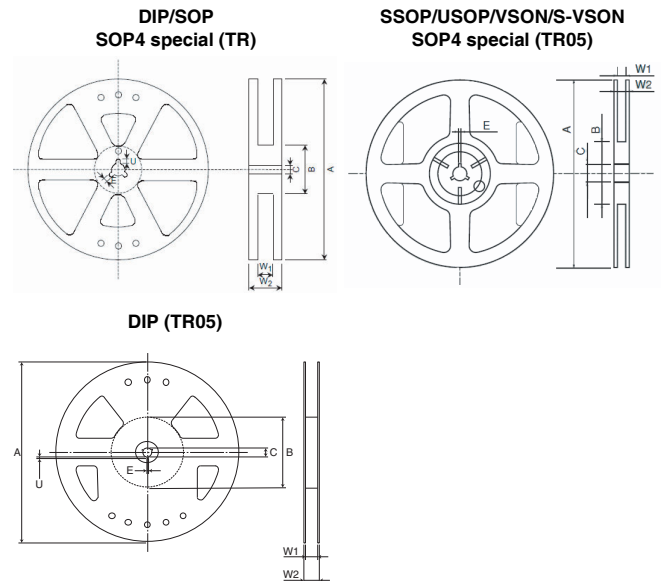

Common Precautions for All MOS FET Relays

Unit: mm

Type of package	DIP4		DIP6	DIP8	Special SOP4	SOP4	SOP6	SOP8	
Tape name	(TR05)		(TR)						
Dimension symbol (See figure.)	Dimensions	A	254±2 dia.	380±2 dia.	330±2 dia.				
		B	100±1 dia.	80±1 dia.					
		C	13±0.2 dia.	13±0.5 dia.					
		E	2.0±0.5	2.0±0.5					
		U	4.0	4.0±0.5					
		W1	17.4±1.0	17.5±0.5	13.5±0.5	17.5±0.5			
		W2	21.4±1.0	21.5±1.0	17.5±1.0	21.5±1.0			

Type of package	Special SOP4	SSOP4	USOP4	VSON4	S-VSON4		
Tape name	(TR05)						
Dimension symbol (See figure.)	Dimensions	A	180±2.0 dia.	180+0/-4 dia.	180±3 dia.		
		B	60±1.0 dia.	60 dia.	60±1 dia.		
		C	13±0.5 dia.	13 dia.	13±0.5 dia.		
		E	2.0±0.5				
		U	4.0±0.5 dia.	---	4.0±0.5		
		W1	13.5±0.5 dia.	13±0.3	9.0±0.3		
		W2	17.5±1.0 dia.	15.4±1.0	11.4±1.0		

<Taping Direction>

The orientations of the MOS FET Relays in the depressions in the carrier tapes are shown below.

(1) SOP4 Pins

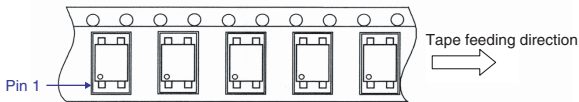

(2) SOP6, SOP8, DIP4, DIP6, or DIP8 Pins

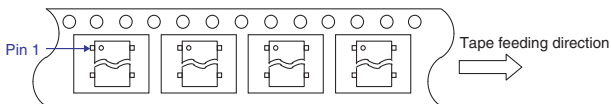

(3) SSOP4, USOP4, VSON4, S-VSON4 pin types

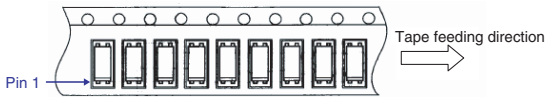

<Number of Relays Per Reel>

Type of package	DIP4	DIP6	DIP8	Special SOP4	SOP4	SOP6	SOP8
Number of Relays	TR	1,500		3,000	2,500		
	TR05	500	-		500	-	

Type of package	SSOP4	USOP4	VSON4	S-VSON4	
Number of Relays	TR	-			
	TR05	500			

●Stick packaging

<Stick shape and dimensions>

Unit: mm

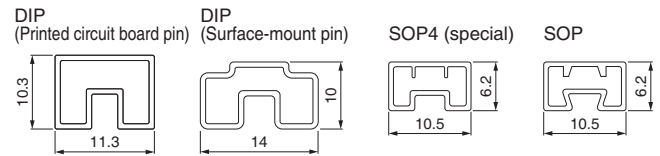

Type of package	DIP4	DIP6	DIP8	DIP4	DIP6	DIP8	Special SOP4	SOP4	SOP6	SOP8
Pin type	Printed circuit board pin			Surface-mount pin						
Number of Relays	100	50	50	100	50	50	125	100	75	50
Height (mm)	10.3			10			6.2			
Width (mm)	11.3			14			10.5			
Length (mm)	525			525			555			

- Application examples provided in this document are for reference only. In actual applications, confirm equipment functions and safety before using the product.
- Consult your OMRON representative before using the product under conditions which are not described in the manual or applying the product to nuclear control systems, railroad systems, aviation systems, vehicles, combustion systems, medical equipment, amusement machines, safety equipment, and other systems or equipment that may have a serious influence on lives and property if used improperly. Make sure that the ratings and performance characteristics of the product provide a margin of safety for the system or equipment, and be sure to provide the system or equipment with double safety mechanisms.

Note: Do not use this document to operate the Unit.