

49 CKT  
SCALE 1.5:1

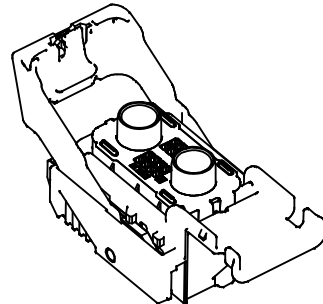

18 CKT  
SCALE 1.5:1

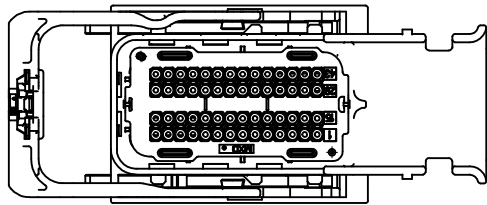
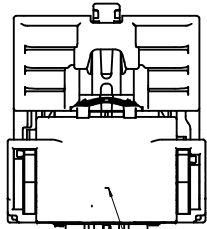

RECOMMENDED LOCATION FOR NOTE 2D

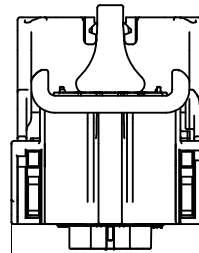
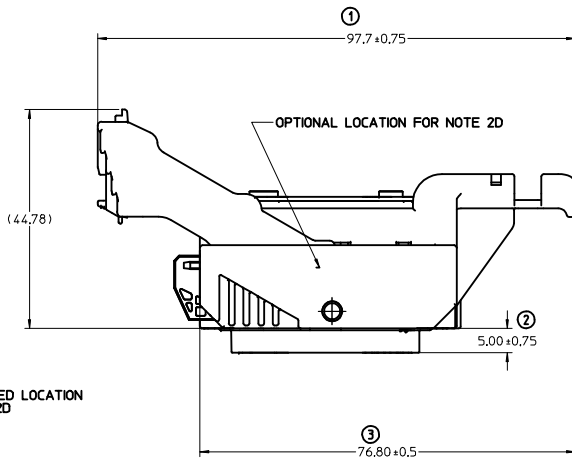

④ 40.40 ± 0.50

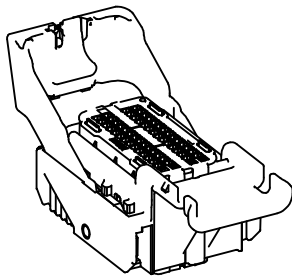

56 CKT  
SCALE 1.5:1

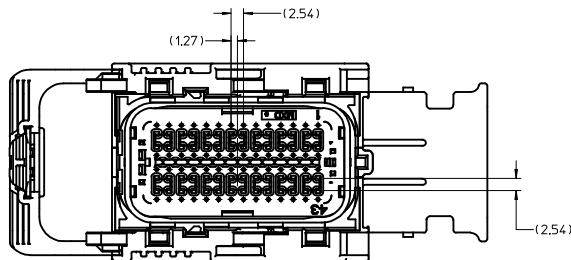

NOTES: UNLESS OTHERWISE SPECIFIED

1. MATERIAL:

- A. RESIN: SEE COMPONENT DRAWINGS
- B. COLOR: SEE TABLE
- C. MOLEX EDP #: SEE TABLE
- D. PART VOLUME: SEE COMPONENT DRAWINGS

2. DESIGN - GENERAL:

- A. THIS IS A 100% CAD GENERATED PART. THE CAD MATHEMATICAL DATA IS THE MASTER FOR THIS PART. FOR DIMENSIONAL OR ANY INFORMATION NOT SHOWN ON THIS DRAWING, ANALYZE THE CAD MODEL.
- B. TOLERANCES:
  - a. LINEAR XX ± 0.30
  - XXX ± 0.10
  - XXXX ± 0.10
  - b. ANGULAR X° ± 3.0°
- C. CORNERS SHOWN AS SHARP TO BE R 0.2 MAX.
- D. FOLLOWING PRODUCTION CODES TO BE PERMANENTLY MARKED & HUMAN READABLE TO A LETTER HEIGHT < 3mm.
  - LINE #1: MATERIAL #: XXXX-XXXX
  - LINE #2: DATE CODE: JJYY (JULIAN DAY, LAST DIGIT OF YEAR)
  - LINE #3: INSPECTION MACHINE CODE + SERIAL #: X\_XXXX
- E-1. PARTS MUST BE FREE OF DISCOLORATION, SALT RESIDUE AND OTHER IMPERFECTIONS THAT AFFECT FIT OR FUNCTION.
- E-2. SCRATCHES OR DENTS NOT TO EXCEED 0.15mm IN DEPTH.
- F. CHANGES IN DESIGN FROM PART PREVIOUSLY APPROVED REQUIRES PRIOR ENGINEERING APPROVAL. THIS INCLUDES BUT IS NOT LIMITED TO DRAFT, MATERIAL OR PROCESSING.
- G. SHALL CONFORM TO THE FOLLOWING PACKAGING SPECIFICATION: PK-31300-019

3. DESIGN - MANUFACTURING:

- A. DRAFT TO BE WITHIN TOLERANCE.
- B. ALLOWABLE FLASH 0.2 MAX HIGH X 0.13 MAX THICK.
- C. ALLOWABLE PARTING LINE MISMATCH 0.2 MAX.
- D. EJECTOR PINS MARK TO BE FLUSH TO 0.25 MAX DEPRESSED.
- E. ALLOWABLE GATE VESTIGE TO BE FLUSH TO 0.25 MAX PROTRUSION.

4. SYSTEM REQUIREMENTS:

- WHEN TESTED TO SAE/USCAR-2 REV: 3, APRIL 2001, AND GMW #3191, AUGUST 22, 2000 (DRAFT).
- A. TPA (WITHOUT TERMINALS)
  - a. INSERTION FORCE FROM PRE-SET TO LOCK: >20
  - b. REMOVAL FORCE FROM PRE-SET: >20
- B. CPA
  - a. INSERTION FORCE FROM PRE-SET TO LOCK WITH CONNECTOR UN-MATED: >60N
  - b. REMOVAL FORCE FROM PRE-SET: >30N
- C. GROMMET CAP
  - a. REMOVAL FORCE FROM HOUSING WITH ENGAGED LATCHES: >110N
- D. MATE ASSIST LEVER
  - a. INADVERTENT ACTUATION FORCE DURING SHIPPING, HANDLING OR PRE-ASSEMBLY: >190N

F38	ADDED NEW PART NO. 34576-7193
F37	ADDED NEW PART NO. 34576-7183
F36	RELEASE 18CKT FOR PV TOOL BUILD
F35	CHANGED PART NUMBER TO AVAILABLE
F34	ADDED NEW PART NO. 34576-7173
F33	ADDED NEW PART NO. 34576-7163
F32	ADDED NEW PART NO. 34576-7153
F31	REVISE 34576-7123 PIN-OUT CONFIGURATION
F30	ADDED NEW PART NO. 34576-7133
F29	ADDED NEW PART NO. 34576-7143
F28	ADDED NEW PART NO. 34576-7123
F27	ADDED NEW PART NO. 34576-7113
F26	ADDED NEW PART NO. 34576-6993
F25	ADDED NEW PART NO. 34576-6973
F24	ADDED NEW PART NO. 34576-6963
F23	ADDED NEW PART NO. 34576-6953
F22	CHANGE WIRE DRESS OPTION FROM 0 TO 9 FOR PART NO. 34576-6943
F21	ADDED NEW PART NO. 34576-6943
F20	ADDED NEW PART NO. 34576-6933
F19	ADDED 18CKT FULLY PLUGGED PIN CONFIG PART NUMBERS
F18	ADDED 18CKT KEY G AND KEY H
F17	NEW PIN CONFIGURATION
F16	NEW PIN CONFIGURATION
F15	NEW PIN CONFIGURATION
F14	NEW PIN CONFIGURATION
F13	NEW PIN CONFIGURATION
F12	NEW PIN CONFIGURATION
REV	DESCRIPTION

BALLOONS ADDED ① ② ③ ④

ENTER DESCRIPTION EDC NO: UAU2013-1350 DRAWN BY: CHYD APPR: KOSHY TJS 2013/02/26 2013/02/28	QUALITY SYMBOLS	GENERAL TOLERANCES (UNLESS SPECIFIED)	DIMENSION STYLE	SCALE	DESIGN UNITS	THIRD ANGLE PROJECTION
	▽=0	mm	MM ONLY	2:1	METRIC	☉
	▽=0	INCH	SKRAJENDRANA 2011/01/25			
	▽=0		CHECKED BY: DATE			
		APPROVED BY: DATE				
		ANGULAR ±	MATERIAL NO.	DOCUMENT NO.		
		DRAFT WHERE APPLICABLE MUST REMAIN WITHIN DIMENSIONS	SEE BOM TABLE	SD-34576-001		
			THIS DRAWING CONTAINS INFORMATION THAT IS PROPRIETARY TO MOLEX INCORPORATED AND SHOULD NOT BE USED WITHOUT WRITTEN PERMISSION			

MX123  
18/49/56 CKT  
HRNS CONN ASSY

**molex**

SD-34576-001

SHEET NO. 1 OF 15

56 CKT

WIRE DRESS OPTION 0

HOUSING ONLY, SHOWN FOR CLARITY

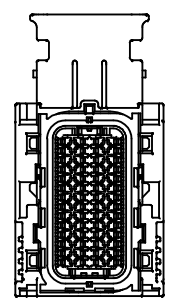
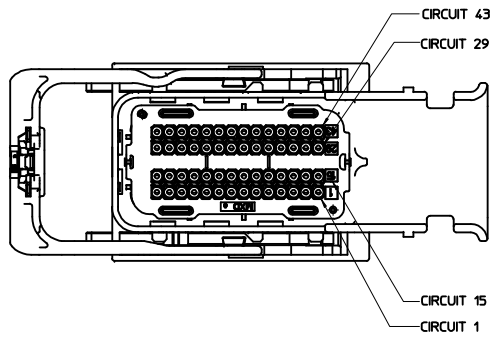

KEY G

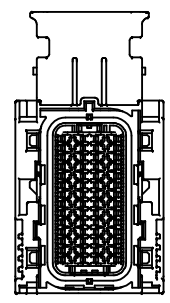

KEY H

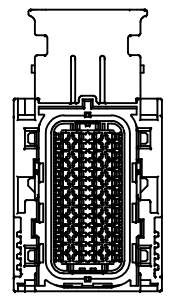

KEY J

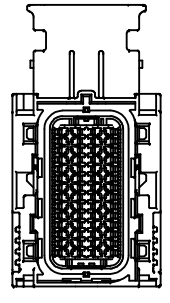

KEY K

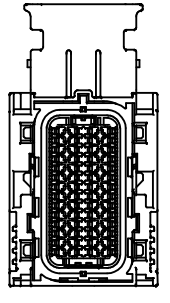

KEY L

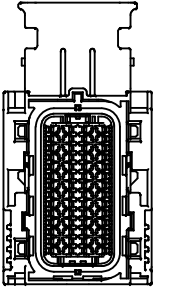

KEY M

WIRE DRESS OPTION 9

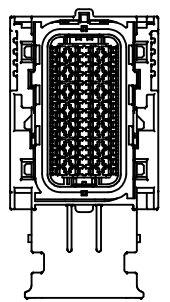
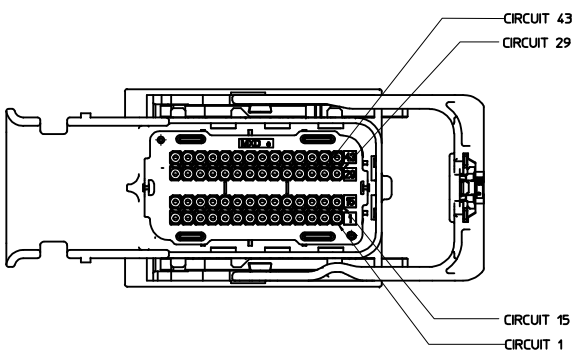

KEY G

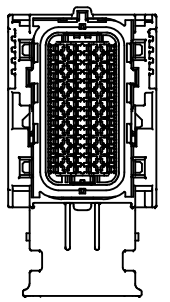

KEY H

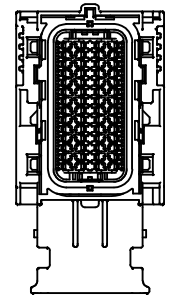

KEY J

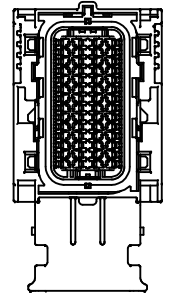

KEY K

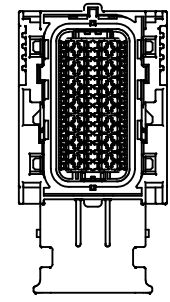

KEY L

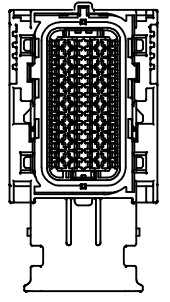

KEY M

ENTER DESCRIPTION EC NO: UAU2013-1350 DRAWN BY: TJJ CHKD: TJS APPR: IKOSHY	2013/02/26 DESCRIPTION	QUALITY SYMBOLS ▽=0 ▽=0 ▽=0	GENERAL TOLERANCES (UNLESS SPECIFIED)		DIMENSION STYLE MM ONLY	SCALE 1:1	DESIGN UNITS METRIC	THIRD ANGLE PROJECTION	
			4 PLACES   mm   INCH 3 PLACES   +   + 2 PLACES   +   + 1 PLACE   +   + 0 PLACE   +   +	DRAWN BY SKRAJENDRANA	DATE 2011/01/25	TITLE MX123 18/49/56 CKT HRNS CONN ASSY			
			ANGULAR ±---° DRAFT WHERE APPLICABLE MUST REMAIN WITHIN DIMENSIONS	APPROVED BY	DATE	molex			
			SEE BOM TABLE	MATERIAL NO. SD-34576-001	DOCUMENT NO.	SHEET NO. 2 OF 15			

49 CKT

WIRE DRESS OPTION 0

HOUSING ONLY, SHOWN FOR CLARITY

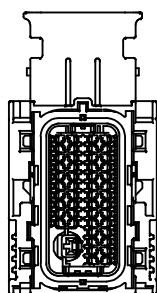
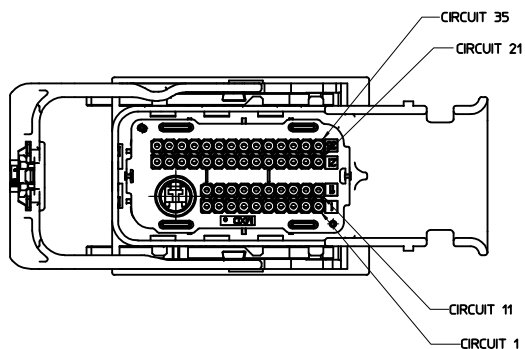

KEY A

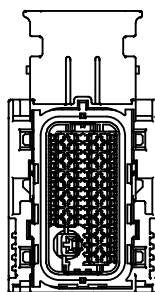

KEY B

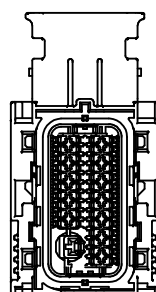

KEY C

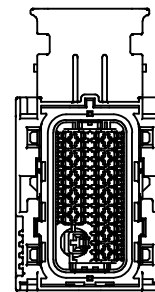

KEY D

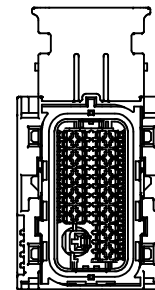

KEY E

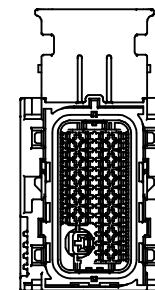

KEY F

WIRE DRESS OPTION 9

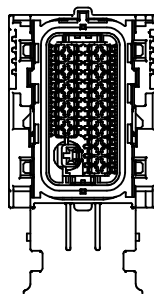
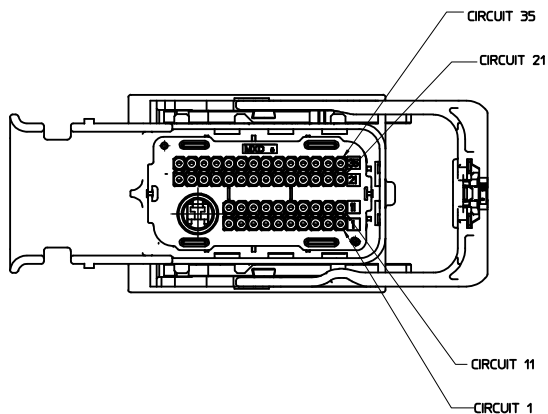

KEY A

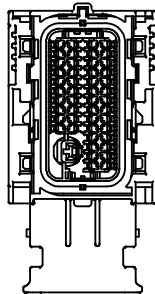

KEY B

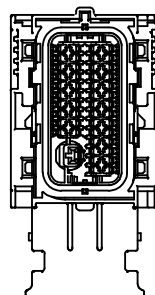

KEY C

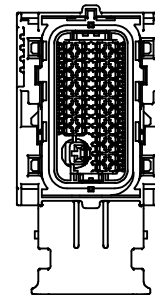

KEY D

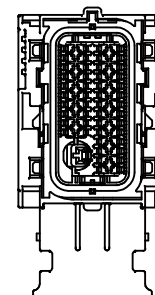

KEY E

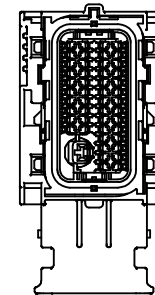

KEY F

ENTER DESCRIPTION EC NO: UAU2013-1350 DRAWN BY: DRINKATE CHKD: TJSB APPR: IKOSHY REV: 2013/02/26	QUALITY SYMBOLS	GENERAL TOLERANCES (UNLESS SPECIFIED)	DIMENSION STYLE	SCALE	DESIGN UNITS	THIRD ANGLE PROJECTION
	▽=0	mm INCH	MM ONLY	1.5:1	METRIC	
	▽=0	4 PLACES +---+---	DRAWN BY: SKRAJENDRANA	DATE: 2011/01/25	TITLE	MX123
	▽=0	3 PLACES +---+---	CHECKED BY:	DATE:	18/49/56 CKT	HRNS CONN ASSY
	2 PLACES +---+---	ANGULAR ±---°	APPROVED BY:	DATE:	<b>molex</b>	
	1 PLACE +---+---	DRAFT WHERE APPLICABLE MUST REMAIN WITHIN DIMENSIONS	MATERIAL NO.	DOCUMENT NO.	SD-34576-001	SHEET NO. 3 OF 45
	0 PLACE +---+---		SEE BOM TABLE	THIS DRAWING CONTAINS INFORMATION THAT IS PROPRIETARY TO MOLEX INCORPORATED AND SHOULD NOT BE USED WITHOUT WRITTEN PERMISSION		

18 CKT

WIRE DRESS OPTION 0

HOUSING ONLY, SHOWN FOR CLARITY

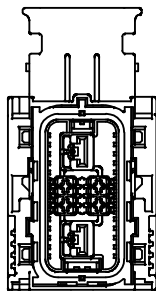
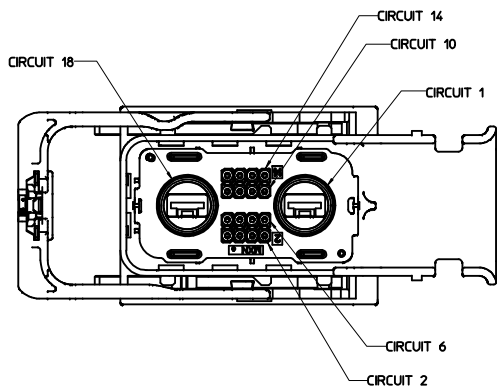

KEY G

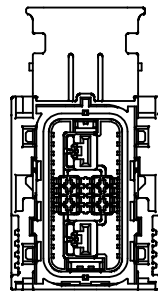

KEY H

WIRE DRESS OPTION 9

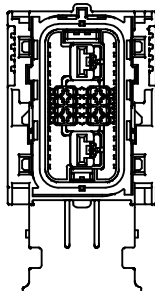
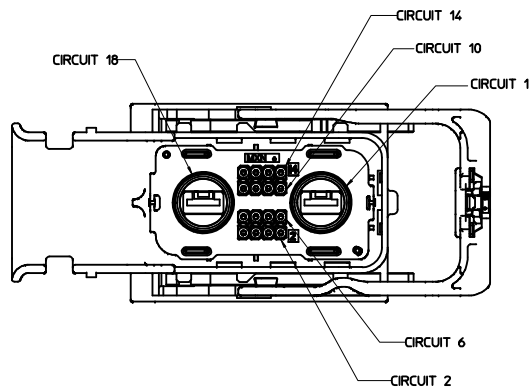

KEY G

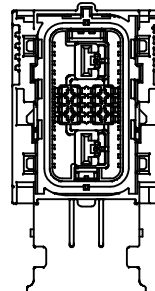

KEY H

ENTER DESCRIPTION EC NO: UAU2013-1350 DRAWN BY: 2013/02/26 CHKD: APPR: IKOSHY T38 REV	QUALITY SYMBOLS	GENERAL TOLERANCES (UNLESS SPECIFIED)	DIMENSION STYLE	SCALE	DESIGN UNITS	THIRD ANGLE PROJECTION	
	∇=0 ∇=0 ∇=0	4 PLACES ±---+--- 3 PLACES ±---+--- 2 PLACES ±---+--- 1 PLACE ±---+--- 0 PLACE ±---+---	mm INCH ANGULAR ±---° DRAFT WHERE APPLICABLE MUST REMAIN WITHIN DIMENSIONS	MM ONLY DRAWN BY: SKRAJENDRANA 2011/01/25 CHECKED BY: DATE APPROVED BY: DATE	2:1	METRIC	MX123 18/49/56 CKT HRNS CONN ASSY <b>molex</b>
				MATERIAL NO.	DOCUMENT NO.	SHEET NO.	
				SEE BOM TABLE	SD-34576-001	4 OF 15	

THIS DRAWING CONTAINS INFORMATION THAT IS PROPRIETARY TO MOLEX INCORPORATED AND SHOULD NOT BE USED WITHOUT WRITTEN PERMISSION

20 19 18 17 16 15 14 13 12 11 10 9 8 7 6 5 4 3 2 1

CKT SIZE	STATUS	MATERIAL #	PART / MATERIAL REVISION	WIRE DRESS OPTION	KEY OPTION	COLOR (TPA)	NUMBERS INDICATE CAVITIES OPEN FOR CIRCUITS
49 CKT	ACTIVE	34576-0103	F	0	A	BLACK	
	NOT TOOLED	34576-0203	F	0	B	ST GRY	48 47 46 45 44 43 42 41 40 39 38 37 36 35
	NOT TOOLED	34576-0303	F	0	C	BLUE	34 33 32 31 30 29 28 27 26 25 24 23 22 21
	NOT TOOLED	34576-0403	F	0	D	BROWN	49 20 19 18 17 16 15 14 13 12 11
	NOT TOOLED	34576-0503	F	0	E	GREEN	10 9 8 7 6 5 4 3 2 1
	NOT TOOLED	34576-0603	F	0	F	NATURAL	
56 CKT	AVAILABLE	34576-0703	F	0	G	BLUE	
	ACTIVE	34576-0803	F	0	H	ST GRY	56 55 54 53 52 51 50 49 48 47 46 45 44 43
	ACTIVE	34576-0903	F	0	J	BLACK	42 41 40 39 38 37 36 35 34 33 32 31 30 29
	ACTIVE	34576-1003	F	0	K	BROWN	28 27 26 25 24 23 22 21 20 19 18 17 16 15
	ACTIVE	34576-1103	F	0	L	GREEN	14 13 12 11 10 9 8 7 6 5 4 3 2 1
	ACTIVE	34576-1203	F	0	M	NATURAL	
49 CKT	ACTIVE	34576-1303	F	9	A	BLACK	
	NOT TOOLED	34576-1403	F	9	B	ST GRY	48 47 46 45 44 43 42 41 40 39 38 37 36 35
	NOT TOOLED	34576-1503	F	9	C	BLUE	34 33 32 31 30 29 28 27 26 25 24 23 22 21
	NOT TOOLED	34576-1603	F	9	D	BROWN	49 20 19 18 17 16 15 14 13 12 11
	NOT TOOLED	34576-1703	F	9	E	GREEN	10 9 8 7 6 5 4 3 2 1
	NOT TOOLED	34576-1803	F	9	F	NATURAL	
56 CKT	AVAILABLE	34576-1903	F	9	G	BLUE	
	ACTIVE	34576-2003	F	9	H	ST GRY	56 55 54 53 52 51 50 49 48 47 46 45 44 43
	ACTIVE	34576-2103	F	9	J	BLACK	42 41 40 39 38 37 36 35 34 33 32 31 30 29
	ACTIVE	34576-2203	F	9	K	BROWN	28 27 26 25 24 23 22 21 20 19 18 17 16 15
	ACTIVE	34576-2303	F	9	L	GREEN	14 13 12 11 10 9 8 7 6 5 4 3 2 1
18 CKT	PV TOOL REL.	34851-0007	A	0	G	BLUE	17 16 15 14 13 12 11 10 9 8 7 6 5 4 3 2
	PV TOOL REL.	34851-0008	A	0	H	ST GRY	18 17 16 15 14 13 12 11 10 9 8 7 6 5 4 3 2
18 CKT	PV TOOL REL.	34851-0019	A	9	G	BLUE	17 16 15 14 13 12 11 10 9 8 7 6 5 4 3 2
	PV TOOL REL.	34851-0020	A	9	H	ST GRY	18 17 16 15 14 13 12 11 10 9 8 7 6 5 4 3 2
	AVAILABLE	34576-2503	F	0	G	BLUE	56 55 54 53 49 48 47 44 40 37 36 35 34 33 20 19 18 2
	AVAILABLE	34576-2603	F	0	G	BLUE	56 55 54 53 49 48 47 44 40 37 36 35 34 33 20 19 18
	AVAILABLE	34576-2703	F	0	G	BLUE	

SEE NEXT PAGE FOR ADDITIONAL NUMBERS

<b>ENTER DESCRIPTION</b> EC NO: UAU2013-1350 DRAWN BY: TJJ CHKD: TJB APPR: IKOSHY 2013/02/26 2013/02/28	QUALITY SYMBOLS	GENERAL TOLERANCES (UNLESS SPECIFIED)	DIMENSION STYLE	SCALE	DESIGN UNITS	THIRD ANGLE PROJECTION
	▽=0	4 PLACES ±---+ INCH	MM ONLY	2:1	METRIC	
	▽=0	3 PLACES ±---+ INCH				
	▽=0	2 PLACES ±---+ INCH				
	1 PLACE ±---+ INCH					
	0 PLACE ±---+ INCH					
	ANGULAR ±---°					
	DRAFT WHERE APPLICABLE MUST REMAIN WITHIN DIMENSIONS					
			MATERIAL NO.	DOCUMENT NO.		
			SEE BOM TABLE	SD-34576-001		
						SHEET NO. 5 OF 15

MX123  
18/49/56 CKT  
HRNS CONN ASSY  
**molex**

19 18 17 16 15 14 13 12 11 10 9 8 7 6 5 4 3 2 1

STATUS	GM PART #	MATERIAL #	PART/MATERIAL REVISION	WIRE DRESS OPTION	KEY OPTION	COLOR (TPA)	NUMBERS INDICATE CAVITIES OPEN FOR CIRCUITS																																												
AVAILABLE	NOT APPLICABLE	34576-2803	F	0	G	BLUE	<table border="1"> <tr><td>55</td><td>54</td><td>53</td><td>51</td><td>49</td><td>48</td><td>47</td><td>44</td></tr> <tr><td>40</td><td></td><td></td><td>37</td><td>36</td><td>35</td><td>34</td><td>33</td></tr> <tr><td>26</td><td></td><td></td><td></td><td></td><td></td><td>20</td><td>19 18</td></tr> <tr><td>13</td><td>12</td><td></td><td>9</td><td>7</td><td></td><td></td><td></td></tr> </table>	55	54	53	51	49	48	47	44	40			37	36	35	34	33	26						20	19 18	13	12		9	7															
55	54	53	51	49	48	47	44																																												
40			37	36	35	34	33																																												
26						20	19 18																																												
13	12		9	7																																															
AVAILABLE	NOT APPLICABLE	34576-2903	F	0	G	BLUE	<table border="1"> <tr><td>56</td><td>55</td><td>53</td><td></td><td>49</td><td>48</td><td>47</td><td>46</td><td>45</td><td>44</td></tr> <tr><td>40</td><td>39</td><td></td><td>37</td><td>36</td><td>35</td><td>34</td><td>33</td><td></td><td>30</td></tr> <tr><td></td><td>25</td><td></td><td></td><td></td><td></td><td>20</td><td>19</td><td>18</td><td></td></tr> <tr><td>13</td><td>12</td><td></td><td>9</td><td>7</td><td></td><td></td><td></td><td></td><td></td></tr> </table>	56	55	53		49	48	47	46	45	44	40	39		37	36	35	34	33		30		25					20	19	18		13	12		9	7									
56	55	53		49	48	47	46	45	44																																										
40	39		37	36	35	34	33		30																																										
	25					20	19	18																																											
13	12		9	7																																															
AVAILABLE	NOT APPLICABLE	34576-3003	F	0	G	BLUE	<table border="1"> <tr><td>56</td><td>55</td><td>54</td><td>53</td><td></td><td>49</td><td>48</td><td>47</td><td></td><td>44</td></tr> <tr><td></td><td>40</td><td></td><td></td><td>37</td><td>36</td><td>35</td><td>34</td><td>33</td><td>29</td></tr> <tr><td></td><td></td><td></td><td></td><td></td><td></td><td></td><td>20</td><td>19</td><td>18</td></tr> <tr><td>13</td><td>12</td><td></td><td>9</td><td>7</td><td>6</td><td></td><td></td><td></td><td>2</td></tr> </table>	56	55	54	53		49	48	47		44		40			37	36	35	34	33	29								20	19	18	13	12		9	7	6				2				
56	55	54	53		49	48	47		44																																										
	40			37	36	35	34	33	29																																										
							20	19	18																																										
13	12		9	7	6				2																																										
AVAILABLE	NOT APPLICABLE	34576-3103	F	0	G	BLUE	<table border="1"> <tr><td>56</td><td>55</td><td>54</td><td>53</td><td></td><td>49</td><td>48</td><td>47</td><td>46</td><td>45</td><td>44</td></tr> <tr><td></td><td>40</td><td>39</td><td></td><td>37</td><td>36</td><td>35</td><td>34</td><td>33</td><td></td><td></td></tr> <tr><td></td><td></td><td></td><td></td><td></td><td></td><td></td><td>20</td><td>19</td><td>18</td><td></td></tr> <tr><td>13</td><td>12</td><td></td><td>9</td><td>7</td><td></td><td></td><td></td><td></td><td></td><td></td></tr> </table>	56	55	54	53		49	48	47	46	45	44		40	39		37	36	35	34	33										20	19	18		13	12		9	7						
56	55	54	53		49	48	47	46	45	44																																									
	40	39		37	36	35	34	33																																											
							20	19	18																																										
13	12		9	7																																															
AVAILABLE	NOT APPLICABLE	34576-3203	F	0	G	BLUE	<table border="1"> <tr><td>55</td><td>54</td><td>53</td><td></td><td>49</td><td>48</td><td>47</td><td>46</td><td>44</td><td></td></tr> <tr><td></td><td>40</td><td></td><td></td><td>37</td><td>36</td><td>35</td><td>34</td><td>33</td><td>32</td><td>31</td></tr> <tr><td></td><td>26</td><td></td><td></td><td></td><td></td><td></td><td>20</td><td>19</td><td>18</td><td></td></tr> <tr><td>13</td><td>12</td><td></td><td>9</td><td>7</td><td></td><td></td><td></td><td></td><td></td><td></td></tr> </table>	55	54	53		49	48	47	46	44			40			37	36	35	34	33	32	31		26						20	19	18		13	12		9	7							
55	54	53		49	48	47	46	44																																											
	40			37	36	35	34	33	32	31																																									
	26						20	19	18																																										
13	12		9	7																																															
AVAILABLE	NOT APPLICABLE	34576-3303	F	0	G	BLUE	<table border="1"> <tr><td>56</td><td>55</td><td>54</td><td></td><td>49</td><td>48</td><td>47</td><td></td><td>44</td><td></td></tr> <tr><td></td><td>40</td><td></td><td></td><td>37</td><td>36</td><td>35</td><td>34</td><td>33</td><td></td><td></td></tr> <tr><td></td><td></td><td></td><td></td><td></td><td></td><td></td><td>20</td><td>19</td><td>18</td><td></td></tr> <tr><td>13</td><td>12</td><td></td><td>9</td><td>7</td><td>6</td><td></td><td></td><td></td><td></td><td></td></tr> </table>	56	55	54		49	48	47		44			40			37	36	35	34	33										20	19	18		13	12		9	7	6						
56	55	54		49	48	47		44																																											
	40			37	36	35	34	33																																											
							20	19	18																																										
13	12		9	7	6																																														
AVAILABLE	NOT APPLICABLE	34576-3403	F	0	G	BLUE	<table border="1"> <tr><td>55</td><td>54</td><td>53</td><td></td><td>49</td><td>48</td><td>47</td><td></td><td>44</td><td></td></tr> <tr><td></td><td>40</td><td>39</td><td></td><td>37</td><td>36</td><td>35</td><td>34</td><td>33</td><td></td><td></td></tr> <tr><td></td><td>26</td><td></td><td></td><td></td><td></td><td></td><td>20</td><td>19</td><td>18</td><td></td></tr> <tr><td>13</td><td>12</td><td></td><td>9</td><td>7</td><td></td><td></td><td></td><td></td><td></td><td></td></tr> </table>	55	54	53		49	48	47		44			40	39		37	36	35	34	33				26						20	19	18		13	12		9	7							
55	54	53		49	48	47		44																																											
	40	39		37	36	35	34	33																																											
	26						20	19	18																																										
13	12		9	7																																															
AVAILABLE	NOT APPLICABLE	34576-3503	F	0	G	BLUE	<table border="1"> <tr><td>56</td><td>55</td><td>53</td><td></td><td>49</td><td>48</td><td>47</td><td></td><td>44</td><td></td></tr> <tr><td></td><td>40</td><td></td><td></td><td>37</td><td>36</td><td>35</td><td>34</td><td>33</td><td></td><td></td></tr> <tr><td></td><td></td><td></td><td></td><td></td><td></td><td></td><td>20</td><td>19</td><td>18</td><td></td></tr> <tr><td>13</td><td>12</td><td></td><td>9</td><td>7</td><td>6</td><td></td><td></td><td></td><td></td><td>2</td></tr> </table>	56	55	53		49	48	47		44			40			37	36	35	34	33										20	19	18		13	12		9	7	6					2	
56	55	53		49	48	47		44																																											
	40			37	36	35	34	33																																											
							20	19	18																																										
13	12		9	7	6					2																																									

SEE NEXT PAGE FOR ADDITIONAL NUMBERS

<b>ENTER DESCRIPTION</b> EC NO: UAU2013-1350 DRAWN BY: T38 CHKD: APPR: VKOSHY 2013/02/26 2013/02/28	QUALITY SYMBOLS ▽=0 ▽=0 ▽=0	GENERAL TOLERANCES (UNLESS SPECIFIED) mm INCH 4 PLACES ± --- ± --- 3 PLACES ± --- ± --- 2 PLACES ± --- ± --- 1 PLACE ± --- ± --- 0 PLACE ± --- ± ---	DIMENSION STYLE <b>MM ONLY</b>	SCALE <b>1:1</b>	DESIGN UNITS <b>METRIC</b>	THIRD ANGLE PROJECTION
	DRAWN BY: SKRAJENDRANA 2011/01/25 CHECKED BY: DATE		MATERIAL NO.		DOCUMENT NO.	
	APPROVED BY: DATE		SEE BOM TABLE		SD-34576-001	
	ANGULAR ± --- ° DRAFT WHERE APPLICABLE MUST REMAIN WITHIN DIMENSIONS		SHEET NO. 6 OF 45		TITLE MX123 18/49/56 CKT HRNS CONN ASSY <b>molex</b>	

STATUS	GM PART #	MATERIAL #	PART/MATERIAL REVISION	WIRE DRESS OPTION	KEY OPTION	COLOR (TPA)	NUMBERS INDICATE CAVITIES OPEN FOR CIRCUITS																																								
AVAILABLE	NOT APPLICABLE	34576-3603	F	0	G	BLUE	<table border="1"> <tr><td>55</td><td>54</td><td>53</td><td></td><td></td><td>49</td><td>48</td><td>47</td><td></td><td>44</td></tr> <tr><td>40</td><td></td><td></td><td>37</td><td>36</td><td>35</td><td>34</td><td>33</td><td></td><td></td></tr> <tr><td></td><td>26</td><td></td><td></td><td></td><td></td><td>20</td><td>19</td><td>18</td><td></td></tr> <tr><td>13</td><td>12</td><td></td><td>9</td><td>7</td><td></td><td></td><td></td><td></td><td></td></tr> </table>	55	54	53			49	48	47		44	40			37	36	35	34	33				26					20	19	18		13	12		9	7					
55	54	53			49	48	47		44																																						
40			37	36	35	34	33																																								
	26					20	19	18																																							
13	12		9	7																																											
AVAILABLE	NOT APPLICABLE	34576-3703	F	0	G	BLUE	<table border="1"> <tr><td>56</td><td>55</td><td>54</td><td>53</td><td>51</td><td>49</td><td>48</td><td>47</td><td></td><td>44</td></tr> <tr><td></td><td>40</td><td></td><td></td><td>37</td><td>36</td><td>35</td><td>34</td><td>33</td><td>29</td></tr> <tr><td></td><td></td><td></td><td></td><td></td><td></td><td>20</td><td>19</td><td>18</td><td>16</td></tr> <tr><td>13</td><td>12</td><td></td><td>9</td><td>7</td><td>6</td><td></td><td></td><td></td><td>2</td></tr> </table>	56	55	54	53	51	49	48	47		44		40			37	36	35	34	33	29							20	19	18	16	13	12		9	7	6				2
56	55	54	53	51	49	48	47		44																																						
	40			37	36	35	34	33	29																																						
						20	19	18	16																																						
13	12		9	7	6				2																																						
AVAILABLE	NOT APPLICABLE	34576-3803	F	0	G	BLUE	<table border="1"> <tr><td>56</td><td>54</td><td>53</td><td></td><td></td><td>49</td><td>47</td><td>46</td><td>44</td><td></td></tr> <tr><td></td><td>40</td><td>39</td><td>37</td><td>36</td><td>35</td><td>33</td><td>32</td><td>31</td><td>29</td></tr> <tr><td></td><td></td><td>25</td><td></td><td></td><td></td><td>20</td><td>19</td><td>18</td><td>15</td></tr> <tr><td>13</td><td>12</td><td></td><td>9</td><td>7</td><td></td><td></td><td></td><td></td><td>2</td></tr> </table>	56	54	53			49	47	46	44			40	39	37	36	35	33	32	31	29			25				20	19	18	15	13	12		9	7					2
56	54	53			49	47	46	44																																							
	40	39	37	36	35	33	32	31	29																																						
		25				20	19	18	15																																						
13	12		9	7					2																																						
AVAILABLE	NOT APPLICABLE	34576-3903	F	0	G	BLUE	<table border="1"> <tr><td>56</td><td>54</td><td>53</td><td></td><td></td><td>49</td><td>47</td><td></td><td>44</td><td></td></tr> <tr><td></td><td>40</td><td>39</td><td>37</td><td>36</td><td>35</td><td>33</td><td></td><td></td><td>29</td></tr> <tr><td></td><td></td><td>25</td><td></td><td></td><td></td><td>20</td><td>19</td><td>18</td><td>15</td></tr> <tr><td>13</td><td>12</td><td></td><td>9</td><td>7</td><td></td><td></td><td></td><td></td><td></td></tr> </table>	56	54	53			49	47		44			40	39	37	36	35	33			29			25				20	19	18	15	13	12		9	7					
56	54	53			49	47		44																																							
	40	39	37	36	35	33			29																																						
		25				20	19	18	15																																						
13	12		9	7																																											
AVAILABLE	NOT APPLICABLE	34576-4003	F	0	G	BLUE	<table border="1"> <tr><td>56</td><td>55</td><td>54</td><td>53</td><td></td><td>49</td><td>48</td><td>47</td><td>45</td><td>44</td></tr> <tr><td></td><td>40</td><td>39</td><td>37</td><td>36</td><td>35</td><td>34</td><td>33</td><td></td><td>29</td></tr> <tr><td></td><td></td><td>25</td><td></td><td></td><td></td><td>20</td><td>19</td><td>18</td><td>16</td></tr> <tr><td>13</td><td>12</td><td></td><td>9</td><td>7</td><td>6</td><td></td><td></td><td></td><td>1</td></tr> </table>	56	55	54	53		49	48	47	45	44		40	39	37	36	35	34	33		29			25				20	19	18	16	13	12		9	7	6				1
56	55	54	53		49	48	47	45	44																																						
	40	39	37	36	35	34	33		29																																						
		25				20	19	18	16																																						
13	12		9	7	6				1																																						
AVAILABLE	NOT APPLICABLE	34576-4103	F	0	G	BLUE	<table border="1"> <tr><td>56</td><td>55</td><td>54</td><td>53</td><td></td><td>49</td><td>48</td><td>47</td><td>46</td><td>44</td></tr> <tr><td></td><td>40</td><td>39</td><td>38</td><td>37</td><td>36</td><td>35</td><td>34</td><td>33</td><td>32</td></tr> <tr><td></td><td></td><td>25</td><td></td><td></td><td></td><td>20</td><td>19</td><td>18</td><td>16</td></tr> <tr><td>13</td><td>12</td><td></td><td>9</td><td>7</td><td></td><td></td><td></td><td></td><td></td></tr> </table>	56	55	54	53		49	48	47	46	44		40	39	38	37	36	35	34	33	32			25				20	19	18	16	13	12		9	7					
56	55	54	53		49	48	47	46	44																																						
	40	39	38	37	36	35	34	33	32																																						
		25				20	19	18	16																																						
13	12		9	7																																											
AVAILABLE	NOT APPLICABLE	34576-4203	F	0	G	BLUE	<table border="1"> <tr><td>56</td><td>55</td><td>54</td><td>53</td><td></td><td>49</td><td>48</td><td>47</td><td>45</td><td>44</td></tr> <tr><td></td><td>40</td><td>39</td><td>37</td><td>36</td><td>35</td><td>34</td><td>33</td><td></td><td></td></tr> <tr><td></td><td></td><td></td><td></td><td></td><td></td><td>20</td><td>19</td><td>18</td><td></td></tr> <tr><td>13</td><td>12</td><td></td><td>9</td><td>7</td><td></td><td></td><td></td><td></td><td></td></tr> </table>	56	55	54	53		49	48	47	45	44		40	39	37	36	35	34	33									20	19	18		13	12		9	7					
56	55	54	53		49	48	47	45	44																																						
	40	39	37	36	35	34	33																																								
						20	19	18																																							
13	12		9	7																																											
AVAILABLE	NOT APPLICABLE	34576-4303	F	0	G	BLUE	<table border="1"> <tr><td>56</td><td>55</td><td>54</td><td>53</td><td>51</td><td>49</td><td>48</td><td>47</td><td>45</td><td>44</td></tr> <tr><td>41</td><td>40</td><td>38</td><td>37</td><td>36</td><td>35</td><td>34</td><td>33</td><td></td><td>30</td></tr> <tr><td></td><td>26</td><td>25</td><td>24</td><td>22</td><td>21</td><td>20</td><td>19</td><td>17</td><td></td></tr> <tr><td>13</td><td>12</td><td></td><td>9</td><td>7</td><td></td><td></td><td>4</td><td>3</td><td>1</td></tr> </table>	56	55	54	53	51	49	48	47	45	44	41	40	38	37	36	35	34	33		30		26	25	24	22	21	20	19	17		13	12		9	7			4	3	1
56	55	54	53	51	49	48	47	45	44																																						
41	40	38	37	36	35	34	33		30																																						
	26	25	24	22	21	20	19	17																																							
13	12		9	7			4	3	1																																						

SEE NEXT PAGE FOR ADDITIONAL NUMBERS

<b>ENTER DESCRIPTION</b> EC NO: UAU2013-1350 DRAWN BY: CHYK APPR: IKOSHY 2013/02/26 2013/02/28 FJ38	QUALITY SYMBOLS ▽=0 ▽=0 ▽=0	GENERAL TOLERANCES (UNLESS SPECIFIED) mm INCH 4 PLACES ±--- ±--- 3 PLACES ±--- ±--- 2 PLACES ±--- ±--- 1 PLACE ±--- ±--- 0 PLACE ±--- ±---	DIMENSION STYLE <b>MM ONLY</b>	SCALE <b>1:1</b>	DESIGN UNITS <b>METRIC</b>	THIRD ANGLE PROJECTION
	DRAWN BY: SKRAJENDRANA 2011/01/25 CHECKED BY: DATE		MATERIAL NO.		DOCUMENT NO.	
	APPROVED BY: DATE		ANGULAR ±---°		SEE BOM TABLE	
	DRAFT WHERE APPLICABLE MUST REMAIN WITHIN DIMENSIONS		SIZE D		THIS DRAWING CONTAINS INFORMATION THAT IS PROPRIETARY TO MOLEX INCORPORATED AND SHOULD NOT BE USED WITHOUT WRITTEN PERMISSION	

MX123  
18/49/56 CKT  
HRNS CONN ASSY

**molex**

SD-34576-001

SHEET NO. 7 OF 15

34576

STATUS	GM PART #	MATERIAL #	PART/MATERIAL REVISION	WIRE DRESS OPTION	KEY OPTION	COLOR (TPA)	NUMBERS INDICATE CAVITIES OPEN FOR CIRCUITS																																																
AVAILABLE	NOT APPLICABLE	34576-4403	F	0	G	BLUE	<table border="1"> <tr><td>56</td><td>55</td><td>54</td><td>53</td><td></td><td></td><td>49</td><td>48</td><td>47</td><td>46</td><td>44</td></tr> <tr><td></td><td></td><td>40</td><td>39</td><td>37</td><td>36</td><td>35</td><td>34</td><td>33</td><td>32</td><td>31</td><td>29</td></tr> <tr><td></td><td></td><td></td><td>25</td><td></td><td></td><td></td><td>20</td><td>19</td><td>18</td><td>16</td><td></td></tr> <tr><td></td><td></td><td>12</td><td></td><td></td><td>9</td><td>7</td><td></td><td></td><td></td><td></td><td></td></tr> </table>	56	55	54	53			49	48	47	46	44			40	39	37	36	35	34	33	32	31	29				25				20	19	18	16				12			9	7						
56	55	54	53			49	48	47	46	44																																													
		40	39	37	36	35	34	33	32	31	29																																												
			25				20	19	18	16																																													
		12			9	7																																																	
AVAILABLE	NOT APPLICABLE	34576-4503	F	0	G	BLUE	<table border="1"> <tr><td>56</td><td>55</td><td>54</td><td>53</td><td></td><td></td><td>49</td><td>48</td><td>47</td><td>46</td><td>44</td></tr> <tr><td></td><td></td><td>40</td><td>39</td><td>37</td><td>36</td><td>35</td><td>34</td><td>33</td><td>32</td><td>31</td><td>30</td></tr> <tr><td></td><td></td><td></td><td>25</td><td>24</td><td></td><td>22</td><td>21</td><td>20</td><td>19</td><td>18</td><td>16</td></tr> <tr><td></td><td></td><td>13</td><td>12</td><td></td><td>9</td><td>7</td><td></td><td></td><td>4</td><td>2</td><td>1</td></tr> </table>	56	55	54	53			49	48	47	46	44			40	39	37	36	35	34	33	32	31	30				25	24		22	21	20	19	18	16			13	12		9	7			4	2	1	
56	55	54	53			49	48	47	46	44																																													
		40	39	37	36	35	34	33	32	31	30																																												
			25	24		22	21	20	19	18	16																																												
		13	12		9	7			4	2	1																																												
AVAILABLE	NOT APPLICABLE	34576-4603	F	0	G	BLUE	<table border="1"> <tr><td>56</td><td>55</td><td>54</td><td>53</td><td></td><td></td><td>49</td><td>48</td><td>47</td><td>46</td><td>44</td></tr> <tr><td></td><td></td><td>40</td><td>39</td><td>37</td><td>36</td><td>35</td><td>34</td><td>33</td><td>32</td><td>31</td><td>29</td></tr> <tr><td></td><td></td><td></td><td>25</td><td></td><td></td><td></td><td>20</td><td>19</td><td>18</td><td>16</td><td></td></tr> <tr><td></td><td></td><td>13</td><td>12</td><td></td><td>9</td><td>7</td><td></td><td></td><td></td><td></td><td></td></tr> </table>	56	55	54	53			49	48	47	46	44			40	39	37	36	35	34	33	32	31	29				25				20	19	18	16				13	12		9	7						
56	55	54	53			49	48	47	46	44																																													
		40	39	37	36	35	34	33	32	31	29																																												
			25				20	19	18	16																																													
		13	12		9	7																																																	
AVAILABLE	NOT APPLICABLE	34576-4703	F	0	G	BLUE	<table border="1"> <tr><td>56</td><td>55</td><td>54</td><td>53</td><td>51</td><td></td><td>49</td><td>48</td><td>47</td><td></td><td>44</td></tr> <tr><td></td><td></td><td>40</td><td>39</td><td>37</td><td>36</td><td>35</td><td>34</td><td>33</td><td></td><td>30</td></tr> <tr><td></td><td></td><td></td><td>25</td><td></td><td>22</td><td>21</td><td>20</td><td>19</td><td>18</td><td>16</td><td>15</td></tr> <tr><td></td><td></td><td>13</td><td>12</td><td></td><td>9</td><td>7</td><td></td><td></td><td>4</td><td>2</td><td>1</td></tr> </table>	56	55	54	53	51		49	48	47		44			40	39	37	36	35	34	33		30				25		22	21	20	19	18	16	15			13	12		9	7			4	2	1		
56	55	54	53	51		49	48	47		44																																													
		40	39	37	36	35	34	33		30																																													
			25		22	21	20	19	18	16	15																																												
		13	12		9	7			4	2	1																																												
AVAILABLE	NOT APPLICABLE	34576-4803	F	0	G	BLUE	<table border="1"> <tr><td></td><td>55</td><td>54</td><td>53</td><td>51</td><td></td><td>49</td><td>48</td><td>47</td><td></td><td>44</td></tr> <tr><td></td><td></td><td>40</td><td>39</td><td>37</td><td>36</td><td>35</td><td>34</td><td>33</td><td></td><td>29</td></tr> <tr><td></td><td></td><td></td><td>26</td><td></td><td></td><td></td><td>20</td><td>19</td><td>18</td><td>16</td><td>15</td></tr> <tr><td></td><td></td><td>13</td><td>12</td><td></td><td>9</td><td>7</td><td></td><td></td><td>4</td><td>2</td><td></td></tr> </table>		55	54	53	51		49	48	47		44			40	39	37	36	35	34	33		29				26				20	19	18	16	15			13	12		9	7			4	2			
	55	54	53	51		49	48	47		44																																													
		40	39	37	36	35	34	33		29																																													
			26				20	19	18	16	15																																												
		13	12		9	7			4	2																																													
ACTIVE	NOT APPLICABLE	34576-4903	F	9	G	BLUE	<table border="1"> <tr><td></td><td>55</td><td>54</td><td>53</td><td></td><td></td><td>49</td><td>48</td><td>47</td><td>46</td><td>44</td></tr> <tr><td></td><td></td><td>40</td><td></td><td></td><td>37</td><td>36</td><td>35</td><td>34</td><td>33</td><td>32</td><td>31</td></tr> <tr><td></td><td></td><td></td><td>26</td><td></td><td></td><td></td><td>20</td><td>19</td><td>18</td><td></td><td></td></tr> <tr><td></td><td></td><td>13</td><td>12</td><td></td><td>9</td><td>7</td><td></td><td></td><td></td><td></td><td></td></tr> </table>		55	54	53			49	48	47	46	44			40			37	36	35	34	33	32	31				26				20	19	18					13	12		9	7						
	55	54	53			49	48	47	46	44																																													
		40			37	36	35	34	33	32	31																																												
			26				20	19	18																																														
		13	12		9	7																																																	
AVAILABLE	NOT APPLICABLE	34576-5003	F	0	G	BLUE	<table border="1"> <tr><td></td><td>55</td><td>54</td><td>53</td><td></td><td></td><td>49</td><td>48</td><td>47</td><td></td><td>45</td><td>44</td></tr> <tr><td></td><td></td><td>40</td><td></td><td></td><td>37</td><td>36</td><td>35</td><td>34</td><td>33</td><td></td><td></td></tr> <tr><td></td><td></td><td></td><td>26</td><td></td><td></td><td></td><td>20</td><td>19</td><td>18</td><td></td><td></td></tr> <tr><td></td><td></td><td>13</td><td>12</td><td></td><td>9</td><td>7</td><td></td><td></td><td></td><td></td><td></td></tr> </table>		55	54	53			49	48	47		45	44			40			37	36	35	34	33						26				20	19	18					13	12		9	7					
	55	54	53			49	48	47		45	44																																												
		40			37	36	35	34	33																																														
			26				20	19	18																																														
		13	12		9	7																																																	
AVAILABLE	NOT APPLICABLE	34576-5103	F	0	G	BLUE	<table border="1"> <tr><td></td><td>55</td><td>54</td><td>53</td><td>51</td><td></td><td>49</td><td>48</td><td>47</td><td></td><td>44</td></tr> <tr><td></td><td></td><td>40</td><td></td><td>37</td><td>36</td><td>35</td><td>34</td><td>33</td><td></td><td>29</td></tr> <tr><td></td><td></td><td></td><td>26</td><td>24</td><td></td><td></td><td>20</td><td>19</td><td>18</td><td>16</td><td>15</td></tr> <tr><td></td><td></td><td>13</td><td>12</td><td></td><td>9</td><td>7</td><td></td><td></td><td>4</td><td>2</td><td></td></tr> </table>		55	54	53	51		49	48	47		44			40		37	36	35	34	33		29				26	24			20	19	18	16	15			13	12		9	7			4	2			
	55	54	53	51		49	48	47		44																																													
		40		37	36	35	34	33		29																																													
			26	24			20	19	18	16	15																																												
		13	12		9	7			4	2																																													

<b>ENTER DESCRIPTION</b> EC NO: VAAU2013-1350 DRAWN BY: 2013/02/26 CHKD: APPR: VIOSHY 2013/02/28 REV:	QUALITY SYMBOLS	GENERAL TOLERANCES (UNLESS SPECIFIED)	DIMENSION STYLE	SCALE	DESIGN UNITS	THIRD ANGLE PROJECTION
	▽=0	4 PLACES +--- INCH	MM ONLY	1:1	METRIC	
	▽=0	3 PLACES +---	DRAWN BY: SKRAJENDRANA 2011/01/25			TITLE
	▽=0	2 PLACES +---	CHECKED BY: DATE			MX123 18/49/56 CKT HRNS CONN ASSY
▽=0	1 PLACE +---	0 PLACE +---	APPROVED BY: DATE			<b>molex</b>
	ANGULAR ±	DRAFT WHERE APPLICABLE MUST REMAIN WITHIN DIMENSIONS	MATERIAL NO.		DOCUMENT NO.	SHEET NO.
	SEE BOM TABLE				SD-34576-001	8 OF 15
			THIS DRAWING CONTAINS INFORMATION THAT IS PROPRIETARY TO MOLEX INCORPORATED AND SHOULD NOT BE USED WITHOUT WRITTEN PERMISSION			



STATUS	GM PART #	MATERIAL #	PART/MATERIAL REVISION	WIRE DRESS OPTION	KEY OPTION	COLOR (TPA)	NUMBERS INDICATE CAVITIES OPEN FOR CIRCUITS																																																												
AVAILABLE	NOT APPLICABLE	34576-5203	F	0	G	BLUE	<table border="1"> <tr><td>56</td><td>55</td><td>54</td><td>53</td><td></td><td></td><td>49</td><td>48</td><td>47</td><td></td><td>44</td></tr> <tr><td></td><td>40</td><td>39</td><td></td><td>37</td><td>36</td><td>35</td><td>34</td><td>33</td><td></td><td>29</td></tr> <tr><td></td><td></td><td></td><td></td><td></td><td></td><td></td><td>20</td><td>19</td><td>18</td><td></td></tr> <tr><td></td><td>13</td><td>12</td><td></td><td></td><td>9</td><td>7</td><td></td><td></td><td></td><td></td></tr> </table>	56	55	54	53			49	48	47		44		40	39		37	36	35	34	33		29								20	19	18			13	12			9	7																				
56	55	54	53			49	48	47		44																																																									
	40	39		37	36	35	34	33		29																																																									
							20	19	18																																																										
	13	12			9	7																																																													
AVAILABLE	NOT APPLICABLE	34576-5403	F	0	G	BLUE	<table border="1"> <tr><td></td><td>55</td><td></td><td>53</td><td></td><td>51</td><td>49</td><td>48</td><td>47</td><td></td><td>44</td></tr> <tr><td></td><td></td><td>40</td><td>39</td><td></td><td>37</td><td>36</td><td>35</td><td>34</td><td>33</td><td>30</td></tr> <tr><td></td><td></td><td>26</td><td>25</td><td></td><td></td><td>22</td><td>21</td><td>20</td><td>19</td><td>18</td></tr> <tr><td></td><td>13</td><td>12</td><td></td><td></td><td>9</td><td>7</td><td></td><td>4</td><td></td><td>2</td></tr> </table>		55		53		51	49	48	47		44			40	39		37	36	35	34	33	30			26	25			22	21	20	19	18		13	12			9	7		4		2																
	55		53		51	49	48	47		44																																																									
		40	39		37	36	35	34	33	30																																																									
		26	25			22	21	20	19	18																																																									
	13	12			9	7		4		2																																																									
AVAILABLE	NOT APPLICABLE	34576-5503	F	0	G	BLUE	<table border="1"> <tr><td>56</td><td>55</td><td></td><td>53</td><td></td><td>51</td><td>49</td><td>48</td><td>47</td><td></td><td>44</td></tr> <tr><td></td><td></td><td>40</td><td>39</td><td></td><td>37</td><td>36</td><td>35</td><td>34</td><td>33</td><td>30</td></tr> <tr><td></td><td></td><td></td><td>25</td><td></td><td></td><td>22</td><td>21</td><td>20</td><td>19</td><td>18</td></tr> <tr><td></td><td>13</td><td>12</td><td></td><td></td><td>9</td><td>7</td><td></td><td></td><td>4</td><td>2</td></tr> </table>	56	55		53		51	49	48	47		44			40	39		37	36	35	34	33	30				25			22	21	20	19	18		13	12			9	7			4	2																
56	55		53		51	49	48	47		44																																																									
		40	39		37	36	35	34	33	30																																																									
			25			22	21	20	19	18																																																									
	13	12			9	7			4	2																																																									
AVAILABLE	NOT APPLICABLE	34576-5603	F	0	G	BLUE	<table border="1"> <tr><td>56</td><td>55</td><td></td><td>53</td><td></td><td></td><td>49</td><td>48</td><td>47</td><td>46</td><td>44</td></tr> <tr><td></td><td></td><td>40</td><td>39</td><td></td><td>37</td><td>36</td><td>35</td><td>34</td><td>33</td><td>31</td></tr> <tr><td></td><td></td><td></td><td>25</td><td></td><td></td><td>22</td><td>21</td><td>20</td><td>19</td><td>18</td></tr> <tr><td></td><td>13</td><td>12</td><td></td><td></td><td>9</td><td>7</td><td></td><td></td><td>4</td><td>2</td></tr> </table>	56	55		53			49	48	47	46	44			40	39		37	36	35	34	33	31				25			22	21	20	19	18		13	12			9	7			4	2																
56	55		53			49	48	47	46	44																																																									
		40	39		37	36	35	34	33	31																																																									
			25			22	21	20	19	18																																																									
	13	12			9	7			4	2																																																									
AVAILABLE	NOT APPLICABLE	34576-5703	F	0	G	BLUE	<table border="1"> <tr><td></td><td>55</td><td></td><td>53</td><td></td><td></td><td>49</td><td>48</td><td>47</td><td>46</td><td>44</td></tr> <tr><td></td><td></td><td>40</td><td>39</td><td></td><td>37</td><td>36</td><td>35</td><td>34</td><td>33</td><td>31</td></tr> <tr><td></td><td></td><td>26</td><td>25</td><td></td><td></td><td>22</td><td>21</td><td>20</td><td>19</td><td>18</td></tr> <tr><td></td><td>13</td><td>12</td><td></td><td></td><td>9</td><td>7</td><td></td><td></td><td>4</td><td>2</td></tr> </table>		55		53			49	48	47	46	44			40	39		37	36	35	34	33	31			26	25			22	21	20	19	18		13	12			9	7			4	2																
	55		53			49	48	47	46	44																																																									
		40	39		37	36	35	34	33	31																																																									
		26	25			22	21	20	19	18																																																									
	13	12			9	7			4	2																																																									
AVAILABLE	NOT APPLICABLE	34576-5803	F	0	G	BLUE	<table border="1"> <tr><td></td><td>55</td><td></td><td>53</td><td></td><td></td><td>49</td><td>48</td><td>47</td><td>46</td><td>45</td><td>44</td></tr> <tr><td></td><td></td><td>40</td><td>39</td><td></td><td>37</td><td>36</td><td>35</td><td>34</td><td>33</td><td></td><td></td></tr> <tr><td></td><td></td><td>26</td><td>25</td><td></td><td></td><td></td><td>20</td><td>19</td><td>18</td><td></td><td></td></tr> <tr><td></td><td>13</td><td>12</td><td></td><td></td><td>9</td><td>7</td><td></td><td></td><td></td><td></td><td></td></tr> </table>		55		53			49	48	47	46	45	44			40	39		37	36	35	34	33					26	25				20	19	18				13	12			9	7																	
	55		53			49	48	47	46	45	44																																																								
		40	39		37	36	35	34	33																																																										
		26	25				20	19	18																																																										
	13	12			9	7																																																													
AVAILABLE	NOT APPLICABLE	34576-5903	F	0	G	BLUE	<table border="1"> <tr><td>56</td><td></td><td></td><td>53</td><td>52</td><td></td><td></td><td></td><td>47</td><td>45</td><td>43</td></tr> <tr><td></td><td>41</td><td>40</td><td>39</td><td>38</td><td></td><td></td><td></td><td>34</td><td>33</td><td>31</td></tr> <tr><td></td><td>28</td><td>27</td><td>26</td><td>25</td><td>24</td><td></td><td></td><td>20</td><td>19</td><td>18</td></tr> <tr><td></td><td>13</td><td>12</td><td>11</td><td>10</td><td></td><td></td><td></td><td></td><td></td><td>3</td></tr> <tr><td></td><td></td><td></td><td></td><td></td><td></td><td></td><td></td><td></td><td></td><td>2</td></tr> </table>	56			53	52				47	45	43		41	40	39	38				34	33	31		28	27	26	25	24			20	19	18		13	12	11	10						3											2					
56			53	52				47	45	43																																																									
	41	40	39	38				34	33	31																																																									
	28	27	26	25	24			20	19	18																																																									
	13	12	11	10						3																																																									
										2																																																									
AVAILABLE	NOT APPLICABLE	34576-6003	F	0	G	BLUE	<table border="1"> <tr><td>56</td><td></td><td></td><td>53</td><td>52</td><td></td><td>50</td><td></td><td></td><td>47</td><td>45</td><td>43</td></tr> <tr><td></td><td></td><td>40</td><td>39</td><td>38</td><td></td><td></td><td></td><td>34</td><td>33</td><td>31</td><td>30</td></tr> <tr><td></td><td>28</td><td>27</td><td>26</td><td>25</td><td>24</td><td></td><td></td><td>20</td><td>19</td><td>18</td><td>16</td></tr> <tr><td></td><td>14</td><td>13</td><td>12</td><td>11</td><td>10</td><td></td><td></td><td></td><td>5</td><td>4</td><td>3</td></tr> <tr><td></td><td></td><td></td><td></td><td></td><td></td><td></td><td></td><td></td><td></td><td></td><td>2</td></tr> </table>	56			53	52		50			47	45	43			40	39	38				34	33	31	30		28	27	26	25	24			20	19	18	16		14	13	12	11	10				5	4	3												2
56			53	52		50			47	45	43																																																								
		40	39	38				34	33	31	30																																																								
	28	27	26	25	24			20	19	18	16																																																								
	14	13	12	11	10				5	4	3																																																								
											2																																																								
AVAILABLE	NOT APPLICABLE	34576-6103	F	0	G	BLUE	<table border="1"> <tr><td>56</td><td>55</td><td>54</td><td>53</td><td></td><td>51</td><td>49</td><td>48</td><td>47</td><td></td><td>44</td></tr> <tr><td></td><td></td><td>40</td><td>39</td><td></td><td>37</td><td>36</td><td>35</td><td>34</td><td>33</td><td></td></tr> <tr><td></td><td></td><td></td><td></td><td></td><td></td><td></td><td></td><td>20</td><td>19</td><td>18</td></tr> <tr><td></td><td>13</td><td>12</td><td></td><td></td><td>9</td><td>7</td><td></td><td></td><td>4</td><td>2</td></tr> </table>	56	55	54	53		51	49	48	47		44			40	39		37	36	35	34	33										20	19	18		13	12			9	7			4	2																
56	55	54	53		51	49	48	47		44																																																									
		40	39		37	36	35	34	33																																																										
								20	19	18																																																									
	13	12			9	7			4	2																																																									

<b>ENTER DESCRIPTION</b> EC NO: UAU2013-1350 DRAWN BY: 2013/02/26 CHKD: 2013/02/28 APPR: VIOSHY REV:	QUALITY SYMBOLS ∇=0 ∇=0 ∇=0	GENERAL TOLERANCES (UNLESS SPECIFIED) mm INCH 4 PLACES ± --- ± --- 3 PLACES ± --- ± --- 2 PLACES ± --- ± --- 1 PLACE ± --- ± --- 0 PLACE ± --- ± ---	DIMENSION STYLE <b>MM ONLY</b>	SCALE <b>2:1</b>	DESIGN UNITS <b>METRIC</b>	THIRD ANGLE PROJECTION
	DRAWN BY: SKRAJENDRANA 2011/01/25 CHECKED BY: DATE		APPROVED BY: DATE		TITLE <b>MX123 18/49/56 CKT HRNS CONN ASSY</b>	
	MATERIAL NO. SEE BOM TABLE		DOCUMENT NO. SD-34576-001		SHEET NO. 9 OF 15	
	THIS DRAWING CONTAINS INFORMATION THAT IS PROPRIETARY TO MOLEX INCORPORATED AND SHOULD NOT BE USED WITHOUT WRITTEN PERMISSION					

STATUS	GM PART #	MATERIAL #	PART/MATERIAL REVISION	WIRE DRESS OPTION	KEY OPTION	COLOR (TFA)	NUMBERS INDICATE CAVITIES OPEN FOR CIRCUITS																																																												
AVAILABLE	NOT APPLICABLE	34576-6203	G	0	G	BLUE	<table border="1"> <tr><td>55</td><td>54</td><td>53</td><td></td><td></td><td>49</td><td>48</td><td>47</td><td>46</td><td>45</td><td>44</td></tr> <tr><td></td><td>40</td><td></td><td>37</td><td>36</td><td>35</td><td>34</td><td>33</td><td></td><td></td><td></td></tr> <tr><td></td><td>26</td><td></td><td></td><td></td><td></td><td>20</td><td>19</td><td>18</td><td></td><td></td></tr> <tr><td>13</td><td>12</td><td></td><td>9</td><td>7</td><td></td><td></td><td></td><td></td><td></td><td></td></tr> </table>	55	54	53			49	48	47	46	45	44		40		37	36	35	34	33					26					20	19	18			13	12		9	7																						
55	54	53			49	48	47	46	45	44																																																									
	40		37	36	35	34	33																																																												
	26					20	19	18																																																											
13	12		9	7																																																															
AVAILABLE	NOT APPLICABLE	34576-6303	G	0	G	BLUE	<table border="1"> <tr><td>55</td><td>54</td><td>53</td><td>51</td><td>49</td><td>48</td><td>47</td><td></td><td></td><td>44</td><td></td></tr> <tr><td></td><td>40</td><td></td><td>37</td><td>36</td><td>35</td><td>34</td><td>33</td><td></td><td></td><td>29</td></tr> <tr><td></td><td>26</td><td></td><td></td><td></td><td></td><td>20</td><td>19</td><td>18</td><td>16</td><td>15</td></tr> <tr><td>13</td><td>12</td><td></td><td>9</td><td>7</td><td></td><td></td><td>4</td><td>2</td><td></td><td></td></tr> </table>	55	54	53	51	49	48	47			44			40		37	36	35	34	33			29		26					20	19	18	16	15	13	12		9	7			4	2																		
55	54	53	51	49	48	47			44																																																										
	40		37	36	35	34	33			29																																																									
	26					20	19	18	16	15																																																									
13	12		9	7			4	2																																																											
AVAILABLE	NOT APPLICABLE	34576-6403	G	0	G	BLUE	<table border="1"> <tr><td>55</td><td>54</td><td></td><td></td><td>49</td><td>48</td><td>47</td><td></td><td></td><td>44</td><td></td></tr> <tr><td></td><td>41</td><td>40</td><td></td><td>37</td><td>36</td><td>35</td><td>34</td><td>33</td><td></td><td></td></tr> <tr><td></td><td></td><td></td><td></td><td></td><td></td><td></td><td>20</td><td>19</td><td>18</td><td></td></tr> <tr><td>13</td><td>12</td><td></td><td>9</td><td>8</td><td>7</td><td></td><td></td><td></td><td>3</td><td></td></tr> </table>	55	54			49	48	47			44			41	40		37	36	35	34	33										20	19	18		13	12		9	8	7				3																	
55	54			49	48	47			44																																																										
	41	40		37	36	35	34	33																																																											
							20	19	18																																																										
13	12		9	8	7				3																																																										
AVAILABLE	NOT APPLICABLE	34576-6503	G	0	G	BLUE	<table border="1"> <tr><td></td><td>54</td><td></td><td></td><td></td><td></td><td>47</td><td>46</td><td>45</td><td></td><td>43</td></tr> <tr><td></td><td>41</td><td>40</td><td>39</td><td>38</td><td>37</td><td></td><td>33</td><td>32</td><td>31</td><td>30</td></tr> <tr><td>28</td><td>27</td><td>26</td><td>25</td><td>24</td><td>23</td><td></td><td>20</td><td>19</td><td>18</td><td>16</td></tr> <tr><td>13</td><td>12</td><td>11</td><td>10</td><td>9</td><td></td><td></td><td></td><td></td><td>3</td><td>2</td></tr> </table>		54					47	46	45		43		41	40	39	38	37		33	32	31	30	28	27	26	25	24	23		20	19	18	16	13	12	11	10	9					3	2																
	54					47	46	45		43																																																									
	41	40	39	38	37		33	32	31	30																																																									
28	27	26	25	24	23		20	19	18	16																																																									
13	12	11	10	9					3	2																																																									
AVAILABLE	NOT APPLICABLE	34576-6603	G	0	G	BLUE	<table border="1"> <tr><td></td><td>54</td><td></td><td></td><td></td><td></td><td>47</td><td>46</td><td>45</td><td></td><td>43</td></tr> <tr><td></td><td>41</td><td>40</td><td>39</td><td>38</td><td>37</td><td></td><td>34</td><td>33</td><td>32</td><td>31</td></tr> <tr><td>28</td><td>27</td><td>26</td><td>25</td><td>24</td><td>23</td><td></td><td>20</td><td>19</td><td>18</td><td>16</td></tr> <tr><td>13</td><td>12</td><td>11</td><td>10</td><td>9</td><td></td><td></td><td></td><td></td><td>3</td><td>2</td></tr> </table>		54					47	46	45		43		41	40	39	38	37		34	33	32	31	28	27	26	25	24	23		20	19	18	16	13	12	11	10	9					3	2																
	54					47	46	45		43																																																									
	41	40	39	38	37		34	33	32	31																																																									
28	27	26	25	24	23		20	19	18	16																																																									
13	12	11	10	9					3	2																																																									
AVAILABLE	NOT APPLICABLE	34576-6703	G	0	G	BLUE	<table border="1"> <tr><td>55</td><td></td><td></td><td>52</td><td>51</td><td></td><td></td><td>48</td><td></td><td>46</td><td>45</td><td>43</td></tr> <tr><td></td><td>41</td><td>40</td><td>39</td><td>38</td><td></td><td></td><td></td><td></td><td>33</td><td>32</td><td>31</td></tr> <tr><td>28</td><td></td><td>26</td><td>25</td><td>24</td><td></td><td></td><td></td><td></td><td>20</td><td>19</td><td>18</td></tr> <tr><td>13</td><td>12</td><td></td><td>11</td><td>10</td><td></td><td></td><td></td><td></td><td></td><td>3</td><td>2</td></tr> <tr><td></td><td></td><td></td><td></td><td></td><td></td><td></td><td></td><td></td><td></td><td></td><td>1</td></tr> </table>	55			52	51			48		46	45	43		41	40	39	38					33	32	31	28		26	25	24					20	19	18	13	12		11	10						3	2												1
55			52	51			48		46	45	43																																																								
	41	40	39	38					33	32	31																																																								
28		26	25	24					20	19	18																																																								
13	12		11	10						3	2																																																								
											1																																																								
AVAILABLE	NOT APPLICABLE	34576-6803	G	0	G	BLUE	<table border="1"> <tr><td></td><td></td><td></td><td></td><td>52</td><td></td><td></td><td>48</td><td></td><td>46</td><td>45</td><td>43</td></tr> <tr><td></td><td>41</td><td>40</td><td>39</td><td>38</td><td></td><td></td><td></td><td></td><td>33</td><td>32</td><td>31</td></tr> <tr><td>28</td><td></td><td>26</td><td>25</td><td>24</td><td></td><td></td><td></td><td></td><td>20</td><td>19</td><td>18</td></tr> <tr><td>13</td><td>12</td><td></td><td>11</td><td>10</td><td></td><td></td><td></td><td></td><td></td><td>3</td><td>2</td></tr> <tr><td></td><td></td><td></td><td></td><td></td><td></td><td></td><td></td><td></td><td></td><td></td><td>1</td></tr> </table>					52			48		46	45	43		41	40	39	38					33	32	31	28		26	25	24					20	19	18	13	12		11	10						3	2												1
				52			48		46	45	43																																																								
	41	40	39	38					33	32	31																																																								
28		26	25	24					20	19	18																																																								
13	12		11	10						3	2																																																								
											1																																																								
AVAILABLE	NOT APPLICABLE	34576-6813	G	0	G	BLUE	<table border="1"> <tr><td>56</td><td>55</td><td>54</td><td>53</td><td>51</td><td>50</td><td>49</td><td></td><td>47</td><td></td><td></td><td>44</td></tr> <tr><td></td><td></td><td></td><td>39</td><td>37</td><td>36</td><td>35</td><td>34</td><td></td><td></td><td></td><td></td></tr> <tr><td></td><td>27</td><td></td><td>25</td><td>23</td><td>22</td><td>21</td><td></td><td></td><td>17</td><td></td><td></td></tr> <tr><td>14</td><td></td><td></td><td>11</td><td>9</td><td>8</td><td>7</td><td>6</td><td>5</td><td>4</td><td></td><td></td></tr> </table>	56	55	54	53	51	50	49		47			44				39	37	36	35	34						27		25	23	22	21			17			14			11	9	8	7	6	5	4														
56	55	54	53	51	50	49		47			44																																																								
			39	37	36	35	34																																																												
	27		25	23	22	21			17																																																										
14			11	9	8	7	6	5	4																																																										
AVAILABLE	NOT APPLICABLE	34576-6823	G	0	G	BLUE	<table border="1"> <tr><td>56</td><td>54</td><td>53</td><td></td><td></td><td>50</td><td>49</td><td></td><td>47</td><td></td><td>44</td></tr> <tr><td></td><td></td><td></td><td></td><td></td><td>39</td><td>37</td><td>36</td><td>35</td><td>34</td><td></td><td></td></tr> <tr><td></td><td>27</td><td></td><td>25</td><td></td><td>23</td><td>22</td><td>21</td><td></td><td></td><td>17</td><td></td></tr> <tr><td>14</td><td></td><td></td><td>11</td><td></td><td>9</td><td>8</td><td>7</td><td>6</td><td>5</td><td>4</td><td></td></tr> </table>	56	54	53			50	49		47		44						39	37	36	35	34				27		25		23	22	21			17		14			11		9	8	7	6	5	4														
56	54	53			50	49		47		44																																																									
					39	37	36	35	34																																																										
	27		25		23	22	21			17																																																									
14			11		9	8	7	6	5	4																																																									

<b>ENTER DESCRIPTION</b> EC NO: UAU2013-1350 DRAWN BY: TJJ CHKD: T38 APPR: IKOSHY 2013/02/28	QUALITY SYMBOLS ∇=0 ∇=0 ∇=0	GENERAL TOLERANCES (UNLESS SPECIFIED) mm INCH 4 PLACES ±--- ±--- 3 PLACES ±--- ±--- 2 PLACES ±--- ±--- 1 PLACE ±--- ±--- 0 PLACE ±--- ±---	DIMENSION STYLE <b>MM ONLY</b>	SCALE <b>1.5:1</b>	DESIGN UNITS <b>METRIC</b>	THIRD ANGLE PROJECTION	
	DRAFT WHERE APPLICABLE MUST REMAIN WITHIN DIMENSIONS		DRAWN BY DATE SKRAJENDRANA 2011/01/25	CHECKED BY DATE	TITLE <b>MX123 18/49/56 CKT HRNS CONN ASSY</b>	APPROVED BY DATE	
	ANGULAR ±---°		MATERIAL NO.	DOCUMENT NO. <b>SD-34576-001</b>	SHEET NO. 10 OF 45	<b>molex</b>	
	SEE BOM TABLE		THIS DRAWING CONTAINS INFORMATION THAT IS PROPRIETARY TO MOLEX INCORPORATED AND SHOULD NOT BE USED WITHOUT WRITTEN PERMISSION				

20 19 18 17 16 15 14 13 12 11 10 9 8 7 6 5 4 3 2 1

STATUS	GM PART #	MATERIAL #	PART/MATERIAL REVISION	WIRE DRESS OPTION	KEY OPTION	COLOR (TPA)	NUMBERS INDICATE CAVITIES OPEN FOR CIRCUITS																																																												
AVAILABLE	NOT APPLICABLE	34576-6833	G	0	G	BLUE	<table border="1"> <tr><td>56</td><td>54</td><td>53</td><td></td><td></td><td></td><td>50</td><td>49</td><td></td><td>47</td><td></td><td></td><td></td><td></td><td></td></tr> <tr><td></td><td></td><td></td><td></td><td></td><td></td><td></td><td>21</td><td></td><td></td><td></td><td>17</td><td></td><td></td><td></td></tr> <tr><td>14</td><td></td><td>11</td><td>9</td><td>8</td><td>7</td><td>6</td><td>5</td><td>4</td><td></td><td></td><td></td><td></td><td></td><td></td></tr> </table>	56	54	53				50	49		47													21				17				14		11	9	8	7	6	5	4																					
56	54	53				50	49		47																																																										
							21				17																																																								
14		11	9	8	7	6	5	4																																																											
AVAILABLE	NOT APPLICABLE	34576-6843	G	0	G	BLUE	<table border="1"> <tr><td>56</td><td>54</td><td>53</td><td>52</td><td></td><td></td><td></td><td></td><td></td><td>47</td><td>46</td><td>45</td><td>43</td><td></td><td></td></tr> <tr><td>41</td><td>40</td><td>39</td><td>38</td><td>37</td><td></td><td></td><td></td><td></td><td>33</td><td>32</td><td>31</td><td>30</td><td>29</td><td></td></tr> <tr><td>28</td><td>27</td><td>26</td><td>25</td><td>24</td><td>23</td><td></td><td></td><td>20</td><td>19</td><td>18</td><td></td><td>16</td><td></td><td></td></tr> <tr><td>13</td><td>12</td><td>11</td><td>10</td><td>9</td><td></td><td></td><td></td><td></td><td></td><td></td><td>3</td><td>2</td><td></td><td></td></tr> </table>	56	54	53	52						47	46	45	43			41	40	39	38	37					33	32	31	30	29		28	27	26	25	24	23			20	19	18		16			13	12	11	10	9							3	2		
56	54	53	52						47	46	45	43																																																							
41	40	39	38	37					33	32	31	30	29																																																						
28	27	26	25	24	23			20	19	18		16																																																							
13	12	11	10	9							3	2																																																							
AVAILABLE	NOT APPLICABLE	34576-6853	G	0	G	BLUE	<table border="1"> <tr><td>56</td><td>54</td><td>53</td><td>52</td><td></td><td></td><td></td><td></td><td></td><td>47</td><td>46</td><td>45</td><td>43</td><td></td><td></td></tr> <tr><td>41</td><td>40</td><td>39</td><td>38</td><td>37</td><td></td><td></td><td></td><td>34</td><td>33</td><td>32</td><td>31</td><td>30</td><td>29</td><td></td></tr> <tr><td>28</td><td>27</td><td>26</td><td>25</td><td>24</td><td>23</td><td></td><td></td><td>20</td><td>19</td><td>18</td><td></td><td>16</td><td></td><td></td></tr> <tr><td>13</td><td>12</td><td>11</td><td>10</td><td>9</td><td></td><td></td><td></td><td></td><td></td><td></td><td>3</td><td>2</td><td></td><td></td></tr> </table>	56	54	53	52						47	46	45	43			41	40	39	38	37				34	33	32	31	30	29		28	27	26	25	24	23			20	19	18		16			13	12	11	10	9							3	2		
56	54	53	52						47	46	45	43																																																							
41	40	39	38	37				34	33	32	31	30	29																																																						
28	27	26	25	24	23			20	19	18		16																																																							
13	12	11	10	9							3	2																																																							
AVAILABLE	NOT APPLICABLE	34576-6863	G	0	G	BLUE	<table border="1"> <tr><td></td><td>55</td><td></td><td>52</td><td>51</td><td></td><td></td><td></td><td>48</td><td>46</td><td>45</td><td>43</td><td></td><td></td><td></td></tr> <tr><td>41</td><td>40</td><td></td><td>38</td><td></td><td></td><td></td><td></td><td>33</td><td>32</td><td>31</td><td>30</td><td>29</td><td></td><td></td></tr> <tr><td>28</td><td></td><td>26</td><td>24</td><td></td><td></td><td></td><td></td><td>20</td><td>19</td><td>18</td><td></td><td>16</td><td>15</td><td></td></tr> <tr><td>13</td><td>12</td><td></td><td>10</td><td></td><td></td><td></td><td></td><td></td><td></td><td></td><td>3</td><td>2</td><td>1</td><td></td></tr> </table>		55		52	51				48	46	45	43				41	40		38					33	32	31	30	29			28		26	24					20	19	18		16	15		13	12		10								3	2	1	
	55		52	51				48	46	45	43																																																								
41	40		38					33	32	31	30	29																																																							
28		26	24					20	19	18		16	15																																																						
13	12		10								3	2	1																																																						
AVAILABLE	NOT APPLICABLE	34576-6873	G	0	G	BLUE	<table border="1"> <tr><td></td><td></td><td></td><td>52</td><td></td><td></td><td></td><td></td><td>48</td><td>46</td><td>45</td><td>43</td><td></td><td></td><td></td></tr> <tr><td>41</td><td>40</td><td></td><td>38</td><td></td><td></td><td></td><td></td><td>33</td><td>32</td><td>31</td><td>30</td><td>29</td><td></td><td></td></tr> <tr><td>28</td><td></td><td>26</td><td>24</td><td></td><td></td><td></td><td></td><td>20</td><td>19</td><td>18</td><td></td><td>16</td><td>15</td><td></td></tr> <tr><td>13</td><td>12</td><td></td><td>10</td><td></td><td></td><td></td><td></td><td></td><td></td><td></td><td>3</td><td>2</td><td>1</td><td></td></tr> </table>				52					48	46	45	43				41	40		38					33	32	31	30	29			28		26	24					20	19	18		16	15		13	12		10								3	2	1	
			52					48	46	45	43																																																								
41	40		38					33	32	31	30	29																																																							
28		26	24					20	19	18		16	15																																																						
13	12		10								3	2	1																																																						
AVAILABLE	NOT APPLICABLE	34576-6883	G	0	G	BLUE	<table border="1"> <tr><td>56</td><td>54</td><td></td><td>52</td><td></td><td></td><td></td><td></td><td></td><td>47</td><td>46</td><td>45</td><td>43</td><td></td><td></td></tr> <tr><td>41</td><td>40</td><td>39</td><td>38</td><td>37</td><td></td><td></td><td></td><td></td><td>34</td><td>33</td><td>32</td><td>31</td><td>30</td><td>29</td></tr> <tr><td>28</td><td>27</td><td>26</td><td>25</td><td>24</td><td>23</td><td></td><td></td><td></td><td>20</td><td>19</td><td>18</td><td></td><td>16</td><td></td></tr> <tr><td>13</td><td>12</td><td>11</td><td>10</td><td>9</td><td></td><td></td><td></td><td></td><td></td><td></td><td>3</td><td>2</td><td></td><td></td></tr> </table>	56	54		52						47	46	45	43			41	40	39	38	37					34	33	32	31	30	29	28	27	26	25	24	23				20	19	18		16		13	12	11	10	9							3	2		
56	54		52						47	46	45	43																																																							
41	40	39	38	37					34	33	32	31	30	29																																																					
28	27	26	25	24	23				20	19	18		16																																																						
13	12	11	10	9							3	2																																																							
AVAILABLE	NOT APPLICABLE	34576-6893	G	0	G	BLUE	<table border="1"> <tr><td></td><td>54</td><td>53</td><td></td><td></td><td></td><td></td><td></td><td></td><td>47</td><td>46</td><td>45</td><td></td><td></td><td></td></tr> <tr><td>41</td><td>40</td><td></td><td>38</td><td></td><td></td><td></td><td></td><td></td><td>33</td><td>32</td><td>31</td><td>30</td><td>29</td><td></td></tr> <tr><td>28</td><td>27</td><td>26</td><td>25</td><td>24</td><td></td><td></td><td></td><td></td><td>20</td><td>19</td><td>18</td><td></td><td>16</td><td></td></tr> <tr><td>13</td><td>12</td><td>11</td><td>10</td><td></td><td></td><td></td><td>8</td><td></td><td></td><td></td><td>3</td><td>2</td><td></td><td></td></tr> </table>		54	53							47	46	45				41	40		38						33	32	31	30	29		28	27	26	25	24					20	19	18		16		13	12	11	10				8				3	2		
	54	53							47	46	45																																																								
41	40		38						33	32	31	30	29																																																						
28	27	26	25	24					20	19	18		16																																																						
13	12	11	10				8				3	2																																																							
ACTIVE	NOT APPLICABLE	34576-6913	F	9	G	BLUE	<table border="1"> <tr><td></td><td>54</td><td>53</td><td></td><td></td><td></td><td></td><td></td><td></td><td>47</td><td>46</td><td>45</td><td>43</td><td></td><td></td></tr> <tr><td>41</td><td>40</td><td></td><td>38</td><td></td><td></td><td></td><td></td><td></td><td>33</td><td>32</td><td>31</td><td>30</td><td>29</td><td></td></tr> <tr><td>28</td><td>27</td><td>26</td><td>25</td><td>24</td><td></td><td></td><td></td><td></td><td>20</td><td>19</td><td>18</td><td></td><td>16</td><td></td></tr> <tr><td>13</td><td>12</td><td>11</td><td>10</td><td></td><td></td><td></td><td>8</td><td></td><td></td><td></td><td>3</td><td>2</td><td></td><td></td></tr> </table>		54	53							47	46	45	43			41	40		38						33	32	31	30	29		28	27	26	25	24					20	19	18		16		13	12	11	10				8				3	2		
	54	53							47	46	45	43																																																							
41	40		38						33	32	31	30	29																																																						
28	27	26	25	24					20	19	18		16																																																						
13	12	11	10				8				3	2																																																							
ACTIVE	NOT APPLICABLE	34576-6923	F	9	G	BLUE	<table border="1"> <tr><td></td><td>54</td><td>53</td><td></td><td></td><td></td><td></td><td></td><td></td><td>47</td><td>46</td><td>45</td><td>43</td><td></td><td></td></tr> <tr><td>41</td><td>40</td><td>39</td><td>38</td><td></td><td></td><td></td><td></td><td></td><td>33</td><td>32</td><td>31</td><td>30</td><td>29</td><td></td></tr> <tr><td>28</td><td>27</td><td>26</td><td>25</td><td>24</td><td>23</td><td></td><td></td><td></td><td>20</td><td>19</td><td>18</td><td></td><td>16</td><td></td></tr> <tr><td>13</td><td>12</td><td>11</td><td>10</td><td>9</td><td>8</td><td></td><td></td><td></td><td></td><td></td><td>3</td><td>2</td><td></td><td></td></tr> </table>		54	53							47	46	45	43			41	40	39	38						33	32	31	30	29		28	27	26	25	24	23				20	19	18		16		13	12	11	10	9	8						3	2		
	54	53							47	46	45	43																																																							
41	40	39	38						33	32	31	30	29																																																						
28	27	26	25	24	23				20	19	18		16																																																						
13	12	11	10	9	8						3	2																																																							

<b>ENTER DESCRIPTION</b> EC NO: UAU2013-1350 DRAWN BY: SKRAJENDRANA CHKD: SKRAJENDRANA APPR: IKOSHY REV: TJSB DESCRIPTION: 2013/02/28	<b>QUALITY SYMBOLS</b> ∇=0 ∇=0 ∇=0	<b>GENERAL TOLERANCES (UNLESS SPECIFIED)</b> <table border="1"> <tr><td></td><td>mm</td><td>INCH</td></tr> <tr><td>4 PLACES</td><td>±----</td><td>±----</td></tr> <tr><td>3 PLACES</td><td>±----</td><td>±----</td></tr> <tr><td>2 PLACES</td><td>±----</td><td>±----</td></tr> <tr><td>1 PLACE</td><td>±----</td><td>±----</td></tr> <tr><td>0 PLACE</td><td>±----</td><td>±----</td></tr> </table>		mm	INCH	4 PLACES	±----	±----	3 PLACES	±----	±----	2 PLACES	±----	±----	1 PLACE	±----	±----	0 PLACE	±----	±----	<b>DIMENSION STYLE</b> <b>MM ONLY</b>	<b>SCALE</b> <b>1:1</b>	<b>DESIGN UNITS</b> <b>METRIC</b>	<b>THIRD ANGLE PROJECTION</b>
		mm	INCH																					
	4 PLACES	±----	±----																					
	3 PLACES	±----	±----																					
2 PLACES	±----	±----																						
1 PLACE	±----	±----																						
0 PLACE	±----	±----																						
<b>DATE</b> 2011/01/25	<b>DATE</b> 2011/01/25	<b>DATE</b> 2011/01/25	<b>TITLE</b> MX123 18/49/56 CKT HRNS CONN ASSY	<b>DOCUMENT NO.</b> SD-34576-001	<b>SHEET NO.</b> 11 OF 45																			
<b>ANGULAR ±----</b> <b>DRAFT WHERE APPLICABLE</b> <b>MUST REMAIN WITHIN DIMENSIONS</b>	<b>SEE BOM TABLE</b>	<b>THIS DRAWING CONTAINS INFORMATION THAT IS PROPRIETARY TO MOLEX INCORPORATED AND SHOULD NOT BE USED WITHOUT WRITTEN PERMISSION</b>																						

STATUS	GM PART #	MATERIAL #	PART/MATERIAL REVISION	WIRE DRESS OPTION	KEY OPTION	COLOR (TPA)	NUMBERS INDICATE CAVITIES OPEN FOR CIRCUITS																																																																	
TOOL DES. REL.	NOT APPLICABLE	34851-0025	A	0	G	BLUE																																																																		
TOOL DES. REL.	NOT APPLICABLE	34851-0026	A	0	H	ST GRY																																																																		
AVAILABLE	NOT APPLICABLE	34576-6933	G	0	G	BLUE	<table border="1"> <tr><td>55</td><td>54</td><td>53</td><td></td><td></td><td></td><td>49</td><td>48</td><td>47</td><td>46</td><td>45</td><td>44</td></tr> <tr><td></td><td>40</td><td></td><td></td><td></td><td></td><td>37</td><td>36</td><td>35</td><td>34</td><td>33</td><td></td></tr> <tr><td></td><td></td><td>26</td><td></td><td></td><td></td><td></td><td></td><td>20</td><td>19</td><td>18</td><td></td></tr> <tr><td></td><td></td><td></td><td></td><td></td><td></td><td>9</td><td>7</td><td></td><td></td><td></td><td></td></tr> </table>	55	54	53				49	48	47	46	45	44		40					37	36	35	34	33				26						20	19	18								9	7																					
55	54	53				49	48	47	46	45	44																																																													
	40					37	36	35	34	33																																																														
		26						20	19	18																																																														
						9	7																																																																	
AVAILABLE	NOT APPLICABLE	34576-6943	G	9	G	BLUE	<table border="1"> <tr><td></td><td>54</td><td>53</td><td></td><td></td><td></td><td></td><td></td><td>47</td><td>46</td><td>45</td><td>43</td></tr> <tr><td></td><td>41</td><td>40</td><td>38</td><td></td><td></td><td></td><td></td><td>33</td><td>32</td><td>31</td><td>30</td></tr> <tr><td>28</td><td>27</td><td>26</td><td>25</td><td>24</td><td></td><td></td><td></td><td>20</td><td>19</td><td>18</td><td>16</td></tr> <tr><td></td><td></td><td></td><td></td><td></td><td></td><td>8</td><td></td><td></td><td></td><td></td><td>3</td></tr> <tr><td>13</td><td>12</td><td>11</td><td>10</td><td></td><td></td><td></td><td></td><td></td><td></td><td></td><td>2</td></tr> </table>		54	53						47	46	45	43		41	40	38					33	32	31	30	28	27	26	25	24				20	19	18	16							8					3	13	12	11	10								2					
	54	53						47	46	45	43																																																													
	41	40	38					33	32	31	30																																																													
28	27	26	25	24				20	19	18	16																																																													
						8					3																																																													
13	12	11	10								2																																																													
AVAILABLE	NOT APPLICABLE	34576-6953	G	0	G	BLUE	<table border="1"> <tr><td></td><td>54</td><td>53</td><td></td><td></td><td></td><td></td><td></td><td>47</td><td>46</td><td>45</td><td>43</td></tr> <tr><td></td><td>41</td><td>40</td><td>39</td><td>38</td><td></td><td></td><td></td><td>33</td><td>32</td><td>31</td><td>30</td></tr> <tr><td>28</td><td>27</td><td>26</td><td>25</td><td>24</td><td>23</td><td></td><td></td><td>20</td><td>19</td><td>18</td><td>16</td></tr> <tr><td></td><td></td><td></td><td></td><td></td><td></td><td>9</td><td>8</td><td></td><td></td><td></td><td>3</td></tr> <tr><td>13</td><td>12</td><td>11</td><td>10</td><td></td><td></td><td></td><td></td><td></td><td></td><td></td><td>2</td></tr> </table>		54	53						47	46	45	43		41	40	39	38				33	32	31	30	28	27	26	25	24	23			20	19	18	16							9	8				3	13	12	11	10								2					
	54	53						47	46	45	43																																																													
	41	40	39	38				33	32	31	30																																																													
28	27	26	25	24	23			20	19	18	16																																																													
						9	8				3																																																													
13	12	11	10								2																																																													
AVAILABLE	NOT APPLICABLE	34576-6963	G	0	G	BLUE	<table border="1"> <tr><td>56</td><td>54</td><td>53</td><td>52</td><td></td><td></td><td></td><td></td><td>47</td><td>46</td><td>45</td><td>43</td></tr> <tr><td></td><td>41</td><td>40</td><td>39</td><td>38</td><td></td><td></td><td></td><td>34</td><td>33</td><td>32</td><td>31</td></tr> <tr><td>28</td><td>27</td><td>26</td><td>25</td><td>24</td><td>23</td><td></td><td></td><td>20</td><td>19</td><td>18</td><td>16</td></tr> <tr><td></td><td></td><td></td><td></td><td></td><td></td><td>9</td><td>8</td><td></td><td></td><td></td><td>3</td></tr> <tr><td>13</td><td>12</td><td>11</td><td>10</td><td></td><td></td><td></td><td></td><td></td><td></td><td></td><td>2</td></tr> </table>	56	54	53	52					47	46	45	43		41	40	39	38				34	33	32	31	28	27	26	25	24	23			20	19	18	16							9	8				3	13	12	11	10								2					
56	54	53	52					47	46	45	43																																																													
	41	40	39	38				34	33	32	31																																																													
28	27	26	25	24	23			20	19	18	16																																																													
						9	8				3																																																													
13	12	11	10								2																																																													
AVAILABLE	NOT APPLICABLE	34576-6973	G	0	G	BLUE	<table border="1"> <tr><td>56</td><td></td><td></td><td>52</td><td>51</td><td>50</td><td></td><td></td><td></td><td></td><td></td><td>43</td></tr> <tr><td>42</td><td>41</td><td>39</td><td>38</td><td></td><td></td><td></td><td></td><td></td><td></td><td>32</td><td>31</td></tr> <tr><td>28</td><td>27</td><td>25</td><td>24</td><td>23</td><td>22</td><td>21</td><td></td><td></td><td></td><td>17</td><td>16</td></tr> <tr><td></td><td></td><td></td><td></td><td></td><td></td><td></td><td>8</td><td>6</td><td>5</td><td>4</td><td>3</td></tr> <tr><td>14</td><td></td><td></td><td>11</td><td>10</td><td></td><td></td><td></td><td></td><td></td><td></td><td>2</td></tr> </table>	56			52	51	50						43	42	41	39	38							32	31	28	27	25	24	23	22	21				17	16								8	6	5	4	3	14			11	10							2					
56			52	51	50						43																																																													
42	41	39	38							32	31																																																													
28	27	25	24	23	22	21				17	16																																																													
							8	6	5	4	3																																																													
14			11	10							2																																																													
AVAILABLE	NOT APPLICABLE	34576-6983	G	0	G	BLUE	<table border="1"> <tr><td></td><td>54</td><td>53</td><td></td><td></td><td></td><td></td><td></td><td></td><td>46</td><td>44</td><td></td></tr> <tr><td></td><td>40</td><td>39</td><td>38</td><td>37</td><td>36</td><td></td><td></td><td></td><td>32</td><td>31</td><td>30</td></tr> <tr><td></td><td></td><td>25</td><td>24</td><td>23</td><td>22</td><td>21</td><td>20</td><td>19</td><td></td><td></td><td></td></tr> <tr><td></td><td></td><td></td><td>11</td><td>10</td><td>9</td><td>8</td><td>7</td><td>6</td><td>5</td><td>4</td><td>2</td></tr> </table>		54	53							46	44			40	39	38	37	36				32	31	30			25	24	23	22	21	20	19							11	10	9	8	7	6	5	4	2																	
	54	53							46	44																																																														
	40	39	38	37	36				32	31	30																																																													
		25	24	23	22	21	20	19																																																																
			11	10	9	8	7	6	5	4	2																																																													
AVAILABLE	NOT APPLICABLE	34576-6993	G	0	G	BLUE	<table border="1"> <tr><td>56</td><td>55</td><td>54</td><td>53</td><td>52</td><td>51</td><td></td><td></td><td></td><td>47</td><td>46</td><td>45</td><td>43</td></tr> <tr><td></td><td>41</td><td>40</td><td>39</td><td>38</td><td></td><td></td><td></td><td></td><td>33</td><td>32</td><td>31</td><td>30</td></tr> <tr><td>28</td><td>27</td><td>26</td><td>25</td><td>24</td><td></td><td></td><td></td><td></td><td>20</td><td>19</td><td>18</td><td>16</td></tr> <tr><td></td><td></td><td></td><td></td><td></td><td></td><td></td><td></td><td></td><td></td><td></td><td></td><td>3</td></tr> <tr><td>13</td><td>12</td><td>11</td><td>10</td><td></td><td></td><td></td><td></td><td></td><td></td><td></td><td></td><td>2</td></tr> </table>	56	55	54	53	52	51				47	46	45	43		41	40	39	38					33	32	31	30	28	27	26	25	24					20	19	18	16													3	13	12	11	10									2
56	55	54	53	52	51				47	46	45	43																																																												
	41	40	39	38					33	32	31	30																																																												
28	27	26	25	24					20	19	18	16																																																												
												3																																																												
13	12	11	10									2																																																												

<b>ENTER DESCRIPTION</b> EC NO. UAU2013-1350 DRAWN BY TJB CHKD: TJB APPR: WKSHY 2013/02/28 DESCRIPTION	QUALITY SYMBOLS ∇=0 ∇=0 ∇=0	GENERAL TOLERANCES (UNLESS SPECIFIED) mm INCH 4 PLACES ±--- ±--- 3 PLACES ±--- ±--- 2 PLACES ±--- ±--- 1 PLACE ±--- ±--- 0 PLACE ±--- ±--- ANGULAR ±--- DRAFT WHERE APPLICABLE MUST REMAIN WITHIN DIMENSIONS	DIMENSION STYLE <b>MM ONLY</b>	SCALE <b>1:1</b>	DESIGN UNITS <b>METRIC</b>	THIRD ANGLE PROJECTION
	DRAWN BY DATE SKRAJENDRANA 2011/01/25		CHECKED BY DATE		APPROVED BY DATE	
	MATERIAL NO.		DOCUMENT NO.		SHEET NO.	
	SEE BOM TABLE		SD-34576-001		12 OF 15	

MX123  
18/49/56 CKT  
HRNS CONN ASSY  
**molex**

STATUS	GM PART #	MATERIAL #	PART/MATERIAL REVISION	WIRE DRESS OPTION	KEY OPTION	COLOR (TPA)	NUMBERS INDICATE CAVITIES OPEN FOR CIRCUITS																																																	
AVAILABLE	NOT APPLICABLE	34576-7003	G	0	G	BLUE	<table border="1"> <tr><td>56</td><td>55</td><td>54</td><td>52</td><td>51</td><td></td><td></td><td>47</td><td>46</td><td>45</td><td>43</td></tr> <tr><td>41</td><td>40</td><td>38</td><td></td><td></td><td></td><td></td><td>33</td><td>32</td><td>31</td><td>30</td><td>29</td></tr> <tr><td>28</td><td>27</td><td>26</td><td>25</td><td>24</td><td></td><td></td><td>20</td><td>19</td><td>18</td><td>16</td><td></td></tr> <tr><td>13</td><td>12</td><td>11</td><td>10</td><td>8</td><td></td><td></td><td></td><td></td><td>3</td><td>2</td><td></td></tr> </table>	56	55	54	52	51			47	46	45	43	41	40	38					33	32	31	30	29	28	27	26	25	24			20	19	18	16		13	12	11	10	8					3	2			
56	55	54	52	51			47	46	45	43																																														
41	40	38					33	32	31	30	29																																													
28	27	26	25	24			20	19	18	16																																														
13	12	11	10	8					3	2																																														
AVAILABLE	NOT APPLICABLE	34576-7013	G	0	G	BLUE	<table border="1"> <tr><td>56</td><td>55</td><td>54</td><td>53</td><td>52</td><td>51</td><td></td><td></td><td>47</td><td>46</td><td>45</td><td>43</td></tr> <tr><td>41</td><td>40</td><td>38</td><td></td><td></td><td></td><td></td><td>34</td><td>33</td><td>32</td><td>31</td><td>30</td><td>29</td></tr> <tr><td>28</td><td>27</td><td>26</td><td>25</td><td>24</td><td></td><td></td><td>20</td><td>19</td><td>18</td><td>16</td><td></td></tr> <tr><td>13</td><td>11</td><td>10</td><td></td><td></td><td>8</td><td></td><td></td><td></td><td></td><td>3</td><td>2</td></tr> </table>	56	55	54	53	52	51			47	46	45	43	41	40	38					34	33	32	31	30	29	28	27	26	25	24			20	19	18	16		13	11	10			8					3	2
56	55	54	53	52	51			47	46	45	43																																													
41	40	38					34	33	32	31	30	29																																												
28	27	26	25	24			20	19	18	16																																														
13	11	10			8					3	2																																													
AVAILABLE	NOT APPLICABLE	34576-7023	G	0	G	BLUE	<table border="1"> <tr><td>56</td><td>55</td><td>54</td><td>52</td><td>51</td><td></td><td></td><td></td><td>47</td><td>46</td><td>45</td><td>43</td></tr> <tr><td>41</td><td>40</td><td>38</td><td></td><td></td><td></td><td></td><td>34</td><td>33</td><td>32</td><td>31</td><td>30</td><td>29</td></tr> <tr><td>28</td><td>27</td><td>26</td><td>25</td><td>24</td><td></td><td></td><td>20</td><td>19</td><td>18</td><td>16</td><td></td></tr> <tr><td>13</td><td>12</td><td>11</td><td>10</td><td>8</td><td></td><td></td><td></td><td></td><td></td><td>3</td><td>2</td></tr> </table>	56	55	54	52	51				47	46	45	43	41	40	38					34	33	32	31	30	29	28	27	26	25	24			20	19	18	16		13	12	11	10	8						3	2
56	55	54	52	51				47	46	45	43																																													
41	40	38					34	33	32	31	30	29																																												
28	27	26	25	24			20	19	18	16																																														
13	12	11	10	8						3	2																																													
AVAILABLE	NOT APPLICABLE	34576-7033	G	0	G	BLUE	<table border="1"> <tr><td>56</td><td>54</td><td>53</td><td>52</td><td></td><td></td><td></td><td></td><td>47</td><td>46</td><td>45</td><td>43</td></tr> <tr><td>41</td><td>40</td><td>38</td><td></td><td></td><td></td><td></td><td>33</td><td>32</td><td>31</td><td>30</td><td>29</td></tr> <tr><td>28</td><td>27</td><td>26</td><td>25</td><td>24</td><td></td><td></td><td>20</td><td>19</td><td>18</td><td>16</td><td></td></tr> <tr><td>13</td><td>12</td><td>11</td><td>10</td><td>8</td><td></td><td></td><td></td><td></td><td></td><td>3</td><td>2</td></tr> </table>	56	54	53	52					47	46	45	43	41	40	38					33	32	31	30	29	28	27	26	25	24			20	19	18	16		13	12	11	10	8						3	2	
56	54	53	52					47	46	45	43																																													
41	40	38					33	32	31	30	29																																													
28	27	26	25	24			20	19	18	16																																														
13	12	11	10	8						3	2																																													
AVAILABLE	NOT APPLICABLE	34576-7043	G	0	G	BLUE	<table border="1"> <tr><td>56</td><td>54</td><td>52</td><td></td><td></td><td></td><td></td><td></td><td>47</td><td>46</td><td>45</td><td>43</td></tr> <tr><td>41</td><td>40</td><td>38</td><td></td><td></td><td></td><td></td><td>33</td><td>32</td><td>31</td><td>30</td><td>29</td></tr> <tr><td>28</td><td>27</td><td>26</td><td>25</td><td>24</td><td></td><td></td><td>20</td><td>19</td><td>18</td><td>16</td><td></td></tr> <tr><td>13</td><td>12</td><td>11</td><td>10</td><td>8</td><td></td><td></td><td></td><td></td><td></td><td>3</td><td>2</td></tr> </table>	56	54	52						47	46	45	43	41	40	38					33	32	31	30	29	28	27	26	25	24			20	19	18	16		13	12	11	10	8						3	2	
56	54	52						47	46	45	43																																													
41	40	38					33	32	31	30	29																																													
28	27	26	25	24			20	19	18	16																																														
13	12	11	10	8						3	2																																													
AVAILABLE	NOT APPLICABLE	34576-7053	G	0	G	BLUE	<table border="1"> <tr><td>56</td><td>54</td><td>53</td><td>52</td><td></td><td></td><td></td><td></td><td>47</td><td>46</td><td>45</td><td>43</td></tr> <tr><td>41</td><td>40</td><td>38</td><td></td><td></td><td></td><td></td><td>34</td><td>33</td><td>32</td><td>31</td><td>30</td><td>29</td></tr> <tr><td>28</td><td>27</td><td>26</td><td>25</td><td>24</td><td></td><td></td><td>20</td><td>19</td><td>18</td><td>16</td><td></td></tr> <tr><td>13</td><td>12</td><td>11</td><td>10</td><td>8</td><td></td><td></td><td></td><td></td><td></td><td>3</td><td>2</td></tr> </table>	56	54	53	52					47	46	45	43	41	40	38					34	33	32	31	30	29	28	27	26	25	24			20	19	18	16		13	12	11	10	8						3	2
56	54	53	52					47	46	45	43																																													
41	40	38					34	33	32	31	30	29																																												
28	27	26	25	24			20	19	18	16																																														
13	12	11	10	8						3	2																																													
AVAILABLE	NOT APPLICABLE	34576-7063	G	0	G	BLUE	<table border="1"> <tr><td>56</td><td>54</td><td>52</td><td></td><td></td><td></td><td></td><td></td><td>47</td><td>46</td><td>45</td><td>43</td></tr> <tr><td>41</td><td>40</td><td>38</td><td></td><td></td><td></td><td></td><td>34</td><td>33</td><td>32</td><td>31</td><td>30</td><td>29</td></tr> <tr><td>28</td><td>27</td><td>26</td><td>25</td><td>24</td><td></td><td></td><td>20</td><td>19</td><td>18</td><td>16</td><td></td></tr> <tr><td>13</td><td>12</td><td>11</td><td>10</td><td>8</td><td></td><td></td><td></td><td></td><td></td><td>3</td><td>2</td></tr> </table>	56	54	52						47	46	45	43	41	40	38					34	33	32	31	30	29	28	27	26	25	24			20	19	18	16		13	12	11	10	8						3	2
56	54	52						47	46	45	43																																													
41	40	38					34	33	32	31	30	29																																												
28	27	26	25	24			20	19	18	16																																														
13	12	11	10	8						3	2																																													
AVAILABLE	NOT APPLICABLE	34576-7073	G	0	G	BLUE	<table border="1"> <tr><td></td><td>54</td><td>53</td><td>52</td><td></td><td></td><td></td><td></td><td>47</td><td>46</td><td>45</td><td>43</td></tr> <tr><td>41</td><td>40</td><td>38</td><td></td><td></td><td></td><td></td><td></td><td>33</td><td>32</td><td>31</td><td>30</td><td>29</td></tr> <tr><td>28</td><td>27</td><td>26</td><td>25</td><td>24</td><td></td><td></td><td>20</td><td>19</td><td>18</td><td>16</td><td></td></tr> <tr><td>13</td><td>12</td><td>11</td><td>10</td><td>8</td><td></td><td></td><td></td><td></td><td></td><td>3</td><td>2</td></tr> </table>		54	53	52					47	46	45	43	41	40	38						33	32	31	30	29	28	27	26	25	24			20	19	18	16		13	12	11	10	8						3	2
	54	53	52					47	46	45	43																																													
41	40	38						33	32	31	30	29																																												
28	27	26	25	24			20	19	18	16																																														
13	12	11	10	8						3	2																																													
AVAILABLE	NOT APPLICABLE	34576-7083	G	0	G	BLUE	<table border="1"> <tr><td></td><td>54</td><td>53</td><td>52</td><td></td><td></td><td></td><td></td><td>47</td><td>46</td><td>45</td><td>43</td></tr> <tr><td>41</td><td>40</td><td>38</td><td></td><td></td><td></td><td></td><td>34</td><td>33</td><td>32</td><td>31</td><td>30</td><td>29</td></tr> <tr><td>28</td><td>27</td><td>26</td><td>25</td><td>24</td><td></td><td></td><td>20</td><td>19</td><td>18</td><td>16</td><td></td></tr> <tr><td>13</td><td>12</td><td>11</td><td>10</td><td>8</td><td></td><td></td><td></td><td></td><td></td><td>3</td><td>2</td></tr> </table>		54	53	52					47	46	45	43	41	40	38					34	33	32	31	30	29	28	27	26	25	24			20	19	18	16		13	12	11	10	8						3	2
	54	53	52					47	46	45	43																																													
41	40	38					34	33	32	31	30	29																																												
28	27	26	25	24			20	19	18	16																																														
13	12	11	10	8						3	2																																													

<b>ENTER DESCRIPTION</b> ELEC NO: UAU2013-1350 DRAWN BY: 2013/02/26 CHKD: APPR:IKOSHY REV: 2013/02/28	QUALITY SYMBOLS ∇=0 ∇=0 ∇=0	GENERAL TOLERANCES (UNLESS SPECIFIED) <table border="1"> <tr><th></th><th>mm</th><th>INCH</th></tr> <tr><td>4 PLACES</td><td>±---</td><td>±---</td></tr> <tr><td>3 PLACES</td><td>±---</td><td>±---</td></tr> <tr><td>2 PLACES</td><td>±---</td><td>±---</td></tr> <tr><td>1 PLACE</td><td>±---</td><td>±---</td></tr> <tr><td>0 PLACE</td><td>±---</td><td>±---</td></tr> </table>		mm	INCH	4 PLACES	±---	±---	3 PLACES	±---	±---	2 PLACES	±---	±---	1 PLACE	±---	±---	0 PLACE	±---	±---	DIMENSION STYLE <b>MM ONLY</b>	SCALE <b>1:1</b>	DESIGN UNITS <b>METRIC</b>	THIRD ANGLE PROJECTION
		mm	INCH																					
	4 PLACES	±---	±---																					
	3 PLACES	±---	±---																					
2 PLACES	±---	±---																						
1 PLACE	±---	±---																						
0 PLACE	±---	±---																						
DRAWN BY: SKRAJENDRANA DATE: 2011/01/25 CHECKED BY: _____ DATE: _____ APPROVED BY: _____ DATE: _____	ANGULAR ±---° DRAFT WHERE APPLICABLE MUST REMAIN WITHIN DIMENSIONS		MATERIAL NO.	DOCUMENT NO.	SHEET NO.																			
SEE BOM TABLE		SD-34576-001		13 OF 15																				
THIS DRAWING CONTAINS INFORMATION THAT IS PROPRIETARY TO MOLEX INCORPORATED AND SHOULD NOT BE USED WITHOUT WRITTEN PERMISSION																								

STATUS	GM PART #	MATERIAL #	PART/MATERIAL REVISION	WIRE DRESS OPTION	KEY OPTION ▽	COLOR (TPA) ▽	NUMBERS INDICATE CAVITIES OPEN FOR CIRCUITS ▽																																																							
AVAILABLE	NOT APPLICABLE	34576-7093	G	0	G	BLUE	<table border="1"> <tr><td></td><td>54</td><td>53</td><td></td><td></td><td></td><td></td><td>47</td><td>46</td><td>45</td><td>43</td></tr> <tr><td>41</td><td>40</td><td>38</td><td></td><td></td><td></td><td></td><td>33</td><td>32</td><td>31</td><td>30</td><td>29</td></tr> <tr><td>28</td><td>27</td><td>26</td><td>25</td><td>24</td><td></td><td></td><td>20</td><td>19</td><td>18</td><td>16</td><td></td></tr> <tr><td>13</td><td>12</td><td>11</td><td>10</td><td></td><td>8</td><td></td><td></td><td></td><td>3</td><td>2</td><td></td></tr> </table>		54	53					47	46	45	43	41	40	38					33	32	31	30	29	28	27	26	25	24			20	19	18	16		13	12	11	10		8				3	2									
	54	53					47	46	45	43																																																				
41	40	38					33	32	31	30	29																																																			
28	27	26	25	24			20	19	18	16																																																				
13	12	11	10		8				3	2																																																				
AVAILABLE	NOT APPLICABLE	34576-7103	G	0	G	BLUE	<table border="1"> <tr><td>56</td><td>55</td><td></td><td></td><td>52</td><td>51</td><td>50</td><td>49</td><td>48</td><td>47</td><td>45</td><td>43</td></tr> <tr><td>42</td><td>41</td><td></td><td></td><td></td><td></td><td></td><td>35</td><td>34</td><td>33</td><td></td><td>29</td></tr> <tr><td>28</td><td>27</td><td>26</td><td></td><td></td><td></td><td></td><td></td><td></td><td>18</td><td>17</td><td>16</td><td>15</td></tr> <tr><td>14</td><td>13</td><td>12</td><td></td><td></td><td></td><td></td><td></td><td></td><td></td><td>3</td><td>2</td><td>1</td></tr> </table>	56	55			52	51	50	49	48	47	45	43	42	41						35	34	33		29	28	27	26							18	17	16	15	14	13	12								3	2	1					
56	55			52	51	50	49	48	47	45	43																																																			
42	41						35	34	33		29																																																			
28	27	26							18	17	16	15																																																		
14	13	12								3	2	1																																																		
AVAILABLE	NOT APPLICABLE	34576-7113	G	0	G	BLUE	<table border="1"> <tr><td></td><td>54</td><td></td><td></td><td></td><td></td><td></td><td></td><td></td><td>47</td><td>46</td><td>45</td><td>43</td></tr> <tr><td>41</td><td>40</td><td></td><td>38</td><td></td><td></td><td></td><td></td><td></td><td>33</td><td>32</td><td>31</td><td>30</td><td>29</td></tr> <tr><td>28</td><td>27</td><td>26</td><td>25</td><td>24</td><td></td><td></td><td></td><td>20</td><td>19</td><td>18</td><td>16</td><td></td><td></td></tr> <tr><td>13</td><td>12</td><td>11</td><td>10</td><td></td><td>8</td><td></td><td></td><td></td><td></td><td>3</td><td>2</td><td></td><td></td></tr> </table>		54								47	46	45	43	41	40		38						33	32	31	30	29	28	27	26	25	24				20	19	18	16			13	12	11	10		8					3	2		
	54								47	46	45	43																																																		
41	40		38						33	32	31	30	29																																																	
28	27	26	25	24				20	19	18	16																																																			
13	12	11	10		8					3	2																																																			
AVAILABLE	NOT APPLICABLE	34576-7123	G	0	G	BLUE	<table border="1"> <tr><td>56</td><td>55</td><td></td><td></td><td>52</td><td>51</td><td>50</td><td>49</td><td>48</td><td>47</td><td>45</td><td>43</td></tr> <tr><td>42</td><td>41</td><td></td><td></td><td></td><td></td><td></td><td>35</td><td>34</td><td>33</td><td></td><td>29</td></tr> <tr><td>28</td><td>27</td><td>26</td><td></td><td></td><td></td><td></td><td></td><td></td><td>18</td><td>17</td><td>16</td><td>15</td></tr> <tr><td>14</td><td>13</td><td>12</td><td></td><td></td><td></td><td></td><td></td><td></td><td></td><td>3</td><td>2</td><td>1</td></tr> </table>	56	55			52	51	50	49	48	47	45	43	42	41						35	34	33		29	28	27	26							18	17	16	15	14	13	12								3	2	1					
56	55			52	51	50	49	48	47	45	43																																																			
42	41						35	34	33		29																																																			
28	27	26							18	17	16	15																																																		
14	13	12								3	2	1																																																		
AVAILABLE	NOT APPLICABLE	34576-7133	G	9	G	BLUE	<table border="1"> <tr><td>56</td><td>54</td><td>53</td><td>52</td><td></td><td></td><td></td><td></td><td></td><td>47</td><td>46</td><td>45</td><td>43</td></tr> <tr><td>41</td><td>40</td><td>39</td><td>38</td><td></td><td></td><td></td><td></td><td>34</td><td>33</td><td>32</td><td>31</td><td>30</td><td>29</td></tr> <tr><td>28</td><td>27</td><td>26</td><td>25</td><td>24</td><td>23</td><td></td><td></td><td></td><td>20</td><td>19</td><td>18</td><td>16</td><td></td></tr> <tr><td>13</td><td>12</td><td>11</td><td>10</td><td>9</td><td>8</td><td></td><td></td><td></td><td></td><td></td><td>3</td><td>2</td><td></td></tr> </table>	56	54	53	52						47	46	45	43	41	40	39	38					34	33	32	31	30	29	28	27	26	25	24	23				20	19	18	16		13	12	11	10	9	8						3	2	
56	54	53	52						47	46	45	43																																																		
41	40	39	38					34	33	32	31	30	29																																																	
28	27	26	25	24	23				20	19	18	16																																																		
13	12	11	10	9	8						3	2																																																		
AVAILABLE	NOT APPLICABLE	34576-7143	G	9	G	BLUE	<table border="1"> <tr><td>56</td><td>55</td><td>54</td><td>53</td><td>52</td><td>51</td><td></td><td></td><td></td><td>47</td><td>46</td><td>45</td><td>43</td></tr> <tr><td>41</td><td>40</td><td></td><td>38</td><td></td><td></td><td></td><td></td><td>34</td><td>33</td><td>32</td><td>31</td><td>30</td><td>29</td></tr> <tr><td>28</td><td>27</td><td>26</td><td>25</td><td>24</td><td></td><td></td><td></td><td></td><td>20</td><td>19</td><td>18</td><td>16</td><td></td></tr> <tr><td>13</td><td>12</td><td>11</td><td>10</td><td></td><td>8</td><td></td><td></td><td></td><td></td><td></td><td>3</td><td>2</td><td></td></tr> </table>	56	55	54	53	52	51				47	46	45	43	41	40		38					34	33	32	31	30	29	28	27	26	25	24					20	19	18	16		13	12	11	10		8						3	2	
56	55	54	53	52	51				47	46	45	43																																																		
41	40		38					34	33	32	31	30	29																																																	
28	27	26	25	24					20	19	18	16																																																		
13	12	11	10		8						3	2																																																		
AVAILABLE	NOT APPLICABLE	34576-7153	G	9	G	BLUE	<table border="1"> <tr><td>56</td><td>54</td><td>53</td><td>52</td><td></td><td></td><td>49</td><td>47</td><td>46</td><td>45</td><td>43</td></tr> <tr><td>41</td><td>40</td><td>39</td><td>38</td><td></td><td></td><td></td><td>34</td><td>33</td><td>32</td><td>31</td><td>30</td><td>29</td></tr> <tr><td>28</td><td>27</td><td>26</td><td>25</td><td>24</td><td>23</td><td></td><td></td><td></td><td>20</td><td>19</td><td>18</td><td>16</td><td></td></tr> <tr><td>13</td><td>12</td><td>11</td><td>10</td><td>9</td><td>8</td><td></td><td></td><td></td><td></td><td></td><td>3</td><td>2</td><td></td></tr> </table>	56	54	53	52			49	47	46	45	43	41	40	39	38				34	33	32	31	30	29	28	27	26	25	24	23				20	19	18	16		13	12	11	10	9	8						3	2				
56	54	53	52			49	47	46	45	43																																																				
41	40	39	38				34	33	32	31	30	29																																																		
28	27	26	25	24	23				20	19	18	16																																																		
13	12	11	10	9	8						3	2																																																		
AVAILABLE	NOT APPLICABLE	34576-7163	G	0	G	BLUE	<table border="1"> <tr><td></td><td></td><td></td><td>53</td><td></td><td></td><td></td><td>49</td><td>47</td><td>46</td><td>45</td><td>44</td></tr> <tr><td></td><td></td><td>40</td><td></td><td></td><td>37</td><td>36</td><td>35</td><td>33</td><td></td><td></td><td></td><td></td><td></td></tr> <tr><td></td><td></td><td>26</td><td></td><td></td><td></td><td></td><td></td><td>20</td><td>19</td><td>18</td><td></td><td></td><td></td></tr> <tr><td>13</td><td>12</td><td></td><td></td><td>9</td><td></td><td>7</td><td></td><td></td><td></td><td></td><td></td><td></td><td></td></tr> </table>				53				49	47	46	45	44			40			37	36	35	33								26						20	19	18				13	12			9		7								
			53				49	47	46	45	44																																																			
		40			37	36	35	33																																																						
		26						20	19	18																																																				
13	12			9		7																																																								
AVAILABLE	NOT APPLICABLE	34576-7173	G	9	G	BLUE	<table border="1"> <tr><td></td><td>55</td><td></td><td></td><td>52</td><td>51</td><td></td><td></td><td>48</td><td>46</td><td>45</td><td>43</td></tr> <tr><td>41</td><td>40</td><td></td><td>38</td><td></td><td></td><td></td><td></td><td></td><td>33</td><td>32</td><td>31</td><td>30</td><td>29</td></tr> <tr><td>28</td><td>26</td><td>24</td><td></td><td></td><td></td><td></td><td></td><td></td><td>20</td><td>19</td><td>18</td><td>16</td><td>15</td></tr> <tr><td>13</td><td>12</td><td></td><td>10</td><td></td><td></td><td></td><td></td><td></td><td></td><td></td><td>3</td><td>2</td><td>1</td></tr> </table>		55			52	51			48	46	45	43	41	40		38						33	32	31	30	29	28	26	24							20	19	18	16	15	13	12		10								3	2	1	
	55			52	51			48	46	45	43																																																			
41	40		38						33	32	31	30	29																																																	
28	26	24							20	19	18	16	15																																																	
13	12		10								3	2	1																																																	

<b>ENTER DESCRIPTION</b> EC NO: UAU2013-1350 DRAWN BY: CHYO APPR: IKOSHY 2013/02/28 2013/02/28 TJSB	QUALITY SYMBOLS ▽=0 ▽=0 ▽=0	GENERAL TOLERANCES (UNLESS SPECIFIED): 4 PLACES ±---+--- 3 PLACES ±---+--- 2 PLACES ±---+--- 1 PLACE ±---+--- 0 PLACE ±---+---	DIMENSION STYLE <b>MM ONLY</b>	SCALE <b>1:1</b>	DESIGN UNITS <b>METRIC</b>	THIRD ANGLE PROJECTION
	DRAWN BY: SKRA JENDRANA DATE: 2011/01/25	CHECKED BY:	DATE:	APPROVED BY:	DATE:	TITLE <b>MX123 18/49/56 CKT HRNS CONN ASSY</b>
	MATERIAL NO.	DOCUMENT NO.	SHEET NO.	SEE BOM TABLE		
	DRAFT WHERE APPLICABLE MUST REMAIN WITHIN DIMENSIONS			THIS DRAWING CONTAINS INFORMATION THAT IS PROPRIETARY TO MOLEX INCORPORATED AND SHOULD NOT BE USED WITHOUT WRITTEN PERMISSION		

20 19 18 17 16 15 14 13 12 11 10 9 8 7 6 5 4 3 2 1

M  
L  
K  
J  
I  
H  
G  
F  
E  
D  
C  
B  
A

STATUS	GM PART #	MATERIAL #	PART/MATERIAL REVISION	WIRE DRESS OPTION	KEY OPTION	COLOR (TPA)	NUMBERS INDICATE CAVITIES OPEN FOR CIRCUITS																																																						
AVAILABLE	NOT APPLICABLE	34576-7183	G	0	G	BLUE	<table border="1"> <tr><td>56</td><td>55</td><td>53</td><td></td><td>49</td><td>48</td><td>47</td><td>46</td><td>44</td><td></td></tr> <tr><td></td><td></td><td>40</td><td>39</td><td>37</td><td>36</td><td>35</td><td>34</td><td>33</td><td>31</td><td>30</td></tr> <tr><td></td><td></td><td></td><td>25</td><td>24</td><td></td><td>22</td><td>21</td><td>20</td><td>19</td><td>18</td><td>16</td><td></td></tr> <tr><td></td><td></td><td>13</td><td>12</td><td></td><td></td><td>9</td><td>7</td><td></td><td></td><td>4</td><td>2</td><td>1</td></tr> </table>	56	55	53		49	48	47	46	44				40	39	37	36	35	34	33	31	30				25	24		22	21	20	19	18	16				13	12			9	7			4	2	1							
56	55	53		49	48	47	46	44																																																					
		40	39	37	36	35	34	33	31	30																																																			
			25	24		22	21	20	19	18	16																																																		
		13	12			9	7			4	2	1																																																	
(F38) AVAILABLE	NOT APPLICABLE	34576-7193	G	9	G	BLUE	<table border="1"> <tr><td>56</td><td>54</td><td>53</td><td>52</td><td></td><td></td><td></td><td></td><td>47</td><td>46</td><td>45</td><td>43</td></tr> <tr><td></td><td>41</td><td>40</td><td>38</td><td></td><td></td><td></td><td></td><td>34</td><td>33</td><td>32</td><td>31</td><td>30</td><td>29</td></tr> <tr><td></td><td>28</td><td>27</td><td>26</td><td>24</td><td></td><td></td><td></td><td>20</td><td>19</td><td>18</td><td>16</td><td></td><td></td></tr> <tr><td></td><td></td><td>13</td><td>12</td><td>10</td><td></td><td></td><td></td><td></td><td></td><td></td><td>3</td><td>2</td><td>1</td></tr> </table>	56	54	53	52					47	46	45	43		41	40	38					34	33	32	31	30	29		28	27	26	24				20	19	18	16					13	12	10							3	2	1
56	54	53	52					47	46	45	43																																																		
	41	40	38					34	33	32	31	30	29																																																
	28	27	26	24				20	19	18	16																																																		
		13	12	10							3	2	1																																																

<b>ENTER DESCRIPTION</b> EC NO: UAU2013-1350 DRAWN BY: TJJ CHKD: J38 APPR: WKSHY 2013/02/26 2013/02/28 DESCRIPTION	<b>QUALITY SYMBOLS</b> ▽=0 ▽=0 ▽=0		<b>GENERAL TOLERANCES (UNLESS SPECIFIED)</b> <table border="1"> <tr><th></th><th>mm</th><th>INCH</th></tr> <tr><td>4 PLACES</td><td>±---</td><td>±---</td></tr> <tr><td>3 PLACES</td><td>±---</td><td>±---</td></tr> <tr><td>2 PLACES</td><td>±---</td><td>±---</td></tr> <tr><td>1 PLACE</td><td>±---</td><td>±---</td></tr> <tr><td>0 PLACE</td><td>±---</td><td>±---</td></tr> </table>			mm	INCH	4 PLACES	±---	±---	3 PLACES	±---	±---	2 PLACES	±---	±---	1 PLACE	±---	±---	0 PLACE	±---	±---	<b>DIMENSION STYLE</b> MM ONLY DRAWN BY: SKRA JENDRANA DATE: 2011/01/25 CHECKED BY: _____ DATE: _____ APPROVED BY: _____ DATE: _____		<b>SCALE</b> 1:1 <b>DESIGN UNITS</b> METRIC <b>THIRD ANGLE PROJECTION</b>		<b>TITLE</b> MX123 18/49/56 CKT HRNS CONN ASSY <b>molex</b>	
		mm	INCH																									
	4 PLACES	±---	±---																									
	3 PLACES	±---	±---																									
2 PLACES	±---	±---																										
1 PLACE	±---	±---																										
0 PLACE	±---	±---																										
<b>ANGULAR ±---</b> DRAFT WHERE APPLICABLE MUST REMAIN WITHIN DIMENSIONS			<b>MATERIAL NO.</b> 999999999		<b>DOCUMENT NO.</b> SD-34576-001		<b>SHEET NO.</b> 15 OF 15																					
<b>THIS DRAWING CONTAINS INFORMATION THAT IS PROPRIETARY TO MOLEX INCORPORATED AND SHOULD NOT BE USED WITHOUT WRITTEN PERMISSION</b>																												
<b>SIZE D</b>																												

19 18 17 16 15 14 13 12 11 10 9 8 7 6 5 4 3 2 1