

Monitoring Relays

True RMS 3-Phase, 3-Phase+N, Multifunction

Types DPC71, PPC71

CARLO GAVAZZI



DPC71



PPC71

- TRMS 3-phase over and under voltage, phase sequence, phase loss, asymmetry and tolerance monitoring relay
- Detect when all 3 phases are present and have the correct sequence
- Detect if all the 3-phase-phase or phase-neutral voltages are within the set limits
- Detect if asymmetry and tolerance are within the set value
- Separately adjustable setpoints
- Separately adjustable delay functions (0.1 to 30 s)
- Output: 2 x 5 A relay SPDT NE
- For mounting on DIN-rail in accordance with DIN/EN 50 022 (DPC71) or plug-in module (PPC71)
- 35.5 mm Euronorm housing (DPC71) or 35.5 mm plug-in module (PPC71)
- LED indication for relays, alarm and power supply ON

Product Description

3-phase or 3-phase+neutral line voltage monitoring relay for phase sequence, phase loss, asymmetry, tolerance, over and under voltage (separately adjustable set points)

with built-in time delay function. Supply ranges from 208 to 480 VAC covered by two multivoltage relays.

Ordering key

DPC 71 D M48

Housing _____
 Function _____
 Type _____
 Item number _____
 Output _____
 Power Supply _____

Type Selection

Mounting	Output	Frequency	Supply: 208 to 240 VAC	Supply: 380 to 415 VAC	Supply: 380 to 480 VAC
DIN-rail	2 x SPDT	50 - 60 Hz	DPC 71 D M23		DPC 71 D M48
Plug-in	2 x SPDT	50 - 60 Hz	PPC 71 D M23	PPC 71 D M48	

Input Specifications

Input L1, L2, L3, N	DPC71: PPC71:	Terminals L1, L2, L3, N Terminals 5, 6, 7, 11 Measure their own supply
Note: Connect the neutral only if it is intrinsically at the star centre		
Measuring ranges M23 M48	DPC71 PPC71	177 to 275 ΔVAC 323 to 550 ΔVAC 323 to 475 ΔVAC
Ranges Upper level Lower level Asymmetry Tolerance		+2 to +22% of the nominal voltage -22 to -2% of the nominal voltage 2 to 22% of the nominal voltage 2 to 22% of the nominal voltage
Note: The input voltage must not exceed the maximum rated voltage or drop below the minimum rated voltage reported above.		
Hysteresis Set points from 2 to 5% Set points from 5 to 22%		1% 2%

Output Specifications

Output Rated insulation voltage	2 x SPDT relays N.E. 250 VAC
Contact ratings (AgSnO ₂) Resistive loads Small inductive loads	μ 5 A @ 250 VAC 5 A @ 24 VDC 2.5 A @ 250 VAC 2.5 A @ 24 VDC
Mechanical life	≥ 30 x 10 ⁶ operations
Electrical life	≥ 10 ⁵ operations (at 5 A, 250 V, cos φ = 1)
Operating frequency	≤ 7200 operations/h
Dielectric strength Dielectric voltage Rated impulse withstand volt.	≥ 2 kVAC (rms) 4 kV (1.2/50 μs)



Supply Specifications

Power supply Rated operational voltage through terminals: L1, L2, L3, N (DPC71) 5, 6, 7, 11 (PPC71) M23 - Delta Voltage: DPC71 M48 - Delta Voltage: DPC71 M48 - Star Voltage: PPC71 M48 - Delta Voltage: PPC71 M48 - Star Voltage:	Overvoltage cat. III (IEC 60664, IEC 60038) 208 to 240VAC ±15%; 45 to 65Hz 380 to 480VAC ±15%; 45 to 65Hz 220 to 277VAC ±15%; 45 to 65Hz 380 to 415VAC ±15%; 45 to 65Hz 220 to 240VAC ±15%; 45 to 65Hz
Rated operational power M23 M48	6 VA @ Δ230 VAC, 50 Hz 9 VA @ Δ400 VAC, 50 Hz Supplied by L1 and L3

General Specifications

Power ON delay	1 s ± 0.5 s or 6 s ± 0.5 s
Accuracy Temperature drift Delay ON alarm Repeatability	(15 min warm-up time) ± 1000 ppm/°C ± 10% on set value ± 50 ms ± 0.5% on full-scale
Reaction time Incorrect phase sequence or total phase loss Voltage level Asymmetry level Alarm ON delay: Alarm OFF delay:	< 200 ms (input signal variation from -20% to +20% or from +20% to -20% of set value) < 200 ms (delay < 0.1 s) < 200 ms (delay < 0.1 s)

General Specifications (cont.)

Indication for Power supply ON Alarm ON Output relays ON	LED, green LED, red (flashing 2 Hz during delay time) 2 x LED, yellow
Environment Degree of protection Pollution degree Operating temperature @ Max. voltage, 50 Hz @ Max. voltage, 60 Hz Storage temperature	(EN 60529) IP 20 3 (DPC71), 2 (PPC71) -20 to +60°C, R.H. < 95% -20 to +50°C, R.H. < 95% -30 to +80°C, R.H. < 95%
Housing Dimensions Material	DPC71 PPC71 35.5 x 81 x 67.2 mm 35.5 x 81.2 x 75 mm PA66 or noryl
Weight	Approx. 220 g
Screw terminals Tightening torque	(DPC71) Max. 0.5 Nm acc. to IEC 60947
Product standard	EN 60255-6
Approvals	UL
CE Marking EMC Immunity Emissions	L.V. Directive 2006/95/EC EMC Directive 2004/108/EC According to EN 60255-26 According to EN 61000-6-2 According to EN 60255-26 According to EN 61000-6-3

Mode of Operation

Asymmetry definition.

Asymmetry is an indicator of the mains quality and it is defined as the absolute value of the maximum deviation among the mains voltages, divided by the nominal voltage of the 3-phase system. The definition changes according to the voltage reference:

- 1) in case of measuring phase-phase voltages:

$$\frac{\max |\Delta V_{PH-PH}|}{V_{\Delta NOM}} \times 100$$

- 2) in case of measuring phase-neutral voltages:

$$\frac{\max |\Delta V_{PH-N}|}{V_{\Delta NOM}} \times 100$$

Tolerance definition.

Tolerance is another indicator of the mains quality and it is defined as the absolute value of the maximum deviation of the mains voltages from the nominal voltage, divided by the nominal voltage of the 3-phase system. The definition changes according to the voltage reference:

- 1) in case of measuring phase-phase voltages:

$$\frac{\max |V_{\Delta NOM} - V_{PH-PH}|}{V_{\Delta NOM}} \times 100$$

- 2) in case of measuring phase-neutral voltages:

$$\frac{\max |V_{\Delta NOM} - V_{PH-N}|}{V_{\Delta NOM}} \times 100$$

Example: phase-neutral monitoring

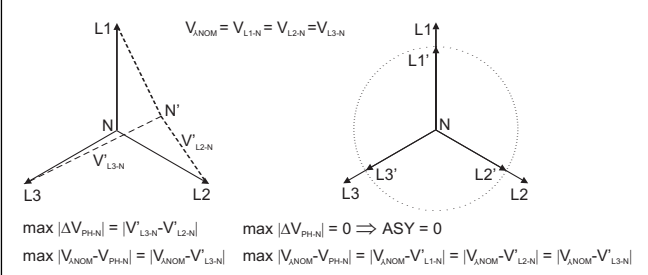

Example: phase-phase monitoring

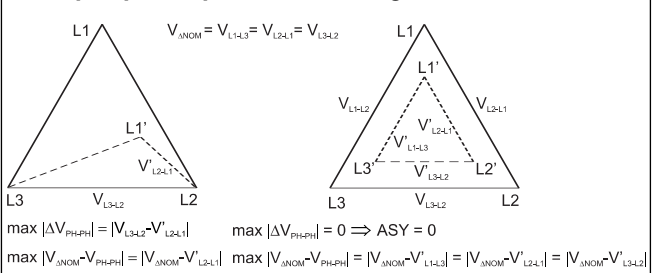

Mode of Operation (cont.)

Connected to the 3 phases (and neutral) DPC71 and PPC71 operate when all 3 phases are present at the same time and the phase sequence is correct. It can be decided whether to monitor upper and lower voltage level of each phase or their asymmetry and tolerance.

Voltage level monitoring: if one or more phase-phase or phase-neutral voltage exceed the upper set level or drop below the lower set level, the red LED starts flashing 2 Hz and the respective output relay releases after the set time period.

Asymmetry and tolerance monitoring: if one or more phase-phase or phase-neutral voltage exceed the set levels the red LED starts flashing 2 Hz and the respective output relay releases after the set time period.

Note: For both functions, if the phase sequence is wrong or one phase is lost, both output relays release immediately. Only 200 ms delay occurs. The failure is indicated by the red LED flashing 5 Hz during the alarm condition.

Example 1
(Mains monitoring - over and under phase-phase voltage)
The relay monitors over and under voltage, phase loss and correct phase sequence.

Example 2
(Motor monitoring - starting and operating load - asymmetry and tolerance of phase-neutral voltage)
DPC71 and PPC71 ensure correct starting and operating conditions. They monitor the voltage level, phase sequence (correct direction of the motor rotation) and asymmetry.

Frequent failures are fuse blowing and incorrect voltage level. In case of fuse blowing the motor regenerates a voltage in the interrupted phase. The relay detects the failure and reacts due to excessive imbalance among the phases.

Function/Range/Level/Time Setting

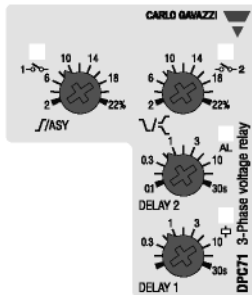

DPC71

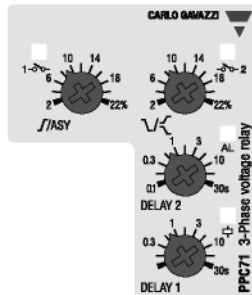

PPC71

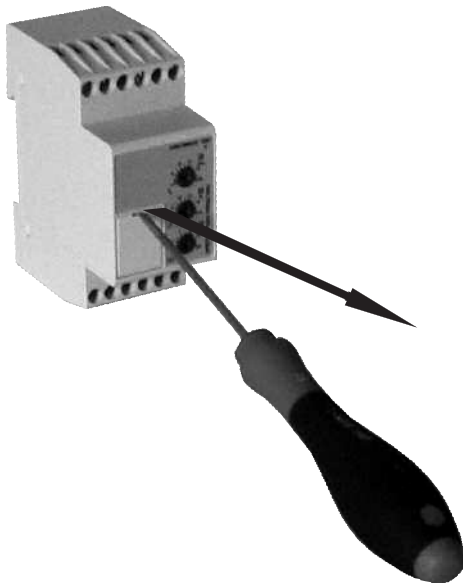

Adjust the input range setting the DIP-switches 3 and 4. Select the desired function setting the DIP-switches 5 and 6 as shown below. To access the DIP-switches open the plastic cover using a screwdriver as shown below.

Upper knobs: Setting of upper (/) and lower (\) level or setting of asymmetry (ASY) and tolerance (T) on relative scale.

Lower knobs: Setting of delay on alarm times (DELAY 1, DELAY 2) on absolute scale: 0.1 to 30s.

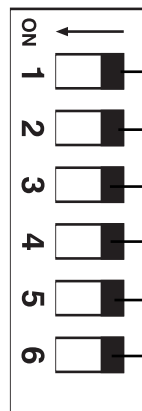

Power-ON delay
ON: 6 s ± 0.5 s
OFF: 1 s ± 0.5 s

Monitoring
ON: Phase-Neutral voltages
OFF: Phase-Phase voltages

Measuring range

SW3	ON	ON	OFF	OFF
SW4	ON	OFF	ON	OFF
M23 Ph-Ph Voltage	208 VAC	220 VAC	230 VAC	240 VAC
M48 Ph-Ph Voltage	380 VAC	400 VAC	415 VAC	480 VAC DPC71 only
M48 Ph-N Voltage	220 VAC	230 VAC	240 VAC	277 VAC DPC71 only

Output
ON: 2 x SPDT relays
OFF: 1 x DPDT relay

Function
ON: Asymmetry and tolerance monitoring
OFF: Over and undervoltage monitoring



Operation Diagrams

Over and undervoltage monitoring (2 x SPDT relays)

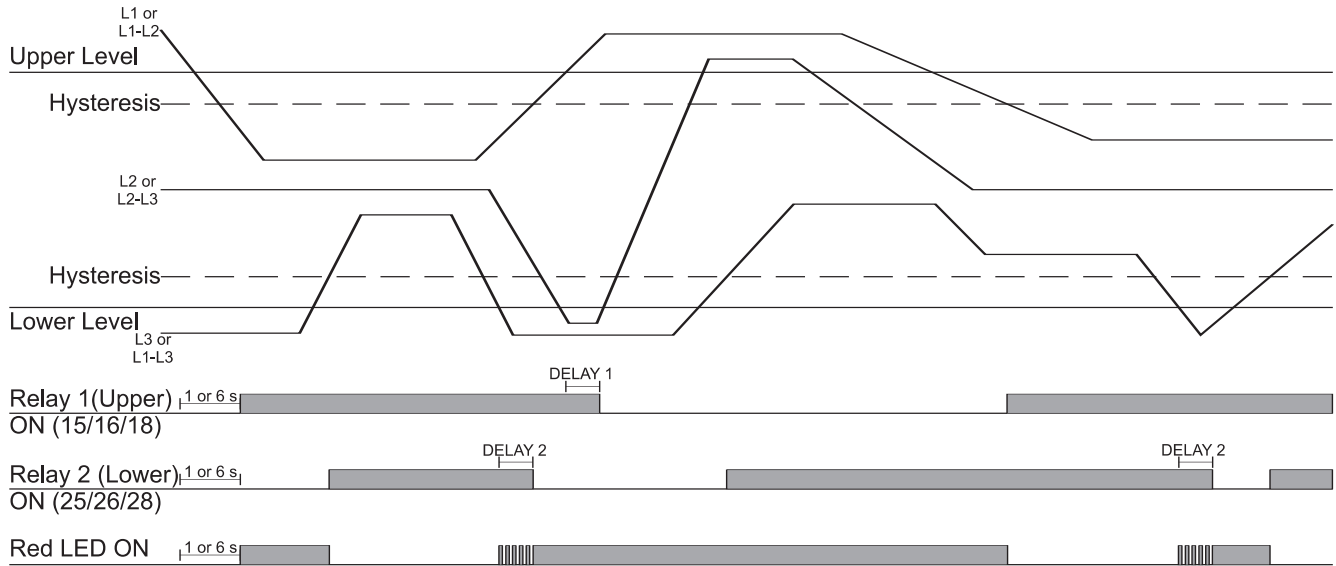

Asymmetry and tolerance monitoring (2 x SPDT relays)

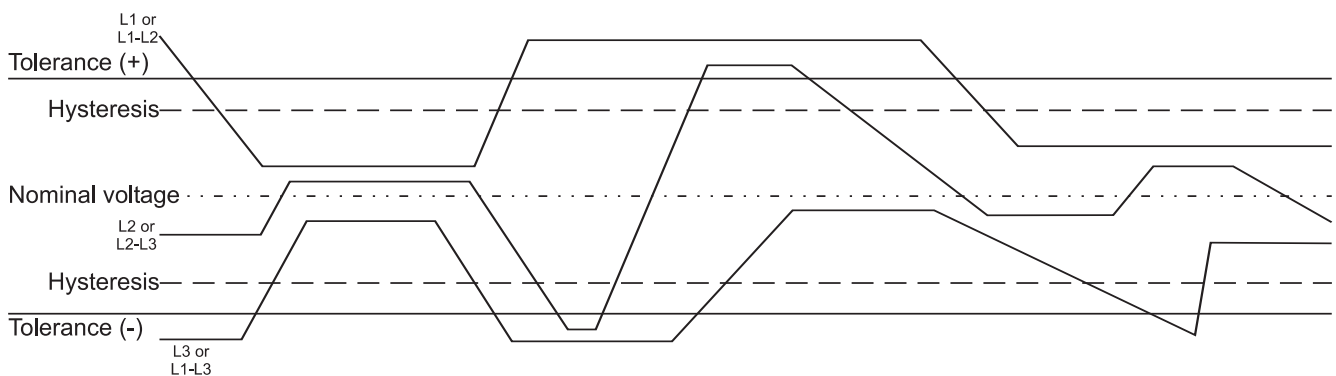
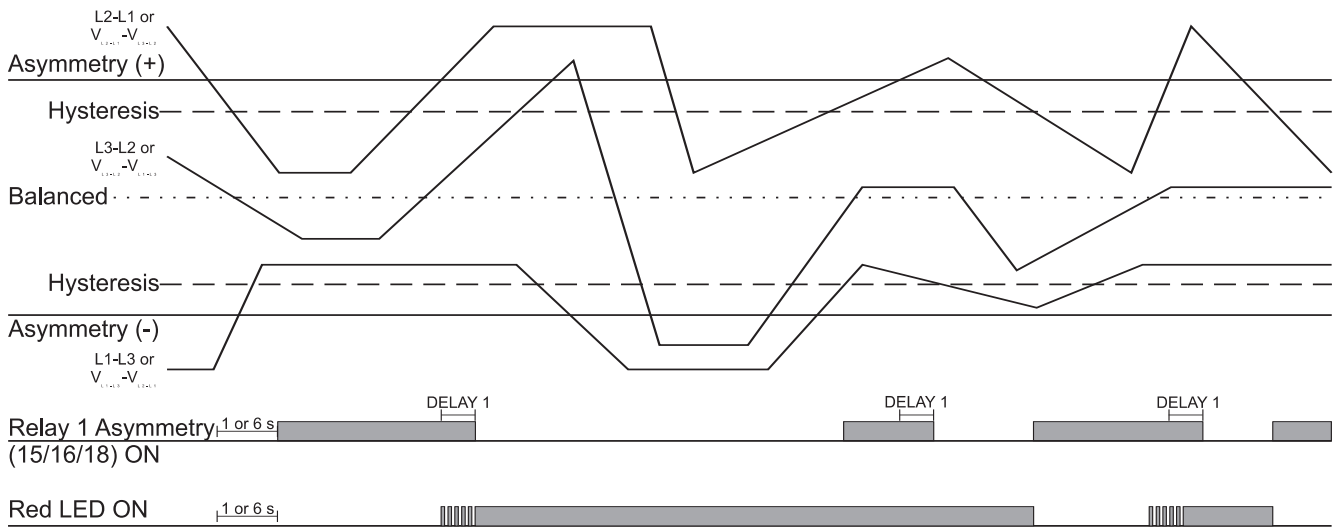

Operation Diagrams (cont.)

Phase sequence, total phase loss

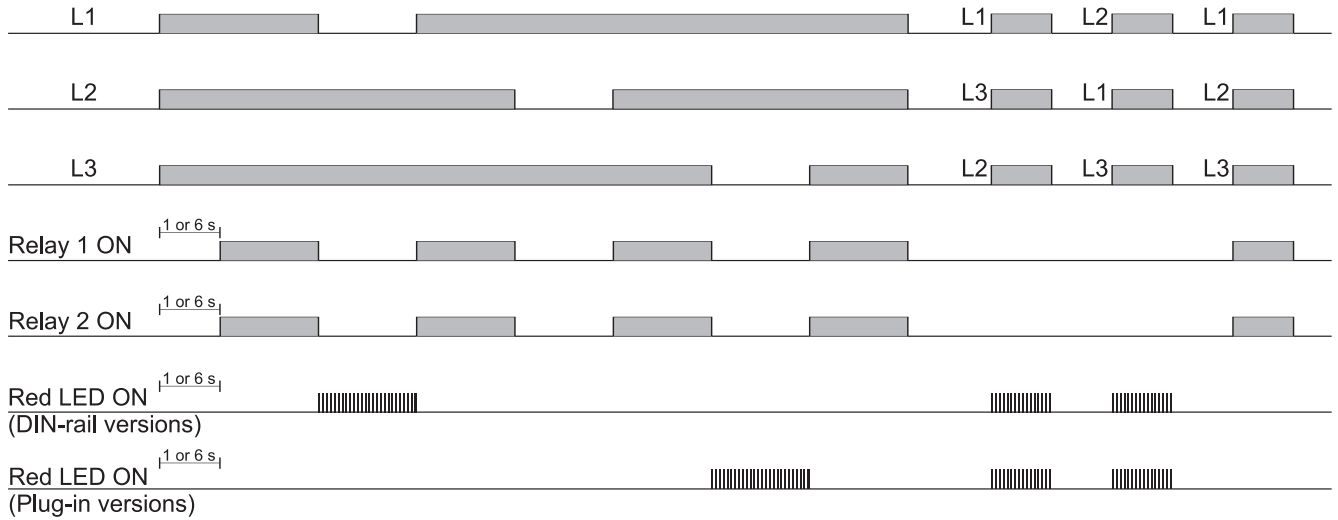

Wiring Diagrams

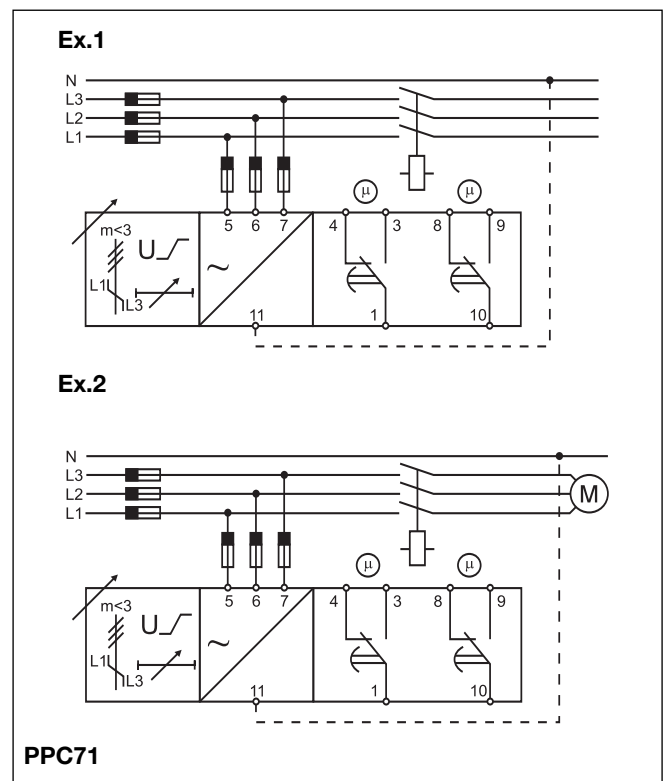
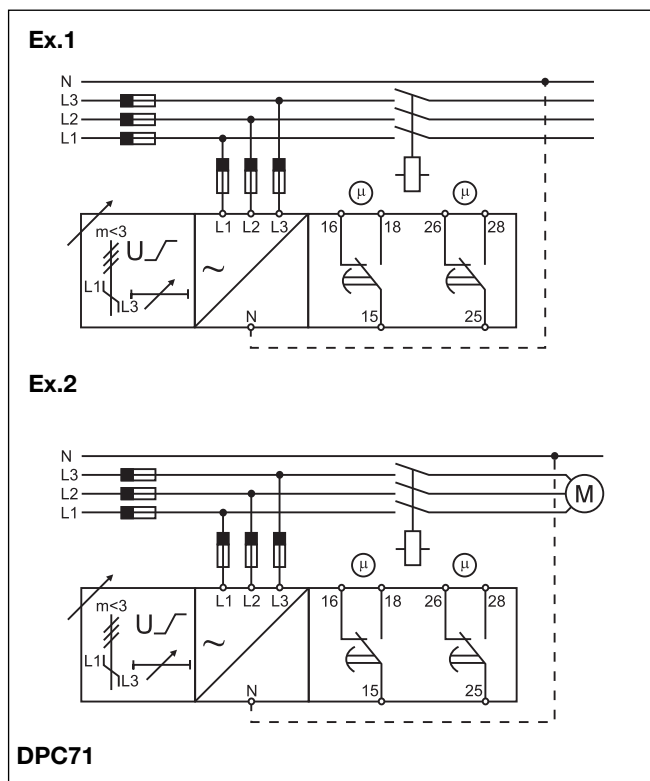

Dimensions

