

LOC	DIST	REVISIONS				
P	LTR	DESCRIPTION	DATE	DWN	APVD	
	G	REVISED PER ECR-17-003534	13MAR2017	D.S	S.Y	

- NOTE:
- MATERIAL:  
HOUSING: PA9T, UL94 V-0, COLOR: (SEE TABLE).  
CONTACTS: BRASS.
  - FINISH:  
CONTACTS: 3.05um [120u"] MIN. MATTE-TIN.  
1.27um [50u"] MIN. NICKEL UNDERPLATED ALL OVER.
  - WAVE SOLDER CAPABLE TO 265°C PER TEST SPEC.  
109-202, CONDITION B.
  - NO TE LOGO AND DATE CODE ON THE PRODUCT WITH 4 POS.
  - THE KEY IDENTIFIED WAS SHOWN ON PAGE 5.

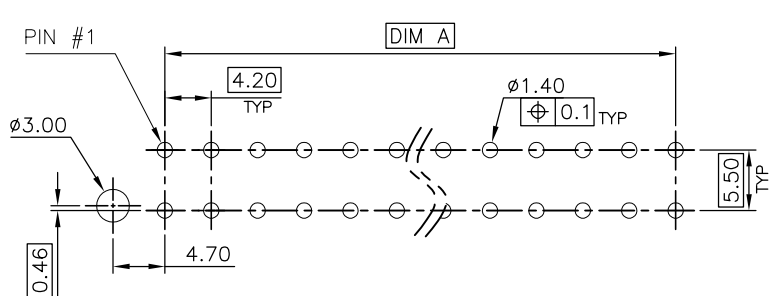

RECOMMENDED PCB LAYOUT  
 TOLERANCE: ±0.05 T=1.6mm

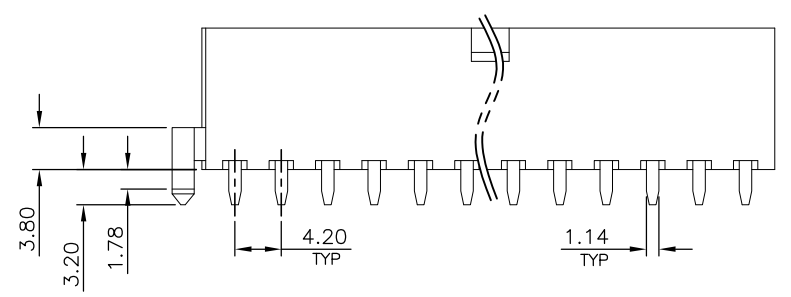
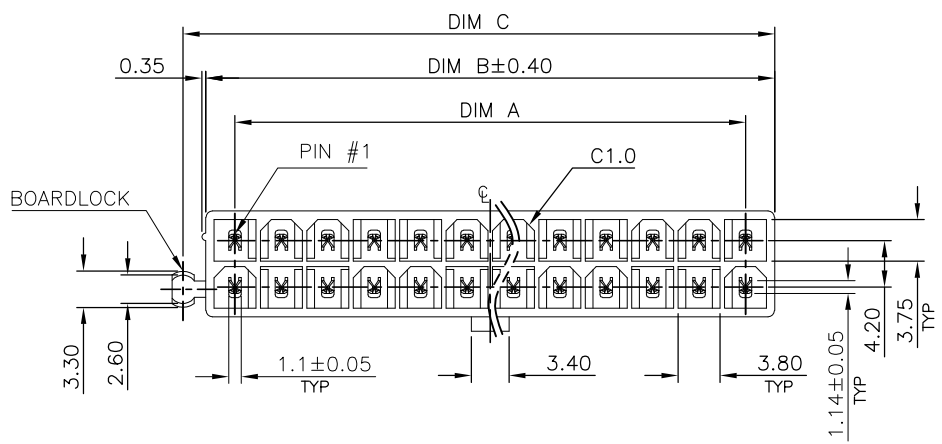
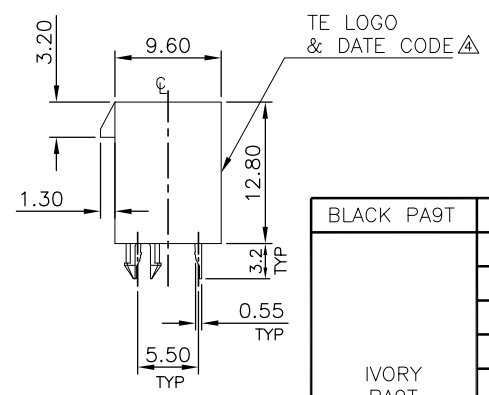

ONE BOARDLOCK  
(LEFT)

HSG COLOR & MATERIAL	WEIGHT	DIM A	DIM B	DIM C	POS.	PART NUMBER
BLACK PA9T	1.52	8.4	13.7	15.75	6	6-1775099-6
IVORY PA9T	5.40	46.2	51.5	53.55	24	1-1775099-3
	1.13	4.2	9.5	11.55	4	1-1775099-2
	4.30	37.8	43.1	45.15	20	1-1775099-1
	3.90	33.6	38.9	40.95	18	1-1775099-0
	3.11	25.2	30.5	32.55	14	1775099-9
	2.71	21.0	26.3	28.35	12	1775099-8
	2.31	16.8	22.1	24.15	10	1775099-7
	1.52	8.4	13.7	15.75	6	1775099-6
IVORY PA9T	1.92	12.6	17.9	19.95	8	1775099-5
	5.40	46.2	51.5	53.55	24	1775099-4
TRANSPARENCE PA9T	1.13	4.2	9.5	11.55	4	1775099-3
	5.40	46.2	51.5	53.55	24	1775099-2

SUPERSEDED TO 1-1775099-3  
 SUPERSEDED TO 1-1775099-2

THIS DRAWING IS A CONTROLLED DOCUMENT.		DWN B. HSING 15JUL2009	TE Connectivity ATX POWER CONNECTOR 4.2mm PITCH, VERTICAL, DIP TYPE		
DIMENSIONS: mm		CHK S. CHIEN 15JUL2009			
TOLERANCES UNLESS OTHERWISE SPECIFIED:		APVD W. KODAMA 15JUL2009	PRODUCT SPEC		
0 PLC ± - 1 PLC ± 0.3 2 PLC ± 0.2 3 PLC ± 0.15 4 PLC ± - ANGLES ± 3°		APPLICATION SPEC			108-57560
MATERIAL SEE NOTE		WEIGHT SEE TABLE			SIZE A3
FINISH SEE NOTE		CUSTOMER DRAWING			CAGE CODE 00779
		DRAWING NO C=1775099			RESTRICTED TO
		SCALE -			SHEET 1 of 6
					REV G

THIS DRAWING IS UNPUBLISHED. RELEASED FOR PUBLICATION  
 © COPYRIGHT 2010 BY TYCO ELECTRONICS CORPORATION. ALL RIGHTS RESERVED.

LOC	DIST	REVISIONS			
P	LTR	DESCRIPTION	DATE	DWN	APVD
		SEE SHEET 1.			

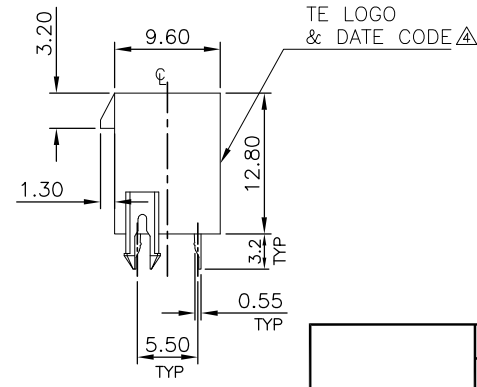
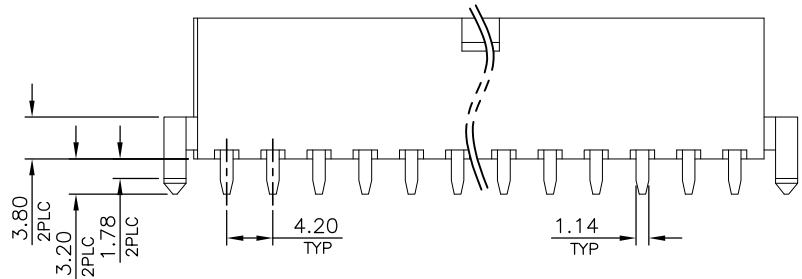
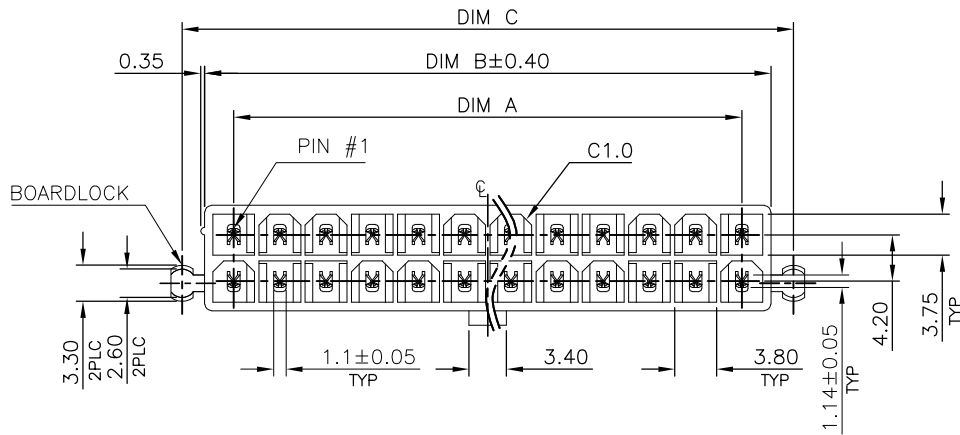

TWO BOARDLOCK

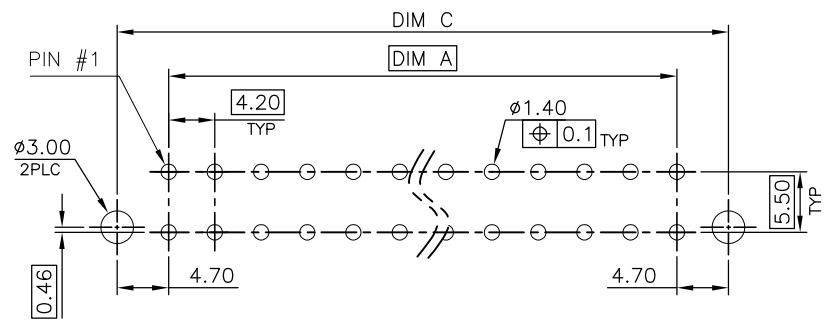

RECOMMENDED PCB LAYOUT  
 TOLERANCE: ±0.05 T=1.6mm

- NOTE:
- MATERIAL:  
HOUSING: PA9T, UL94 V-0, COLOR: (SEE TABLE).  
CONTACTS: BRASS.
  - FINISH:  
CONTACTS: 3.05um [120u"] MIN. MATTE-TIN.  
1.27um [50u"] MIN. NICKEL UNDERPLATED ALL OVER.
  - WAVE SOLDER CAPABLE TO 265°C PER TEST SPEC.  
109-202, CONDITION B.
  - NO TE LOGO AND DATE CODE ON THE PRODUCT WITH 4 POS.
  - THE KEY IDENTIFIED WAS SHOWN ON PAGE 5.

IVORY PA9T	3.54	29.4	34.7	38.8	16	2-1775099-9
	5.43	46.2	51.5	55.6	24	2-1775099-8
	4.33	37.8	43.1	47.2	20	2-1775099-7
	3.93	33.6	38.9	43.0	18	2-1775099-6
	3.14	25.2	30.5	34.6	14	2-1775099-5
	2.74	21.0	26.3	30.4	12	2-1775099-4
	2.34	16.8	22.1	26.2	10	2-1775099-3
	1.95	12.6	17.9	22.0	8	2-1775099-2
	1.55	8.4	13.7	17.8	6	2-1775099-1
	1.16	4.2	9.5	13.6	4	2-1775099-0
HSG COLOR & MATERIAL	WEIGHT	DIM A	DIM B	DIM C	POS.	PART NUMBER

THIS DRAWING IS A CONTROLLED DOCUMENT.

DIMENSIONS: mm	TOLERANCES UNLESS OTHERWISE SPECIFIED:	DWN		TE Connectivity	
	0 PLC ±	CHK	NAME		
	1 PLC ±0.3	APVD	ATX POWER CONNECTOR		
	2 PLC ±0.2	PRODUCT SPEC	4.2mm PITCH, VERTICAL, DIP TYPE		
	3 PLC ±0.15	APPLICATION SPEC	SIZE	CAGE CODE	DRAWING NO
	4 PLC ±	WEIGHT	A3	00779	C=1775099
MATERIAL	FINISH	CUSTOMER DRAWING	SCALE	SHEET	REV
	ANGLES ± 3'			2 OF 6	G

THIS DRAWING IS UNPUBLISHED. RELEASED FOR PUBLICATION  
 © COPYRIGHT 2010 BY TYCO ELECTRONICS CORPORATION. ALL RIGHTS RESERVED.

LOC		DIST		REVISIONS				
P	LTR	DESCRIPTION			DATE	DWN	APVD	
		SEE SHEET 1.						

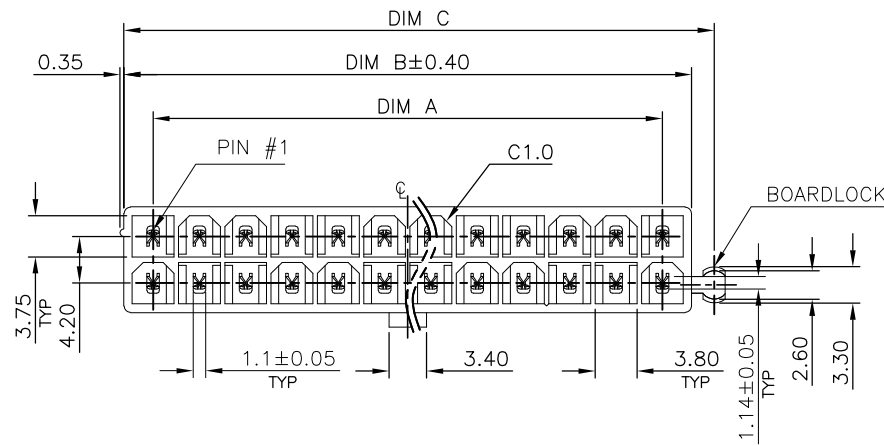

- NOTE:
- MATERIAL:  
HOUSING: PA9T, UL94 V-0, COLOR: (SEE TABLE).  
CONTACTS: BRASS.
  - FINISH:  
CONTACTS: 3.05um [120u"] MIN. MATTE-TIN.  
1.27um [50u"] MIN. NICKEL UNDERPLATED ALL OVER.
  - WAVE SOLDER CAPABLE TO 265°C PER TEST SPEC.  
109-202, CONDITION B.
  - NO TE LOGO AND DATE CODE ON THE PRODUCT WITH 4 POS.
  - THE KEY IDENTIFIED WAS SHOWN ON PAGE 5.

ONE BOARDLOCK  
(RIGHT)

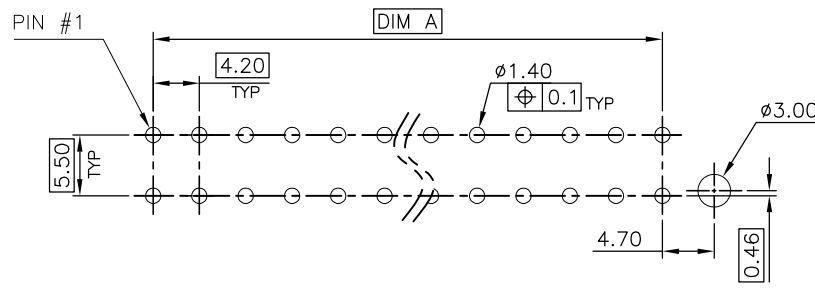
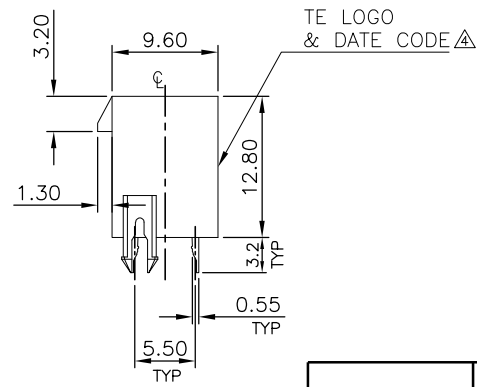
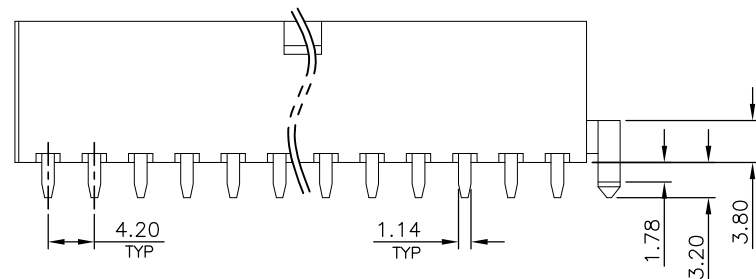

RECOMMENDED PCB LAYOUT  
TOLERANCE: ±0.05 T=1.6mm

IVORY PA9T	5.40	46.2	51.5	53.55	24	3-1775099-8
	4.30	37.8	43.1	45.15	20	3-1775099-7
	3.90	33.6	38.9	40.95	18	3-1775099-6
	3.11	25.2	30.5	32.55	14	3-1775099-5
	2.71	21.0	26.3	28.35	12	3-1775099-4
	2.31	16.8	22.1	24.15	10	3-1775099-3
	1.92	12.6	17.9	19.95	8	3-1775099-2
	1.52	8.4	13.7	15.75	6	3-1775099-1
1.13	4.2	9.5	11.55	4	3-1775099-0	
HSG COLOR & MATERIAL	WEIGHT	DIM A	DIM B	DIM C	POS.	PART NUMBER

THIS DRAWING IS A CONTROLLED DOCUMENT.

DIMENSIONS:	TOLERANCES UNLESS OTHERWISE SPECIFIED:	DWN	TE Connectivity		
mm		CHK	NAME		
	0 PLC ± -	APVD	ATX POWER CONNECTOR		
	1 PLC ± 0.3	PRODUCT SPEC	4.2mm PITCH, VERTICAL, DIP TYPE		
	2 PLC ± 0.2	APPLICATION SPEC	SIZE	CAGE CODE	DRAWING NO
	3 PLC ± 0.15	WEIGHT	A3	00779	C-1775099
	4 PLC ANGLES ± 3'	CUSTOMER DRAWING	RESTRICTED TO		
MATERIAL	FINISH	SCALE	SHEET	3 OF 6	REV G

THIS DRAWING IS UNPUBLISHED. RELEASED FOR PUBLICATION  
 © COPYRIGHT 2010 BY TYCO ELECTRONICS CORPORATION. ALL RIGHTS RESERVED.

LOC		DIST		REVISIONS				
P	LTR	DESCRIPTION			DATE	DWN	APVD	
		SEE SHEET 1.						

- NOTE:
- MATERIAL:  
HOUSING: PA9T, UL94 V-0, COLOR: (SEE TABLE).  
CONTACTS: BRASS.
  - FINISH:  
CONTACTS: 3.05um [120u"] MIN. MATTE-TIN.  
1.27um [50u"] MIN. NICKEL UNDERPLATED ALL OVER.
  - WAVE SOLDER CAPABLE TO 265°C PER TEST SPEC.  
109-202, CONDITION B.
  - NO TE LOGO AND DATE CODE ON THE PRODUCT WITH 4 POS.
  - THE KEY IDENTIFIED WAS SHOWN ON PAGE 5.

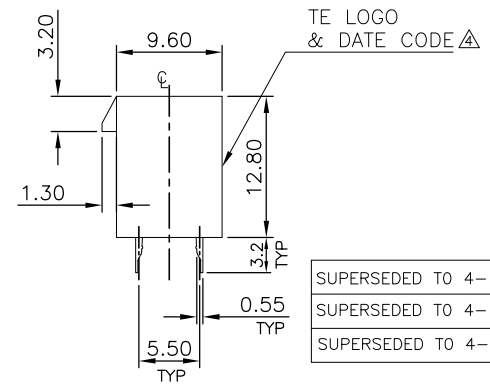
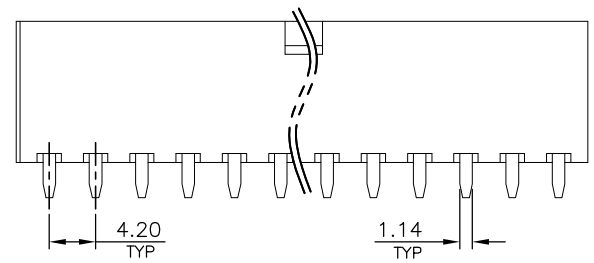
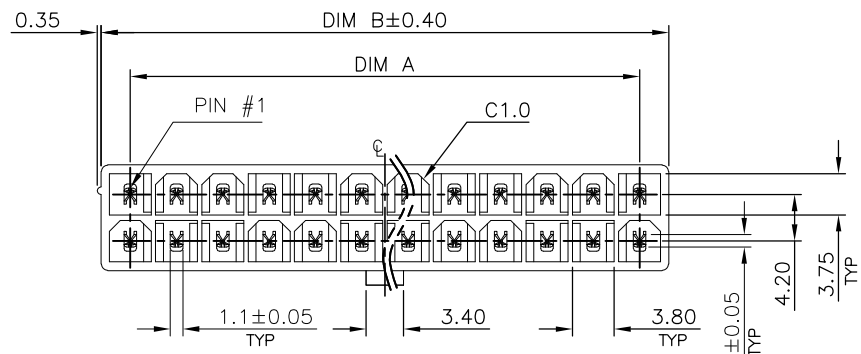

NO BOARDLOCK

SUPERSEDED TO	IVORY PA9T	2.28	16.8	22.1	10	5-1775099-3
4-1775099-3		1.89	12.6	17.9	8	5-1775099-2
4-1775099-2		1.49	8.4	13.7	6	5-1775099-1
4-1775099-1		5.37	46.2	51.5	24	4-1775099-8
		4.27	37.8	43.1	20	4-1775099-7
		3.87	33.6	38.9	18	4-1775099-6
		3.08	25.2	30.5	14	4-1775099-5
		2.68	21.0	26.3	12	4-1775099-4
		2.28	16.8	22.1	10	4-1775099-3
		1.89	12.6	17.9	8	4-1775099-2
		1.49	8.4	13.7	6	4-1775099-1
		1.10	4.2	9.5	4	4-1775099-0
	HSG COLOR & MATERIAL	WEIGHT	DIM A	DIM B	POS.	PART NUMBER

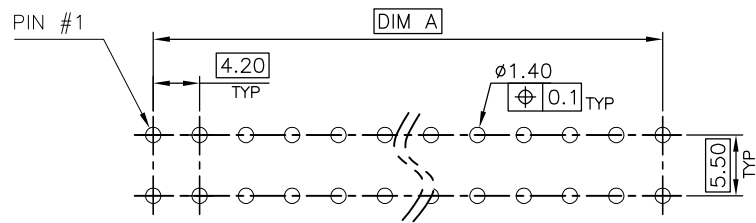

RECOMMENDED PCB LAYOUT  
 TOLERANCE: ±0.05 T=1.6mm

THIS DRAWING IS A CONTROLLED DOCUMENT.

DIMENSIONS:	TOLERANCES UNLESS OTHERWISE SPECIFIED:	DWN	TE Connectivity		
mm		CHK	NAME		
0 PLC ±	±	APVD	ATX POWER CONNECTOR		
1 PLC ±0.3	±0.3	PRODUCT SPEC	4.2mm PITCH, VERTICAL, DIP TYPE		
2 PLC ±0.2	±0.2	APPLICATION SPEC	SIZE	CAGE CODE	DRAWING NO
3 PLC ±0.15	±0.15	WEIGHT	A3	00779	C-1775099
4 PLC ANGLES ±3'	±3'	CUSTOMER DRAWING	SCALE		SHEET 4 OF 6
MATERIAL	FINISH				REV G

LOC	DIST	REVISIONS					
DW		P	LTR	DESCRIPTION	DATE	DWN	APVD
				SEE SHEET 1.			

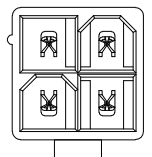

4 POS

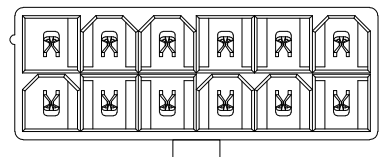

12 POS

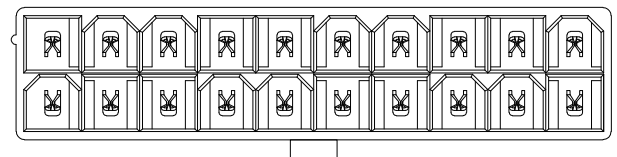

20 POS

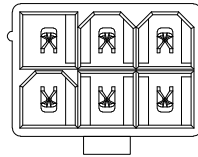

6 POS

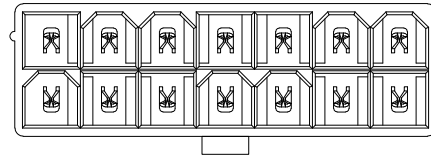

14 POS

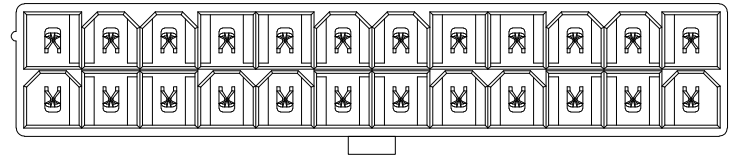

24 POS

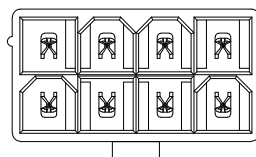

8 POS

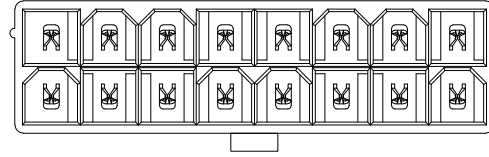

16 POS

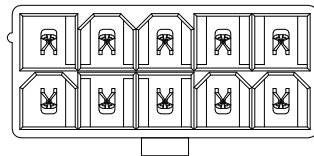

10 POS

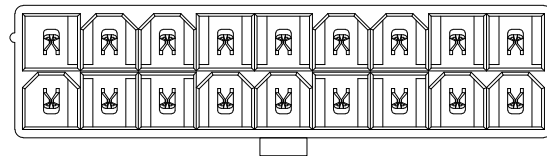

18 POS

KEY POSITION IDENTIFIED  
(TOP VIEW)

THIS DRAWING IS A CONTROLLED DOCUMENT.		DWN	TE Connectivity	
DIMENSIONS: mm		CHK	NAME	
TOLERANCES UNLESS OTHERWISE SPECIFIED:		APVD	ATX POWER CONNECTOR 4.2mm PITCH, VERTICAL, DIP TYPE	
0 PLC ± -		PRODUCT SPEC	SIZE	CAGE CODE
1 PLC ± 0.3		APPLICATION SPEC	A3	00779
2 PLC ± 0.2		WEIGHT	DRAWING NO	
3 PLC ± 0.15		CUSTOMER DRAWING	C=1775099	
4 PLC ± -		SCALE	SHEET	REV
ANGLES ± 3'			5 OF 6	G
MATERIAL	FINISH	RESTRICTED TO		

4

3

2

1

THIS DRAWING IS UNPUBLISHED. RELEASED FOR PUBLICATION  
 © COPYRIGHT 2010 BY TYCO ELECTRONICS CORPORATION. ALL RIGHTS RESERVED.

LOC		DIST		REVISIONS					
P	LTR	DESCRIPTION			DATE	DWN	APVD		
		SEE SHEET 1.							

D  
C  
B  
A

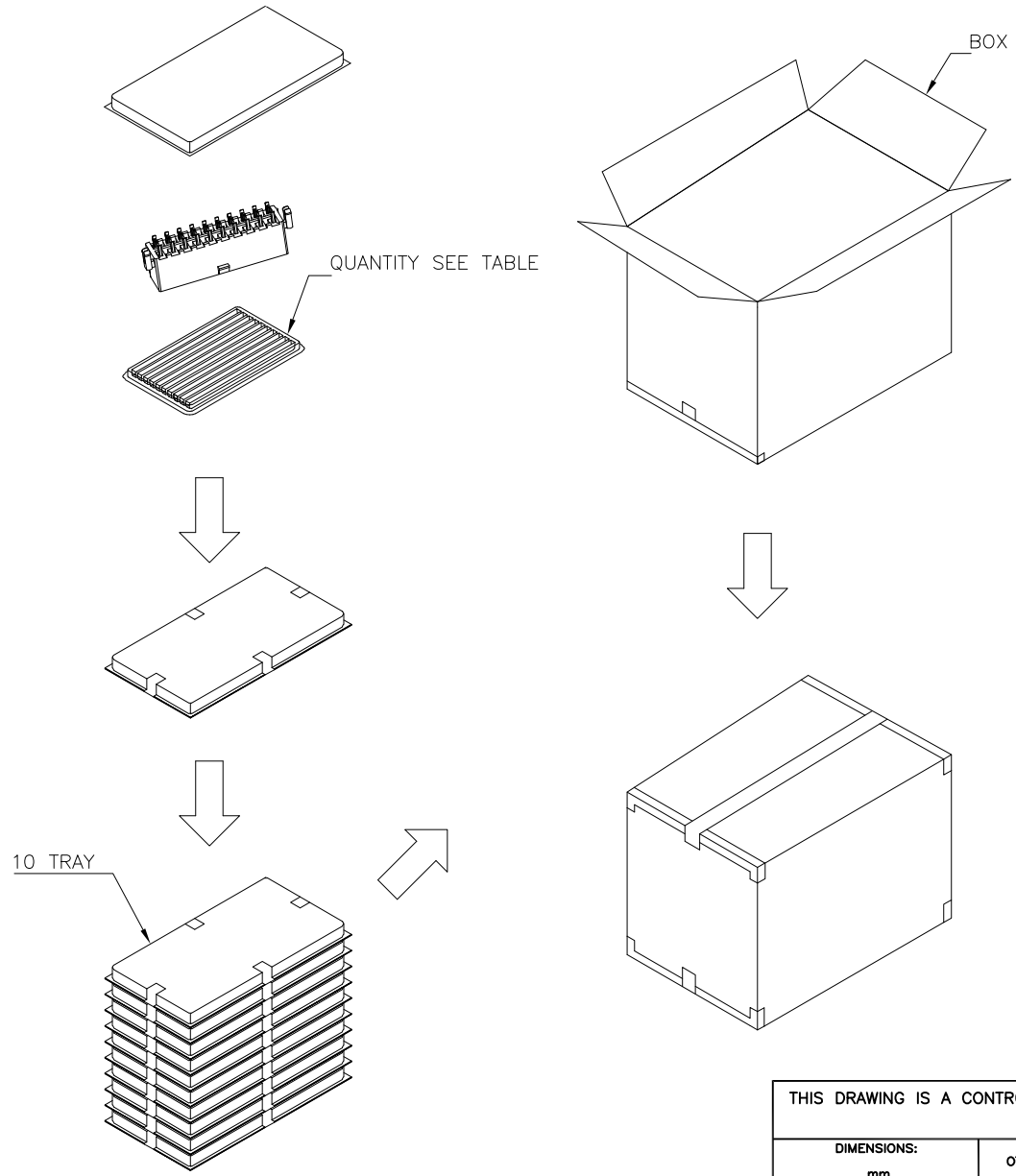

- NOTES:  
 1. TRAY : PVC, SIZE: 330mm(L)X 265mm(W)X 22mm(H).  
 2. BOX : CORRUGATED, SIZE: 350mm(L)X 279mm(W)X 195mm(H).  
 3. QUANTITY: SEE TABLE.

GROSS WEIGHT	NET WEIGHT	PCS /TRAY	TRAYS /BOX	PCS /BOX	POS.	NO. OF BOARDLOCK
5.94	4.34	80	10	800	24	2
5.93	4.33	100	10	1000	20	
5.53	3.93	100	10	1000	18	
5.85	4.25	120	10	1200	16	
6.00	4.40	140	10	1400	14	
5.98	4.38	160	10	1600	12	
5.81	4.21	180	10	1800	10	
5.89	4.29	220	10	2200	8	
5.94	4.34	280	10	2800	6	
5.78	4.18	360	10	3600	4	
5.92	4.32	80	10	800	24	1
5.90	4.30	100	10	1000	20	
6.28	4.68	120	10	1200	18	
5.95	4.35	140	10	1400	14	
5.94	4.34	160	10	1600	12	
6.22	4.62	200	10	2000	10	
6.21	4.61	240	10	2400	8	
6.16	4.56	300	10	3000	6	
6.35	4.75	420	10	4200	4	
5.90	4.30	80	10	800	24	
5.87	4.27	100	10	1000	20	
6.24	4.64	120	10	1200	18	
5.91	4.31	140	10	1400	14	
6.42	4.82	180	10	1800	12	
6.16	4.56	200	10	2000	10	
6.51	4.91	260	10	2600	8	
6.67	5.07	340	10	3400	6	
6.88	5.28	480	10	4800	4	

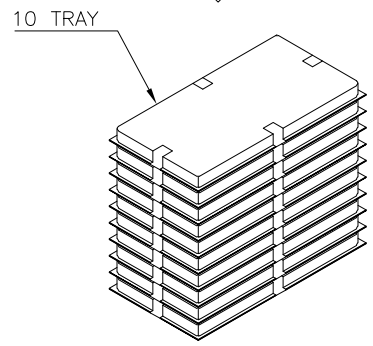

THIS DRAWING IS A CONTROLLED DOCUMENT.

DIMENSIONS: mm	TOLERANCES UNLESS OTHERWISE SPECIFIED: 0 PLC ± - 1 PLC ± 0.3 2 PLC ± 0.2 3 PLC ± 0.15 4 PLC ± - ANGLES ± 3°	DWN	TE Connectivity	
MATERIAL	FINISH	CHK	NAME	
		APVD	ATX POWER CONNECTOR 4.2mm PITCH, VERTICAL, DIP TYPE	
		PRODUCT SPEC	SIZE	RESTRICTED TO
		APPLICATION SPEC	A300779	
		WEIGHT	C=1775099	
		CUSTOMER DRAWING	SCALE	SHEET 6 OF 6
				REV G