

POWER SCHOTTKY RECTIFIER

MAIN PRODUCT CHARACTERISTICS

$I_{F(AV)}$	2 x 120 A
V_{RRM}	45 V
V_F (max)	0.67 V

FEATURES AND BENEFITS

- VERY SMALL CONDUCTION LOSSES
- NEGLIGIBLE SWITCHING LOSSES
- EXTREMELY FAST SWITCHING
- LOW THERMAL RESISTANCE
- INSULATED PACKAGE:
Insulating voltage = 2500 V_(RMS)
Capacitance = 45pF
- AVALANCHE CAPABILITY SPECIFIED

DESCRIPTION

Dual power Schottky rectifier suited for Switched Mode Power Supplies and high frequency DC to DC converters.

Packaged in ISOTOP, this device is especially intended for use in low voltage, high frequency inverters, free wheeling and polarity protection applications.

ABSOLUTE RATINGS (limiting values, per diode)

Symbol	Parameter		Value	Unit
V_{RRM}	Repetitive peak reverse voltage		45	V
$I_{F(RMS)}$	RMS forward current		170	A
$I_{F(AV)}$	Average forward current	$T_c = 80^\circ\text{C}$ $\delta = 0.5$	Per diode 240	A
I_{FSM}	Surge non repetitive forward current	$t_p = 10$ ms Sinusoidal	1500	A
I_{RRM}	Repetitive peak reverse current	$t_p = 2$ μs $F = 1$ kHz square	2	A
I_{RSM}	Non repetitive peak reverse current	$t_p = 100$ μs square	10	A
P_{ARM}	Repetitive peak avalanche power	$t_p = 1$ μs $T_j = 25^\circ\text{C}$	43000	W
T_{stg}	Storage temperature range		- 55 to + 150	$^\circ\text{C}$
T_j	Maximum operating junction temperature		150	$^\circ\text{C}$
dV/dt	Critical rate of rise of reverse voltage		10000	V/ μs

* : $\frac{dP_{tot}}{dT_j} < \frac{1}{R_{th}(j-a)}$ thermal runaway condition for a diode on its own heatsink

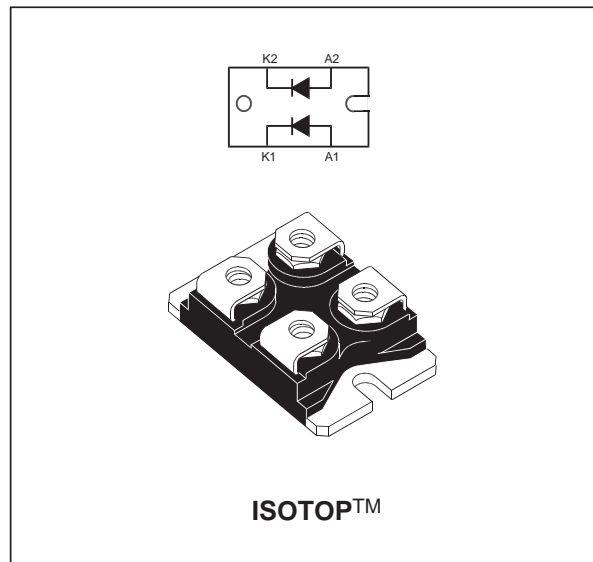

ISOTOP is a trademark of STMicroelectronics

STPS24045TV

THERMAL RESISTANCES

Symbol	Parameter		Value	Unit
$R_{th(j-c)}$	Junction to case	Per diode	0.65	$^{\circ}\text{C}/\text{W}$
		Total	0.28	
$R_{th(c)}$		Coupling	0.10	

When the diodes 1 and 2 are used simultaneously :

$$\Delta T_j(\text{diode 1}) = P(\text{diode 1}) \times R_{th(j-c)} + P(\text{diode 2}) \times R_{th(c)}$$

STATIC ELECTRICAL CHARACTERISTICS (per diode)

Symbol	Parameter	Tests Conditions		Min.	Typ.	Max.	Unit
I_R^*	Reverse leakage current	$T_j = 25^{\circ}\text{C}$	$V_R = V_{RRM}$			2	mA
		$T_j = 125^{\circ}\text{C}$				300	
V_F^*	Forward voltage drop	$T_j = 25^{\circ}\text{C}$	$I_F = 240\text{ A}$			0.91	V
		$T_j = 125^{\circ}\text{C}$	$I_F = 240\text{ A}$		0.72	0.87	
		$T_j = 125^{\circ}\text{C}$	$I_F = 120\text{ A}$		0.52	0.67	

Pulse test : * $t_p = 5\text{ ms}$, $\delta < 2\%$

** $t_p = 380\text{ }\mu\text{s}$, $\delta < 2\%$

To evaluate the conduction losses use the following equation :

$$P = 0.47 \times I_{F(AV)} + 0.00167 \times I_{F(RMS)}^2$$

Fig. 1: Average forward power dissipation versus average forward current (per diode).

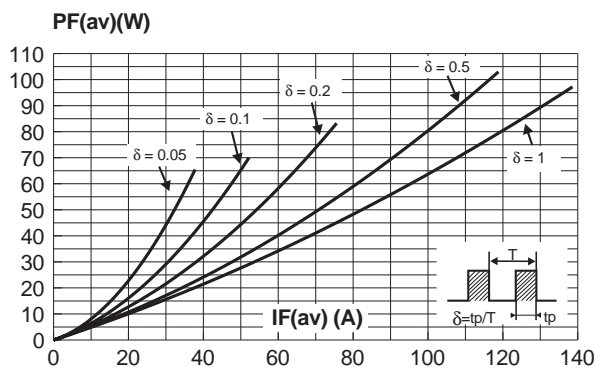

Fig. 3: Normalized avalanche power derating versus pulse duration.

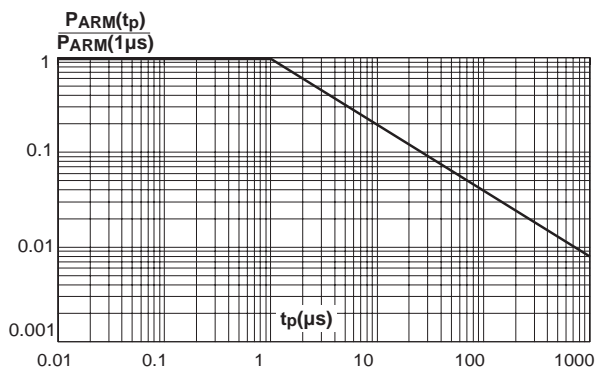

Fig. 2: Average forward current versus ambient temperature ($\delta = 0.5$, per diode).

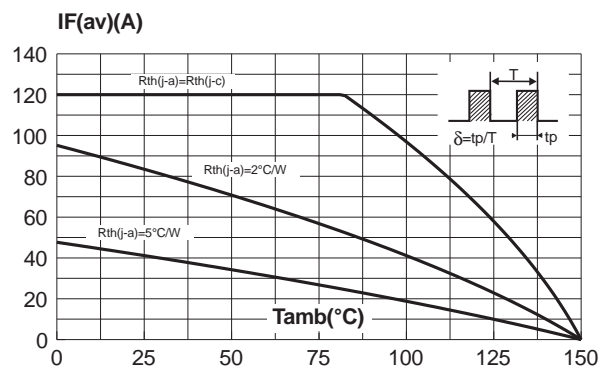

Fig. 4: Normalized avalanche power derating versus junction temperature.

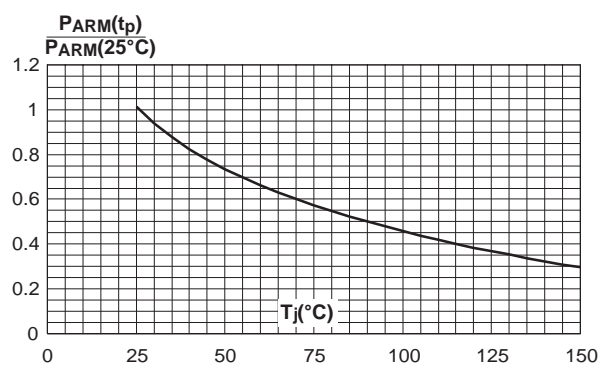

Fig. 5: Non repetitive surge peak forward current versus overload duration (maximum values, per diode).

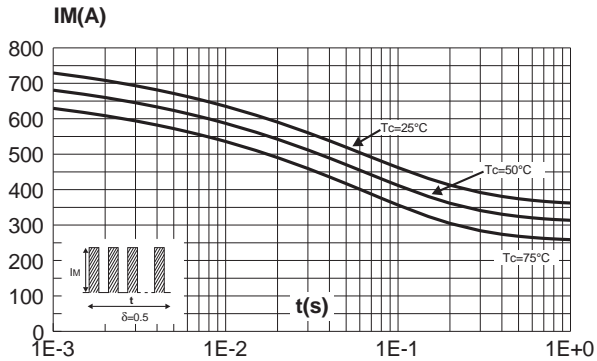

Fig. 6: Relative variation of thermal impedance junction to case versus pulse duration (per diode).

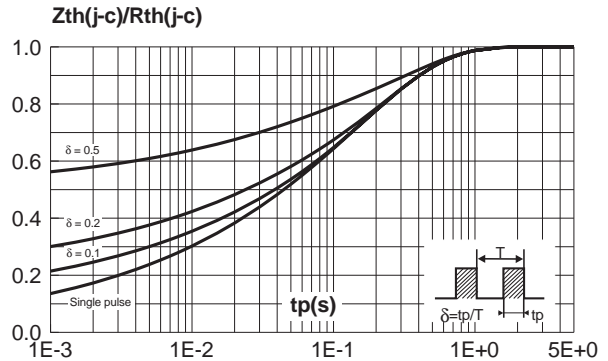

Fig. 7: Reverse leakage current versus reverse voltage applied (typical values, per diode).

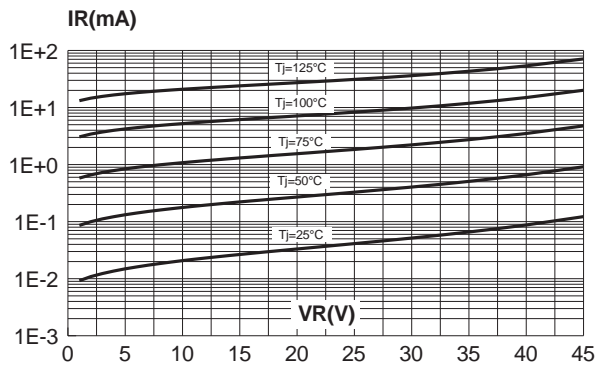

Fig. 8: Junction capacitance versus reverse voltage applied (typical values, per diode).

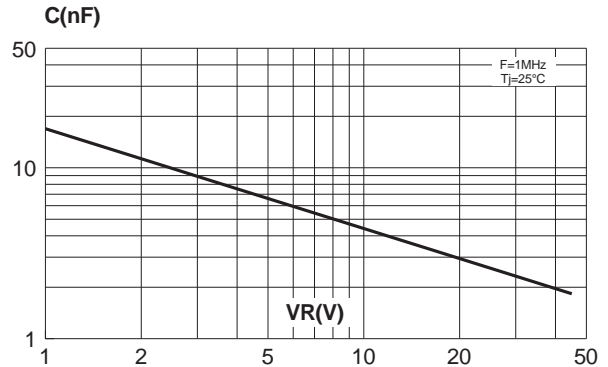
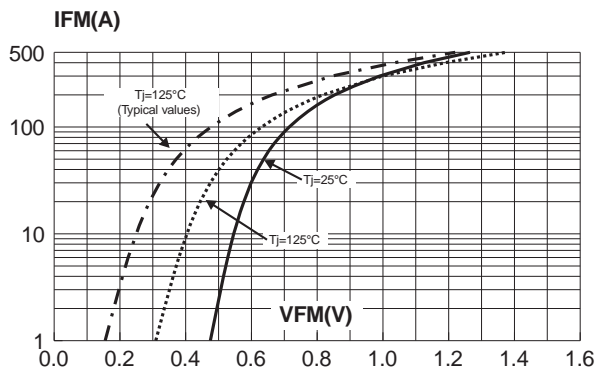
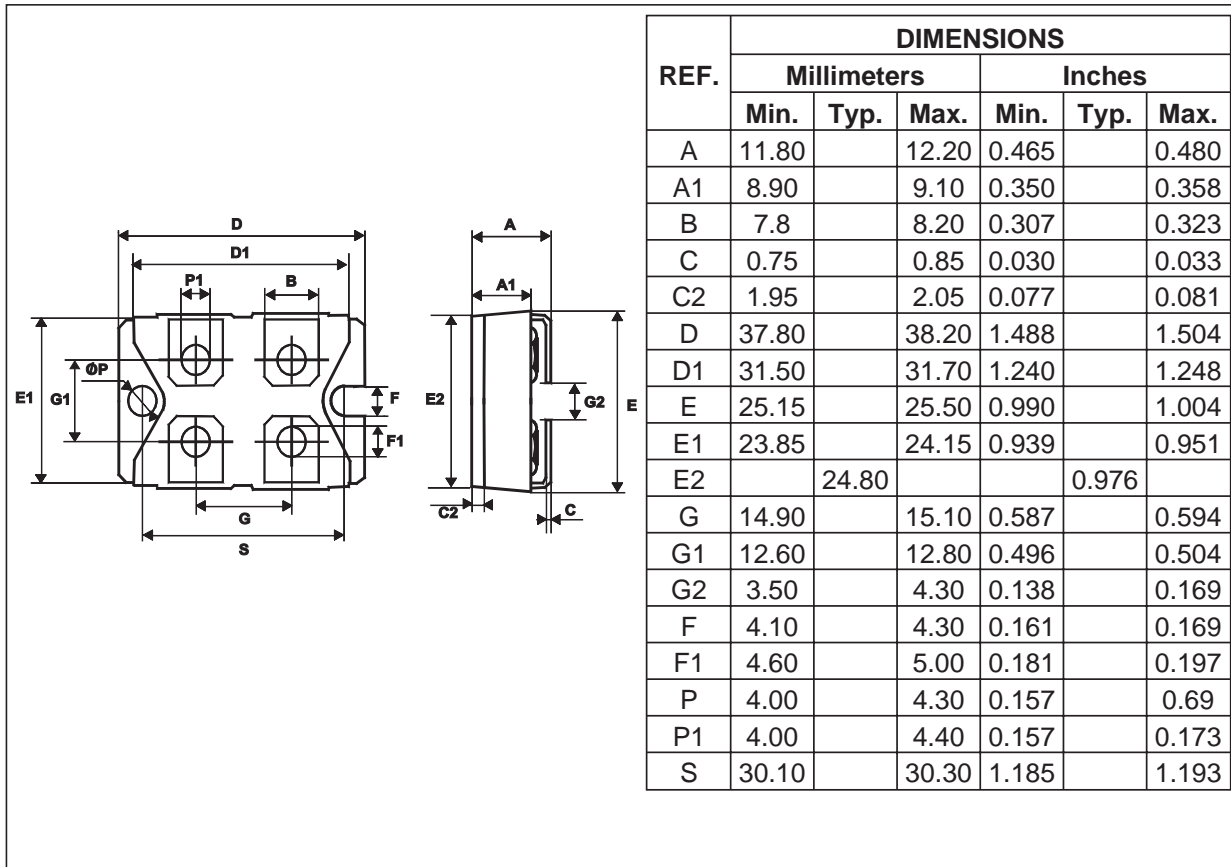

Fig. 9: Forward voltage drop versus forward current (maximum values, per diode).



STPS24045TV

PACKAGE MECHANICAL DATA ISOTOP



Type	Marking	Package	Weight	Base qty	Delivery mode
STPS24045TV	STPS24045TV	ISOTOP	28 g. (without screws)	10	Tube

- Cooling method: by conduction (C)
- Recommended torque value: 1.3 N.m
- Maximum torque value: 1.5 N.m

Information furnished is believed to be accurate and reliable. However, STMicroelectronics assumes no responsibility for the consequences of use of such information nor for any infringement of patents or other rights of third parties which may result from its use. No license is granted by implication or otherwise under any patent or patent rights of STMicroelectronics. Specifications mentioned in this publication are subject to change without notice. This publication supersedes and replaces all information previously supplied. STMicroelectronics products are not authorized for use as critical components in life support devices or systems without express written approval of STMicroelectronics.

The ST logo is a registered trademark of STMicroelectronics
 © 2003 STMicroelectronics - Printed in Italy - All rights reserved.
 STMicroelectronics GROUP OF COMPANIES
 Australia - Brazil - Canada - China - Finland - France - Germany
 Hong Kong - India - Israel - Italy - Japan - Malaysia - Malta - Morocco - Singapore
 Spain - Sweden - Switzerland - United Kingdom - United States.

<http://www.st.com>

