

Darlington

2SD2017

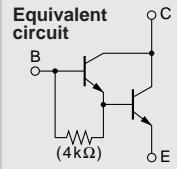

Silicon NPN Triple Diffused Planar Transistor

Application : Driver for Solenoid, Relay and Motor and General Purpose

Absolute maximum ratings (Ta=25°C)

Symbol	Ratings	Unit
V _{CB0}	300	V
V _{CEO}	250	V
V _{EB0}	20	V
I _C	6	A
I _B	1	A
P _C	35(T _C =25°C)	W
T _J	150	°C
T _{stg}	-55 to +150	°C

Electrical Characteristics (Ta=25°C)

Symbol	Conditions	Ratings	Unit
I _{CB0}	V _{CB} =300V	100max	μA
I _{EB0}	V _{EB} =20V	10max	mA
V _{(BR)CEO}	I _C =25mA	250min	V
h _{FE}	V _{CE} =2V, I _C =2A	2000min	
V _{CE(sat)}	I _C =2A, I _B =2mA	1.5max	V
V _{BE(sat)}	I _C =2A, I _B =2mA	2.0max	V
f _T	V _{CE} =12V, I _E =-1A	20typ	MHz
COB	V _{CB} =10V, f=1MHz	65typ	pF

External Dimensions FM20(TO220F)

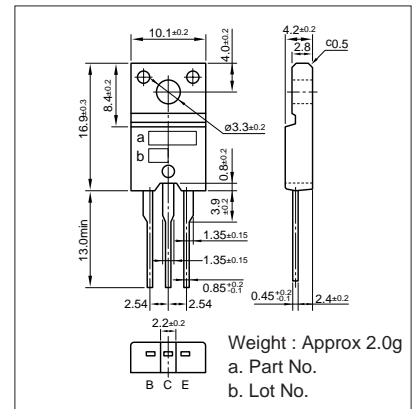

Typical Switching Characteristics (Common Emitter)

V _{CC} (V)	R _L (Ω)	I _C (A)	V _{BB1} (V)	V _{BB2} (V)	I _{B1} (mA)	I _{B2} (mA)	t _{on} (μs)	t _{stg} (μs)	t _f (μs)
100	50	2	10	-5	5	-10	0.6typ	16.0typ	3.0typ

I_C-V_{CE} Characteristics (Typical)

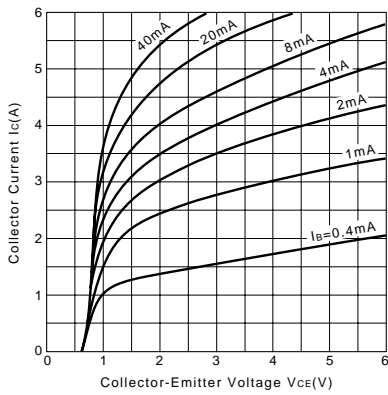

V_{CE(sat)}-I_B Characteristics (Typical)

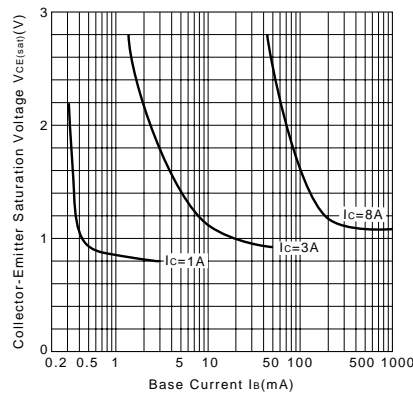

I_C-V_{BE} Temperature Characteristics (Typical)

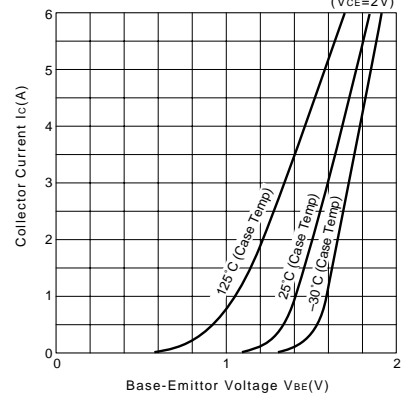

h_{FE}-I_C Characteristics (Typical)

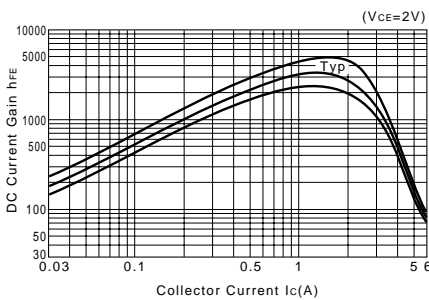

h_{FE}-I_C Temperature Characteristics (Typical)

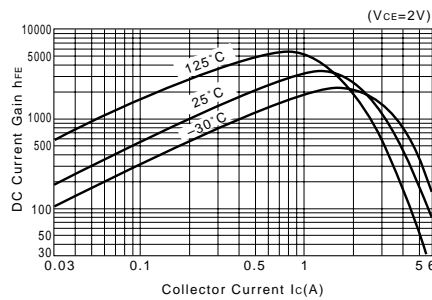

θ_{j-a-t} Characteristics

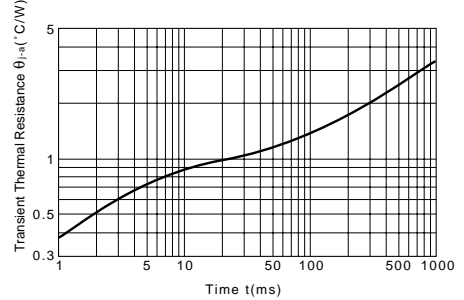

f_T-I_E Characteristics (Typical)

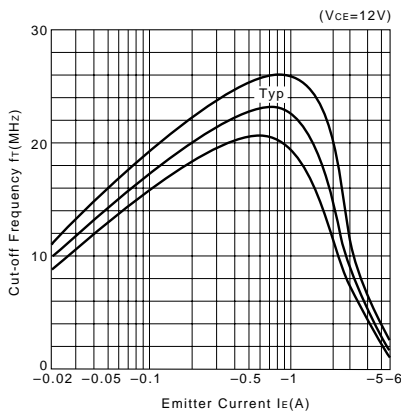

Safe Operating Area (Single Pulse)

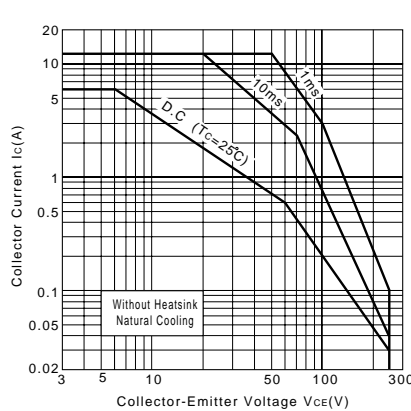

P_C-T_a Derating

