

# PQ070VK01FZH

# PQ070VK02FZH

Variable Output, Low Power-Loss Voltage Regulators with Output ON/OFF Control Function

## ■ Features

- 1.Low voltage operation (Minimum operating voltage: 2.35V)
- 2.Low power-loss(Dropout voltage : MAX.0.5V)
- 3.Compact resin mold package (Equivalent to TO-220)
- 4.Built-in ON/OFF control function
- 5.Variable output voltage type (1.5V to 7V)
- 6.Reference Voltage precision:  $\pm 2\%$
- 7.Built-in overcurrent and overheat protection functions
- 8.RoHS directive compliant

## ■ Applications

- 1.Power supplies for various electronic equipment such as AV, OA equipment

## ■ Absolute Maximum Ratings

(Ta=25°C)

Parameter	Symbol	Rating	Unit
*1 Input voltage	V <sub>IN</sub>	10	V
*1 Output control voltage	V <sub>C</sub>	10	V
*1 Output adjustment terminal voltage	V <sub>ADJ</sub>	5	V
Output current	PQ070VK01FZH	1	A
	PQ070VK02FZH	2	
*2 Power dissipation (With infinite heat sink)	P <sub>D1</sub>	1.4	W
	P <sub>D2</sub>	15	
*3 Junction temperature	T <sub>j</sub>	150	°C
Operating temperature	T <sub>opr</sub>	-40 to +85	°C
Storage temperature	T <sub>stg</sub>	-40 to +150	°C
Soldering temperature	T <sub>sol</sub>	260(10s)	°C

- \*1 All are open except GND and applicable terminals.  
 \*2 PD1: No heat sink, PD2: With infinite heat sink  
 \*3 Overheat protection may operate at T<sub>j</sub>:125°C to 150°C

## ■ Outline Dimensions

(Unit : mm)

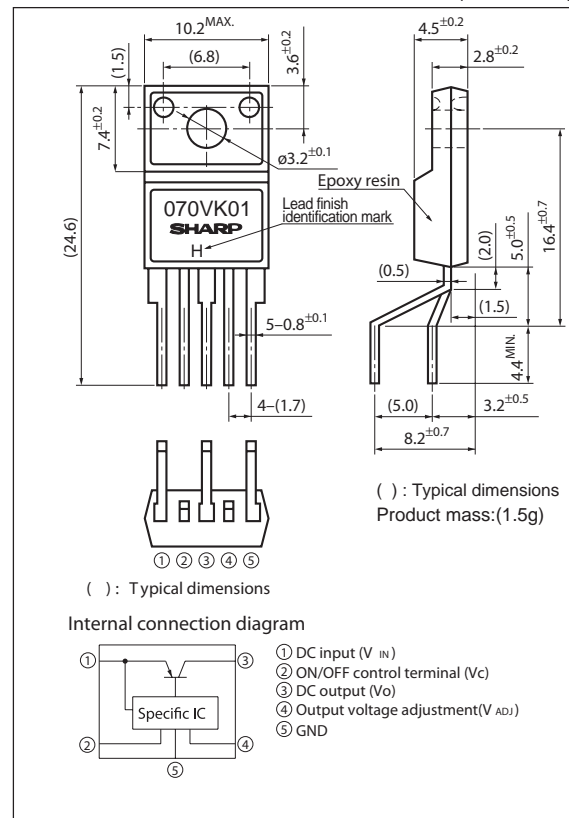

Lead finish:Lead-free solder plating  
 (Composition: Sn2Cu)

Notice The content of data sheet is subject to change without prior notice.

In the absence of confirmation by device specification sheets, SHARP takes no responsibility for any defects that may occur in equipment using any SHARP devices shown in catalogs, data books, etc. Contact SHARP in order to obtain the latest device specification sheets before using any SHARP device.

## Electrical Characteristics

(Unless otherwise specified,  $V_{IN}=5V$ ,  $V_O=3.0V$ ,<sup>\*4</sup>,  $R_1=1k\Omega$ ,  $V_C=2.7V$ ,  $T_a=25^\circ C$ )

Parameter	Symbol	Conditions	MIN.	TYP.	MAX.	Unit
Input voltage	$V_{IN}$	-	2.35	-	10	V
Output voltage	$V_O$	-	1.5	-	7	V
Load regulation	RegL	<sup>*5</sup>	-	0.2	2.0	%
Line regulation	Regl	$V_{IN}=4$ to $10V$ , $I_O=5mA$	-	0.2	1.0	%
Ripple rejection	RR	Refer to Fig.2	45	60	-	dB
Reference voltage	$V_{ref}$	-	1.225	1.25	1.275	V
Temperature coefficient of reference voltage	$T_C V_{ref}$	$T_j=0$ to $+125^\circ C$ , $I_O=5mA$	-	$\pm 1.0$	-	%
Dropout voltage	$V_{I-O}$	<sup>*4</sup> , <sup>*6</sup>	-	-	0.5	V
Quiescent current	$I_q$	$I_O=0A$	-	1	2	mA
<sup>*7</sup> ON-state voltage for control	$V_{C(ON)}$	-	2.0	-	-	V
ON-state current for control	$I_{C(ON)}$	-	-	-	200	$\mu A$
OFF-state voltage for control	$V_{C(OFF)}$	$I_O=0A$	-	-	0.8	V
OFF-state current for control	$I_{C(OFF)}$	$I_O=0A, V_C=0.4V$	-	-	2.0	$\mu A$
Output OFF-state consumption current	$I_{qs}$	$V_C=0.4V$	-	-	5.0	$\mu A$

<sup>\*4</sup> PQ070VK01FZH :  $I_O=0.5A$ , PQ070VK02FZH :  $I_O=1A$   
<sup>\*5</sup> PQ070VK01FZH :  $I_O=5mA$  to  $1A$ , PQ070VK02FZH :  $I_O=5mA$  to  $2A$   
<sup>\*6</sup>  $V_{IN}=2.85V$ , PQ070VK01FZH( $I_O=0.5A$ ), PQ070VK02FZH( $I_O=2A$ )  
<sup>\*7</sup> In case of opening ON/OFF control terminal (2), output voltage turns off.

Fig.1 Test Circuit

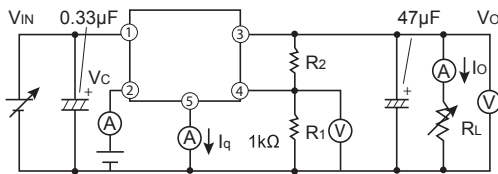

$$V_O = V_{ref} \times \left(1 + \frac{R_2}{R_1}\right)$$

[ $R_1=1k\Omega, V_{ref}$  Nearly= $1.25V$ ]

Fig.2 Test circuit of Ripple Rejection

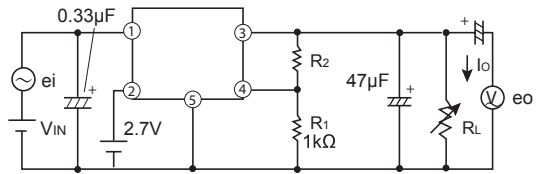

$f=120Hz$ (sine wave)  
 $e_i(rms)=0.5V$   
 $I_O=0.3A$   
 $RR=20 \log(e_i(rms)/e_o(rms))$   
 $V_{IN}=5V$   
 $V_O=3.0V(R_1=1k\Omega)$

Fig.3 Power Dissipation vs. Ambient Temperature

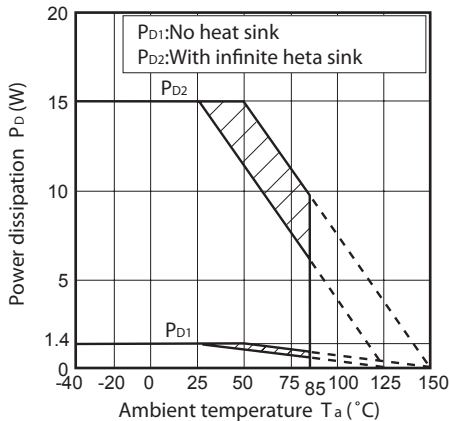

Note) Oblique line portion : Overheat protection may operate in this area.

Fig.4 Overcurrent Protection Characteristics (Typical Value) (PQ070VK01FZH)

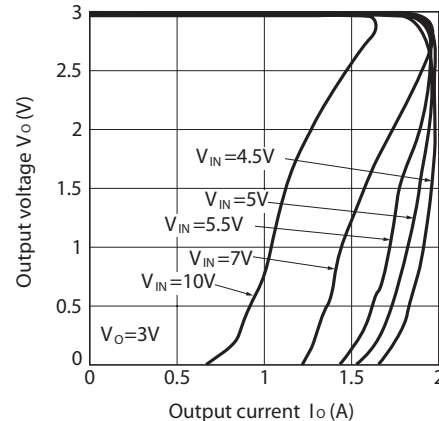

Fig.5 Reference Voltage vs. Ambient Temperature (PQ070VK01FZH)

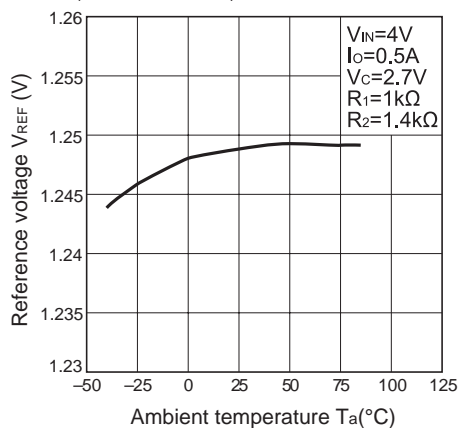

Fig.6 Output Voltage vs. Input Voltage (PQ070VK01FZH)

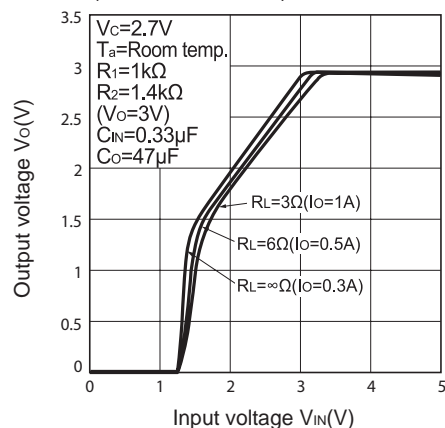

Fig.7 Circuit Operating Current vs. Input Voltage (PQ070VK01FZH)

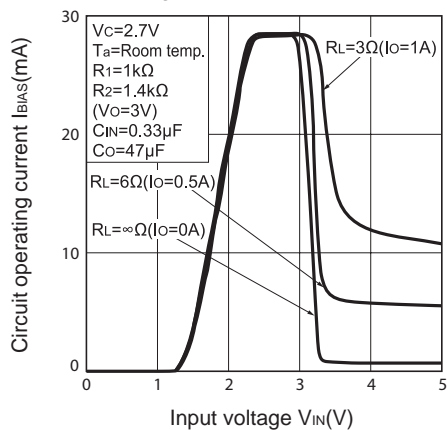

Fig.8 Dropout Voltage vs. Junction Temperature (PQ070VK01FZH)

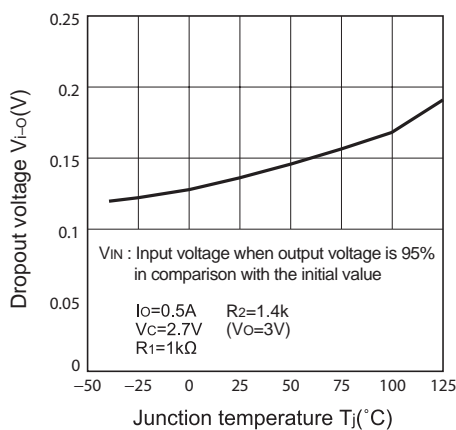

Fig.9 Quiescent Current vs. Ambient Temperature (PQ070VK01FZH)

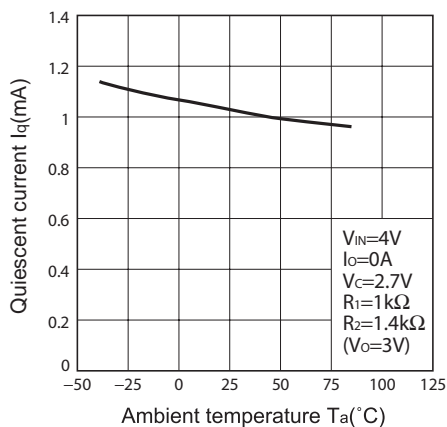

Fig.10 Ripple Rejection vs. Input Ripple Frequency (PQ070VK01FZH)

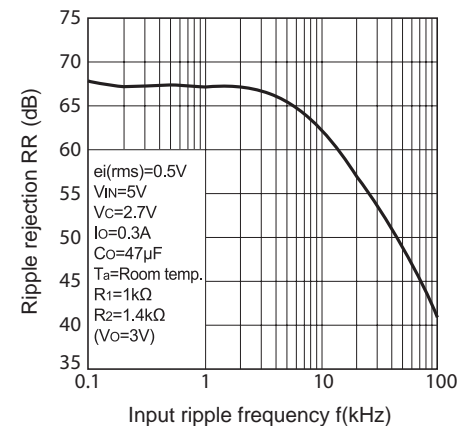

Fig.11 Ripple Rejection vs. Output Current (PQ070VK01FZH)

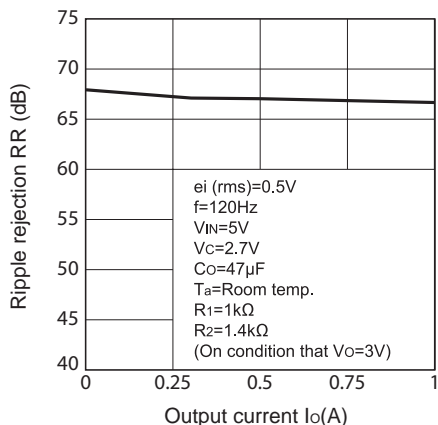

Fig.12 Overcurrent Protection Characteristics (Typical Value) (PQ070VK02FZH)

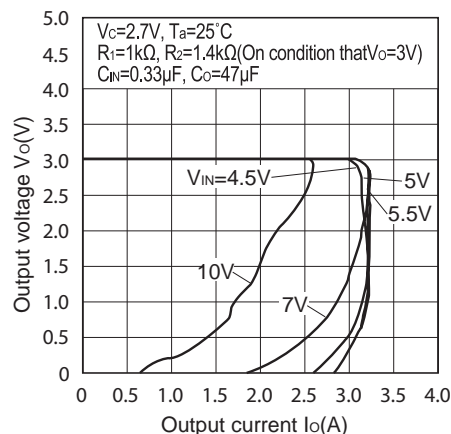

Fig.13 Reference Voltage Deviation vs. Junction Temperature (PQ070VK02FZH)

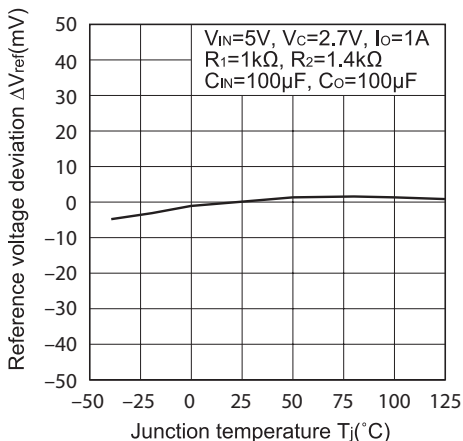

Fig.14 Output Voltage vs. Input Voltage (PQ070VK02FZH)

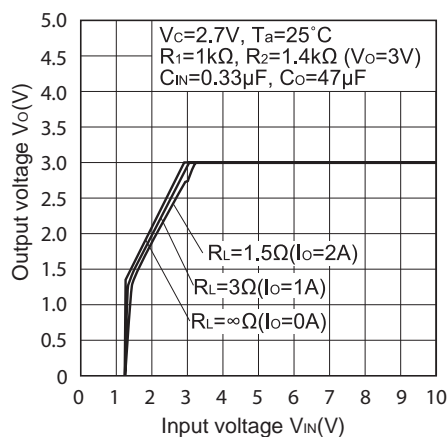

Fig.15 Circuit Operating Current vs. Input Voltage (PQ070VK02FZH)

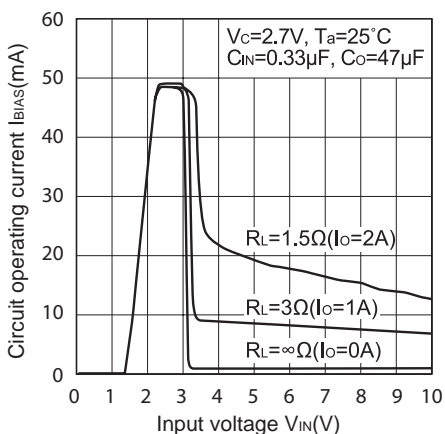

Fig.16 Dropout Voltage vs. Junction Temperature (PQ070VK02FZH)

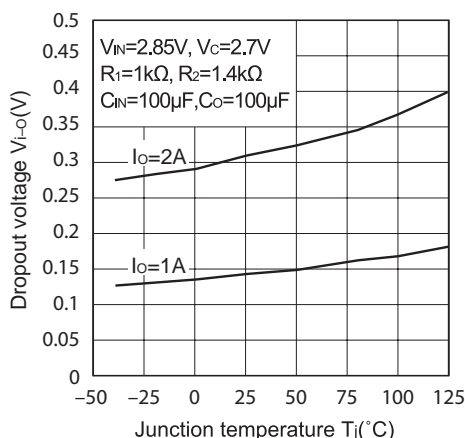

Fig.17 Quiescent Current vs. Junction Temperature (PQ070VK02FZH)

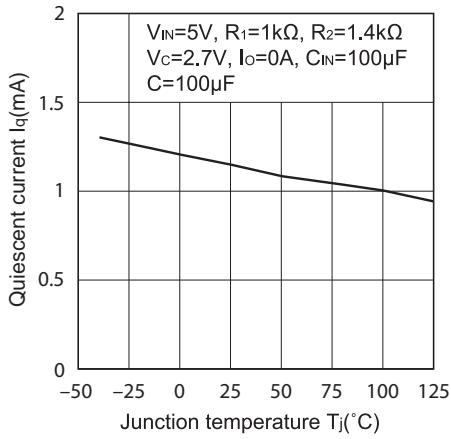

Fig.18 Ripple Rejection vs. Input Ripple Frequency (PQ070VK02FZH)

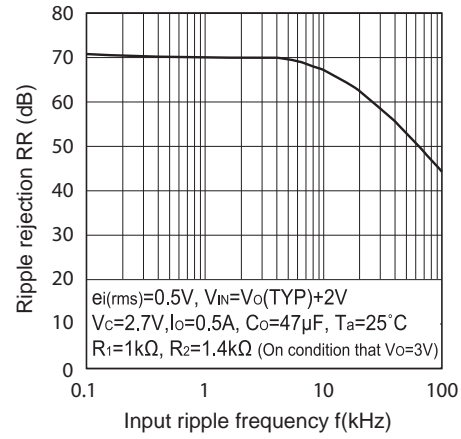

Fig.19 Ripple Rejection vs. Output Current (PQ070VK02FZH)

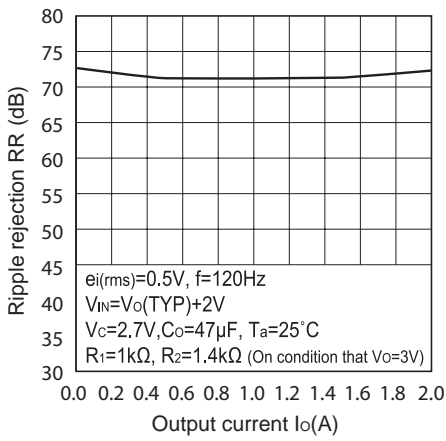

Fig.20 Output Voltage Adjustment Characteristics (Typical Value)

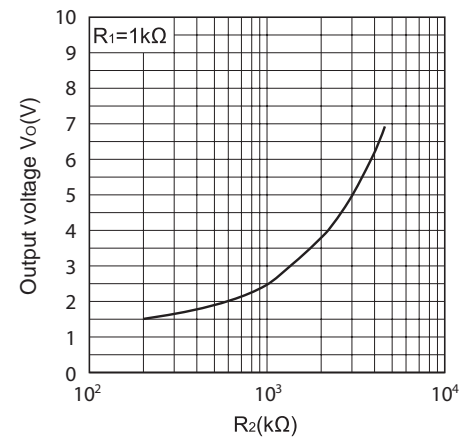
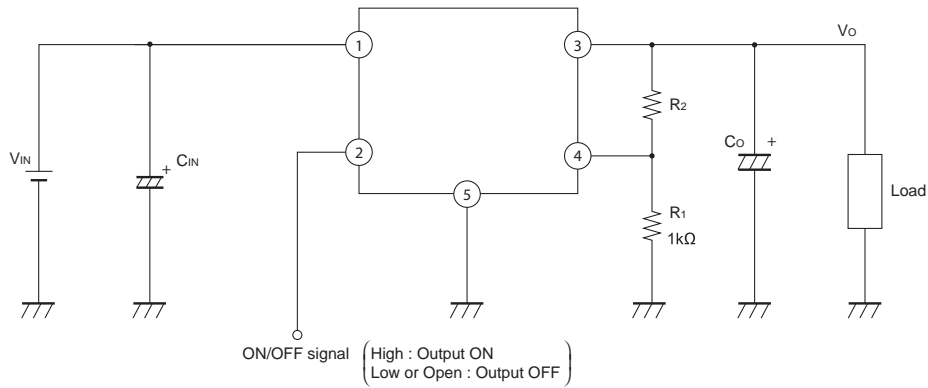

Fig.21 Typical Application



■ Setting of Output Voltage

Output voltage is able to set (1.5V to 7V) when resistors R<sub>1</sub>, R<sub>2</sub> are attached to ③,④,⑤ terminals. As for the external resistors to set output voltage, refer to the following figure and Fig.20.

