

ccRF click™

1. Introduction

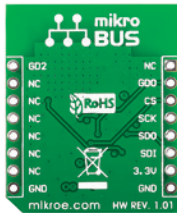
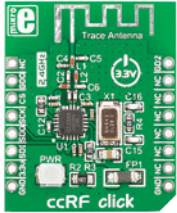

ccRF click™ is an accessory board in **mikroBUS™** form factor. It's a compact and easy solution for adding RF transceiver to your design. It features **CC2500** Low-Power 2.4 GHz RF transceiver as well as PCB trace antenna. ccRF click™ communicates with the target board microcontroller via **mikroBUS™** SPI (MOSI, MISO, SCK, CS), RST and PWM lines. The board is designed to use 3.3V power supply only. LED diode (GREEN) indicates the presence of power supply.

2. Soldering the headers

Before using your click™ board, make sure to solder 1x8 male headers to both left and right side of the board. Two 1x8 male headers are included with the board in the package.



2

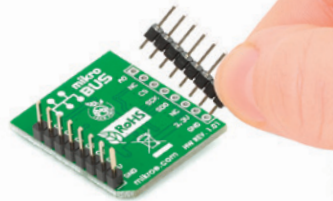

Turn the board upside down so that bottom side is facing you upwards. Place shorter pins of the header into the appropriate soldering pads.

3

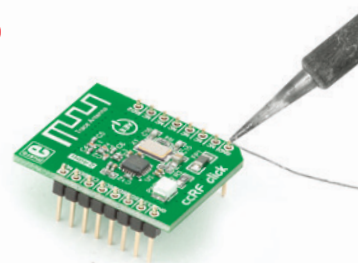

Turn the board upward again. Make sure to align the headers so that they are perpendicular to the board, then solder the pins carefully.

3. Plugging the board in

Once you have soldered the headers your board is ready to be placed into desired mikroBUS™ socket. Make sure to align the cut in the lower-right part of the board with the markings on the silkscreen at the mikroBUS™ socket. If all of the pins are aligned correctly, push the board all the way into the socket.

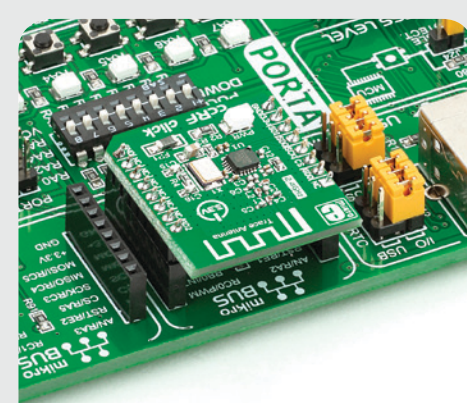
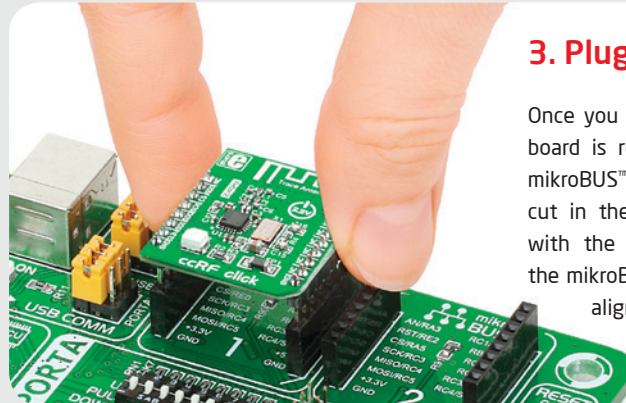

4. Essential features

ccRF click™ with its **CC2500** IC is a low-power 2.4 GHz transceiver designed for the 2400-2483.5 MHz ISM and SRD frequency band. The **CC2500** is integrated with a highly configurable baseband modem that supports various modulation formats and has data rate up to 500 kBaud. All these features make this board ideal for consumer electronics, wireless audio, wireless keyboard and mouse RF remote controls and many more.

click™
BOARD
www.mikroe.com



ccRF click Manual
ver. 1.01



5. ccRF click™ Board Schematic

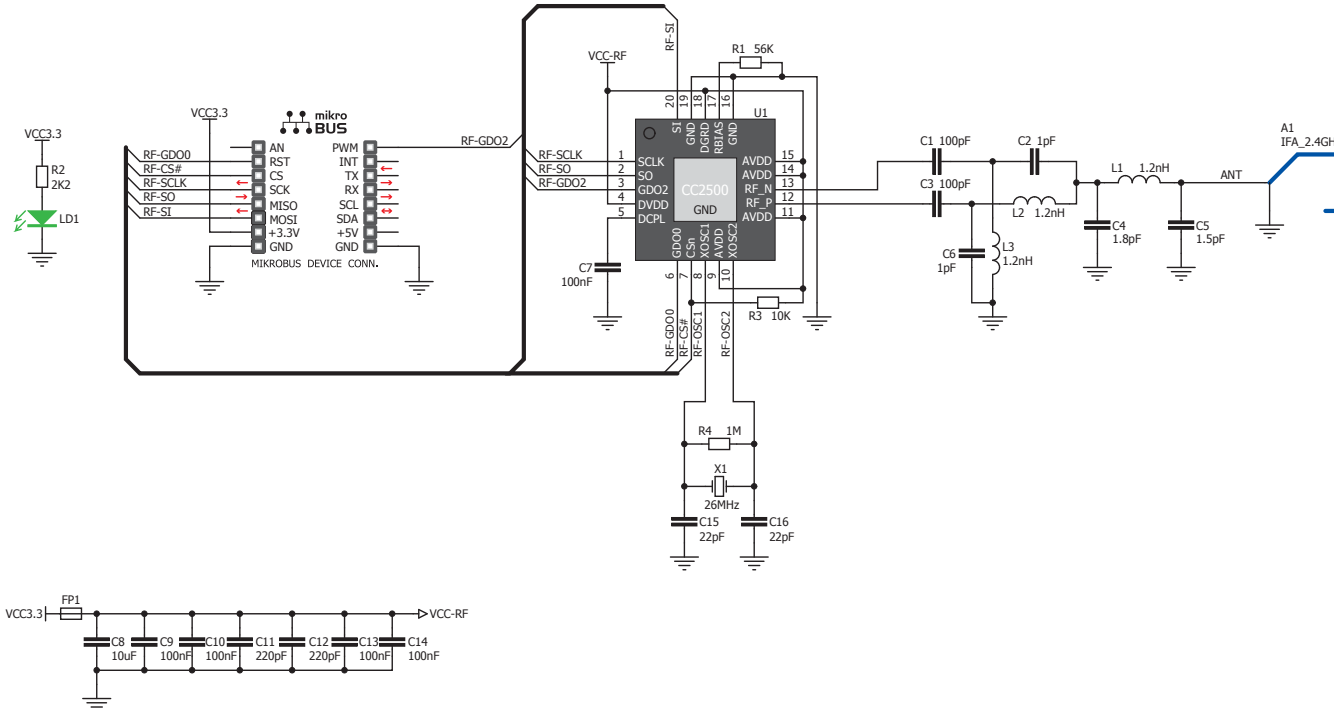

6. PCB Trace Antenna



Board features PCB trace antenna, designed for the 2400-2483.5 MHz frequency band. Maximum device range is up to 20 meters in open space.

7. Code Examples

Once you have done all the necessary preparations, it's time to get your click™ board up and running. We have provided the examples for mikroC™, mikroBasic™ and mikroPascal™ compilers on our **Libstock** website. Just download them and you are ready to start.



8. Support

MikroElektronika offers **Free Tech Support** (www.mikroe.com/esupport) until the end of product lifetime, so if something goes wrong, we are ready and willing to help!

