



SPECIFICATION FOR APPROVAL

Customer.	STD		
Description.	DC FAN		
Part No.		REV.	
Delta Model No.	GFC0812DW-DV55	REV.	00
Sample Issue No.			
Sample Issue Date.	AUG-20-2013		

**PLEASE SEND ONE COPY OF THIS SPECIFICATION
BACK AFTER YOU SIGNED APPROVAL FOR PRODUCTION
PRE-ARRANGEMENT.**

APPROVED BY : _____

DATE: _____

**Delta Electronics, Inc.
HeTianXia High-Tech Industrial Park.
Shi Jie Town, Dong Guan City.
Guangdong Province, China. P. R. C.
TEL : 86-769-86329008
FAX : 86-769-86631589**

Delta Electronics, Inc.
HeTianXia High-Tech Industrial Park.
Shi Jie Town, Dong Guan City.
Guangdong Province, China. P. R. C.

TEL : 86-769-86329008
FAX : 86-769-86631589

STATEMENT OF DEVIATION

NONE

DESCRIPTION :

Delta Electronics, Inc.
 HeTianXia High-Tech Industrial Park.
 Shi Jie Town, Dong Guan City.
 Guangdong Province, China. P. R. C.

TEL : 86-769-86329008
 FAX : 86-769-86631589

SPECIFICATION FOR APPROVAL

Customer: STD

 Description: DC FAN

 Customer P/N: REV:

 Delta Model NO.: GFC0812DW-DV55 Delta Safety Model NO.: GFC0812DW-SM00

 Sample Rev: 00 Issue NO:

 Sample Issue Date: AUG-19-2013 Quantity:

1. SCOPE:

THIS SPECIFICATION DEFINES THE ELECTRICAL AND MECHANICAL CHARACTERISTICS OF THE DC BRUSHLESS AXIAL FLOW FAN. THE FAN MOTOR IS WITH THREE PHASE AND FOUR POLES.

2. CHARACTERS:

ITEM	DESCRIPTION
RATED VOLTAGE	12 VDC
OPERATION VOLTAGE	10.8 - 12.6 VDC
INPUT CURRENT	5.80 (MAX. 6.96) A (SAFETY CURRENT: 7.20A)
INPUT POWER	69.6 (MAX. 83.52) W
SPEED	FRONT 12000 ± 10% R.P.M. REAR 10500 ± 10% R.P.M.
MAX. AIR FLOW (AT ZERO STATIC PRESSURE)	4.68 (MIN. 4.21) M ³ /MIN. 165.27 (MIN. 148.74) CFM
MAX. AIR PRESSURE (AT ZERO AIRFLOW)	101.39 (MIN. 82.13) mmH ₂ O 3.99 (MIN. 3.23) inchH ₂ O
ACOUSTICAL NOISE (AVG.)	76.7 (MAX. 80.7) dB-A
INSULATION TYPE	UL:CLASS A

(continued)

PART NO:

DELTA MODEL: GFC0812DW-DV55

INSULATION STRENGTH	10 MEG OHM MIN. AT 500 VDC (BETWEEN FRAME AND (+) TERMINAL)
DIELECTRIC STRENGTH	5 mA MAX. AT 500 VAC 50/60 Hz ONE MINUTE, (BETWEEN FRAME AND (+) TERMINAL)
EXTERNAL COVER	OPEN TYPE
LIFE EXPECTANCE (AT LABEL VOLTAGE)	70000 HOURS CONTINUOUS OPERATION AT 40 °C WITH 15 ~ 65 %RH.
ROTATION	TWO FANS ROTATE IN COUNTER DIRECTIONS SHOWED IN THE NAME PLATE SIDE
OVER CURRENT SHUT DOWN	THE CURRENT WILL SHUT DOWN WHEN LOCKING ROTOR.
LEAD WIRE	UL 1430 -F- AWG #22 UL 1430 -F- AWG #22 FRONT FAN(FIVE BLADES): REAR FAN(FOUR BLADES): RED WIRE POSITIVE(+) RED WIRE POSITIVE(+) BLACK WIRE NEGATIVE(-) BLACK WIRE NEGATIVE(-) UL 1430 -F- AWG #28 UL 1430 -F- AWG #28 FRONT FAN(FIVE BLADES): REAR FAN(FOUR BLADES): WHITE WIRE FREQUENCY(-FOO) ORANGE WIRE FREQUENCY(-FOO) YELLOW WIRE SPEED CONTROL(PWM) GREEN WIRE SPEED CONTROL(PWM)

- NOTES:
1. ALL READINGS ARE MEASURED AFTER STABLY WARMING UP THROUGH 10 MINUTES.
 2. STANDARD AIR PROPERTY IS AIR AT (Td) 25°C TEMPERATURE, (RH) 65% RELATIVE HUMIDITY, AND (Pb) 760 mmHg BAROMETRIC PRESSURE.
 3. THE VALUES WRITTEN IN PARENS , (), ARE LIMITED SPEC.
 4. THE CHARACTERS SHOWED IN PAGE 1 IS THE CONDITION OF BOTH FANS RUN.
 5. ACOUSTICAL NOISE MEASURING CONDITION:

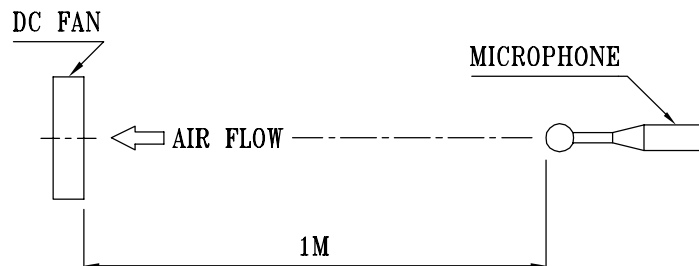

NOISE IS MEASURED AT RATED VOLTAGE IN FREE AIR IN ANECHOIC CHAMBER WITH B & K SOUND LEVEL METER WITH MICROPHONE AT A DISTANCE OF ONE METER FROM THE FAN INTAKE.

PART NO:

DELTA MODEL: GFC0812DW-DV55

3. MECHANICAL:

- 3-1. DIMENSIONS ----- SEE DIMENSIONS DRAWING
- 3-2. FRAME ----- PLASTIC UL: 94V-0
- 3-3. IMPELLER ----- PLASTIC UL: 94V-0
- 3-4. BEARING SYSTEM ----- BALL BEARINGS
- 3-5. WEIGHT ----- 402 GRAMS

4. ENVIRONMENTAL:

- 4-1. OPERATING TEMPERATURE ----- -10 TO +70 DEGREE C
- 4-2. STORAGE TEMPERATURE ----- -40 TO +75 DEGREE C
- 4-3. OPERATING HUMIDITY ----- 5 TO 90 % RH
- 4-4. STORAGE HUMIDITY ----- 5 TO 95 % RH

5. PROTECTION:

5-1. LOCKED ROTOR PROTECTION

IMPEDANCE OF MOTOR WINDING PROTECTS MOTOR FROM FIRE IN 96 HOURS OF LOCKED ROTOR CONDITION AT THE RATED VOLTAGE.

5-2. POLARITY PROTECTION

BE CAPABLE OF WITHSTANDING IF REVERSE CONNECTION FOR POSITIVE AND NEGATIVE LEADS.

5-3. BRAKE PROTECTION

WHEN FAN'S START-UP VOLTAGE>8V, OPERATE FAN NORMAL START OR LOCKED ROTOR TO RESTART. FAN WILL BRAKE THEN START.
THE BRAKE TIME: 1000 ms (+200ms /-0ms)

6. RE OZONE DEPLETING SUBSTANCES:

- 6-1. NO CONTAINING PBBs, PBBOs, CFCs, PBBEs, PBDPEs AND HCFCs.

7. PRODUCTION LOCATION

- 7-1. PRODUCTS WILL BE PRODUCED IN CHINA OR THAILAND .

PART NO:

DELTA MODEL: GFC0812DW-DV55

8. P & Q CURVE:

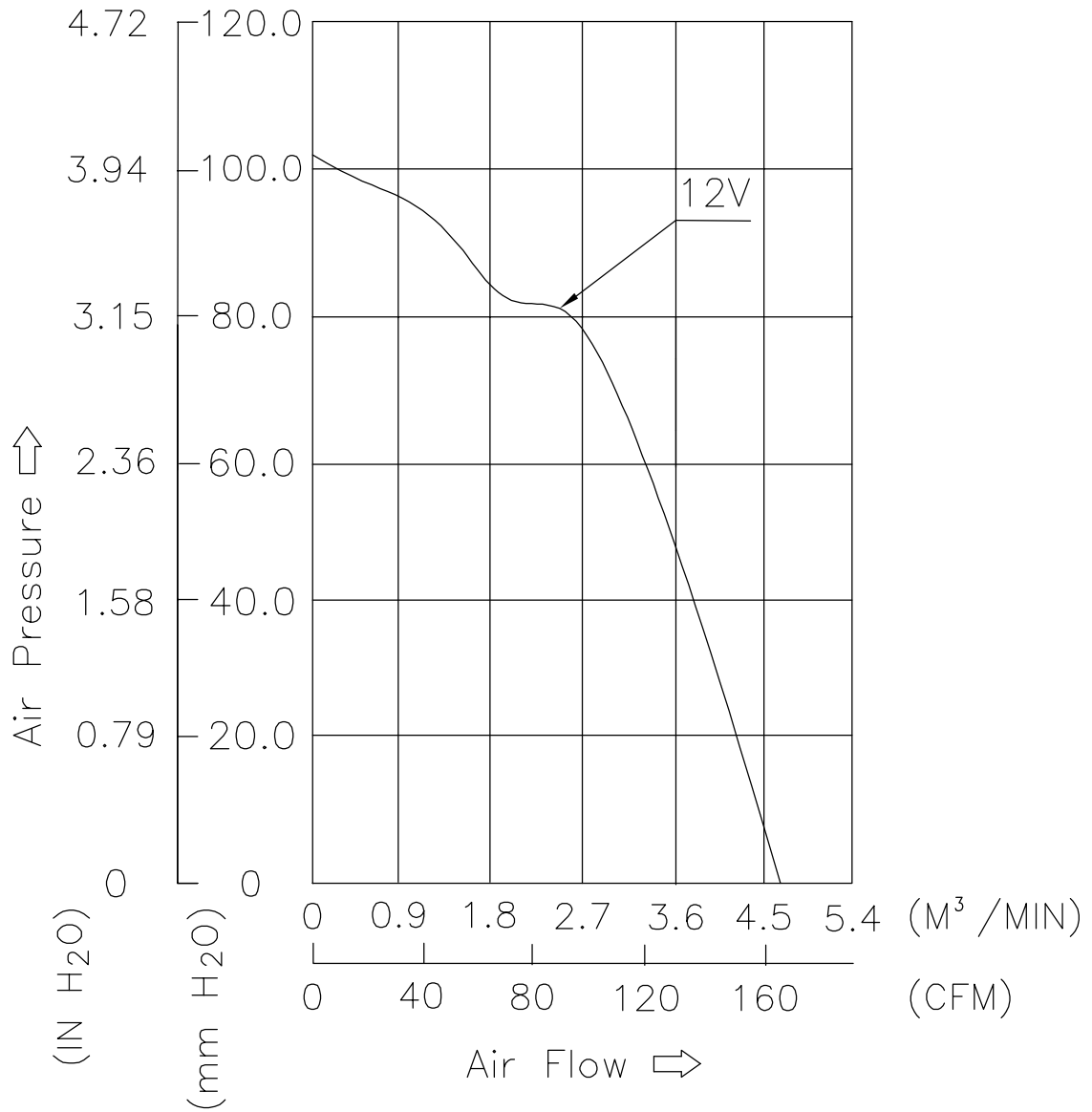

* TEST CONDITION: INPUT VOLTAGE ----- OPERATION VOLTAGE
TEMPERATURE ----- ROOM TEMPERATURE
HUMIDITY ----- 65%RH

PART NO:

DELTA MODEL: GFC0812DW-DV55

9. DIMENSION DRAWING:

LABEL:

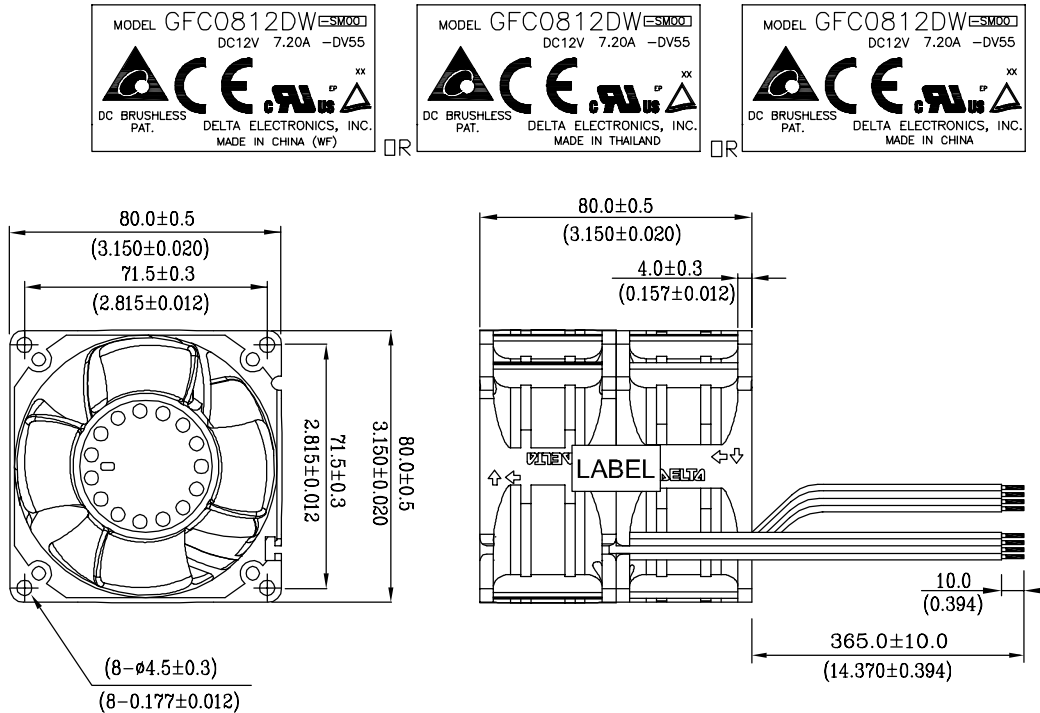

UNIT: MM(INCH)

NOTES :

1. LEAD WIRE: UL 1430

RED WIRE (+)(AWG22) --- INLET FAN

YELLOW WIRE (PWM)(AWG28) --- INLET FAN

WHITE WIRE (FG)(AWG28) --- INLET FAN

BLACK WIRE (-)(AWG22) --- INLET FAN

RED WIRE (+)(AWG22) --- OUTLET FAN

GREEN WIRE (PWM)(AWG28) --- OUTLET FAN

ORANGE WIRE (FG)(AWG28) --- OUTLET FAN

BLACK WIRE (-)(AWG22) --- OUTLET FAN

2. THIS PRODUCT IS RoHS COMPLIANT.

PART NO:

DELTA MODEL: GFC0812DW-DV55

10. FREQUENCY GENERATOR (FG) SIGNAL:

10-1. OUTPUT CIRCUIT - OPEN COLLECTOR MODE:

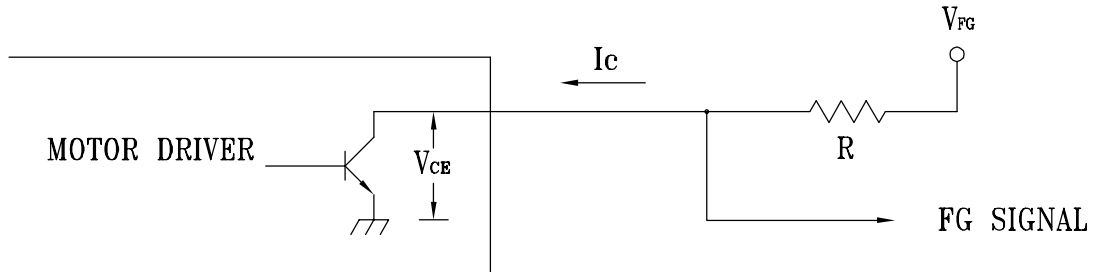

CAUTION:

THE LEAD WIRE OF FG SIGNAL CAN NOT TOUCH
THE LEAD WIRE OF POSITIVE OR NEGATIVE.

10-2. SPECIFICATION:

$V_{CE} (sat) = 0.5V \text{ MAX.}$

$V_{FG} = 13.5VDC \text{ MAX.}$

$I_c = 5mA \text{ MAX.}$

$R \geq V_{FG} / I_c$

10-3. FREQUENCY GENERATOR WAVEFORM:

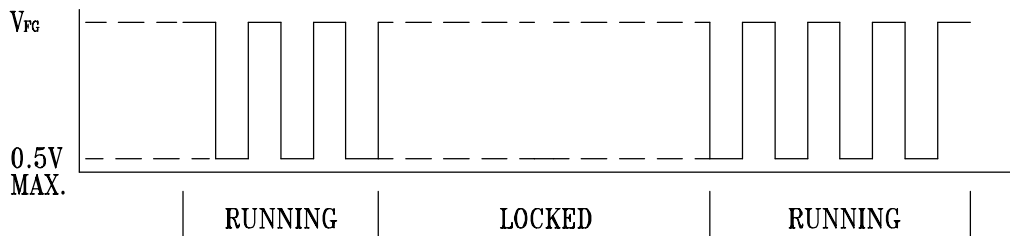

FAN RUNNING FOR 4 POLES

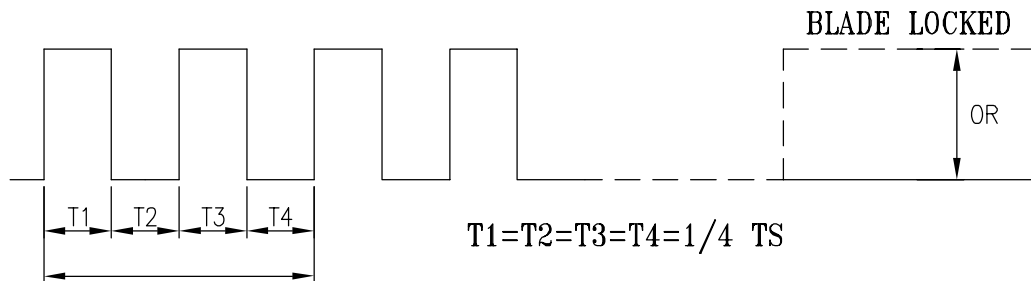

$N = \text{R.P.M}$

TS

$TS = 60/N(\text{SEC})$

*VOLTAGE LEVEL AFTER BLADE LOCKED

*4 POLES

PART NO:

DELTA MODEL: GFC0812DW-DV55

11. PWM CONTROL SIGNAL:

SIGNAL VOLTAGE RANGE: 0~15 VDC

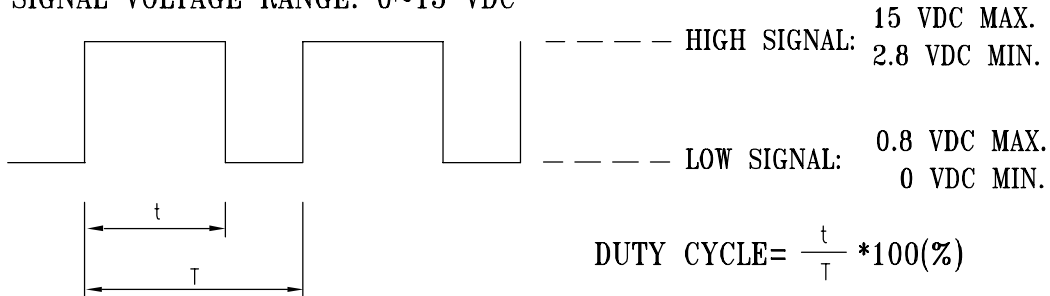

- THE PREFERRED OPERATING POINT FOR THE FAN IS 25K HZ.
- AT 100% DUTY CYCLE,THE ROTOR WILL SPIN AT MAXIMUM SPEED.
- AT 0% DUTY CYCLE,THE ROTOR WILL SPIN AT MAXIMUM SPEED.
- WITH CONTROL SIGNAL LEAD DISCONNECTED,THE FAN WILL SPIN AT MAXIMUM SPEED.

12. SPEED VS PWM CONTROL SIGNAL:

(AT RATED VOLTAGE & PWM FREQUENCY=25KHZ)

DUTY CYCLE (%)	SPEED R.P.M. (REF.)		CURRENT (A) TYP.
	FRONT	REAR	TOTAL
100	12000±10%	10500±10%	5.80 A
0	12000±10%	10500±10%	5.80 A

13. PWM CONTROL LEAD WIRE INPUT IMPEDANCE:

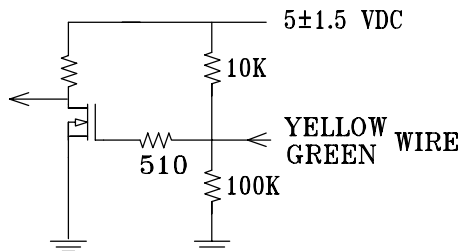

13-1. THE FAN SPEED WILL DEFAULT TO MAXIMUM WHEN THE SPEED CONTROL INPUT IS LEFT UNCONNECTED.

PART NO:

DELTA MODEL: GFC0812DW-DV55

13-2. PWM CURVE (FRONT & REAR)

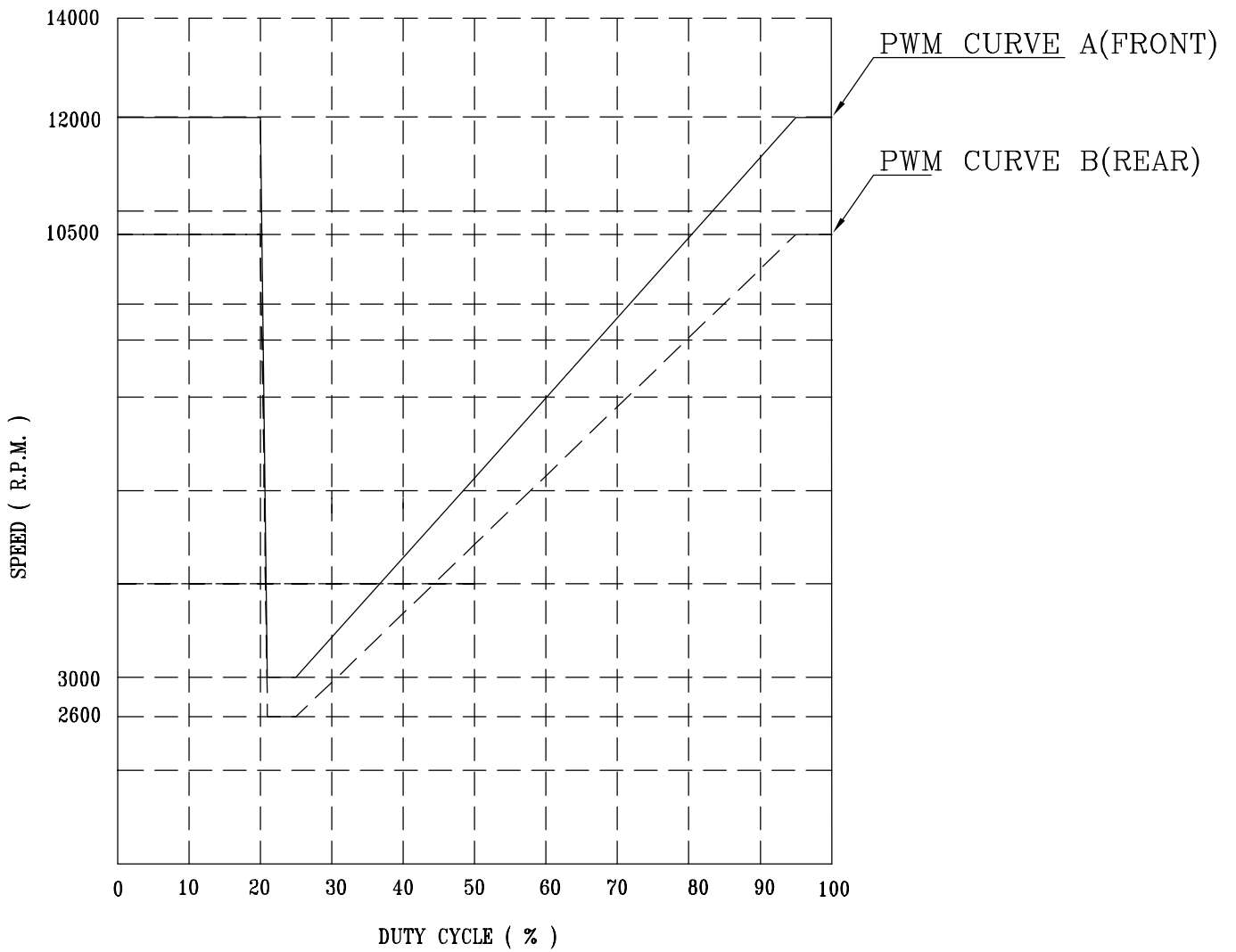



Application Notice

- 1. Delta will not guarantee the performance of the products if the application condition falls outside the parameters set forth in the specification.**
- 2. A written request should be submitted to Delta prior to approval if deviation from this specification is required.**
- 3. Please exercise caution when handling fans. Damage may be caused when pressure is applied to the impeller, if the fans are handled by the lead wires, or if the fan was hard-dropped to the production floor.**
- 4. Except as pertains to some special designs, there is no guarantee that the products will be free from any such safety problems or failures as caused by the introduction of powder, droplets of water or encroachment of insect into the hub.**
- 5. The above-mentioned conditions are representative of some unique examples and viewed as the first point of reference prior to all other information.**
- 6. It is very important to establish the correct polarity before connecting the fan to the power source. Positive (+) and Negative (-). Damage may be caused to the fans if connection is with reverse polarity, if there is no foolproof method to protect against such error specifically mentioned in this spec.**
- 7. Delta fans without special protection are not suitable where any corrosive fluids are introduced to their environment.**
- 8. Please ensure all fans are stored according to the storage temperature limits specified. Do not store fans in a high humidity environment. We highly recommend performance testing is conducted before shipping, if the fans have been stored over 6 months.**
- 9. Not all fans are provided with the Lock Rotor Protection feature. If you impair the rotation of the impeller for the fans that do not have this function, the performance of those fans will lead to failure.**
- 10. Please be cautious when mounting the fan. Incorrect mounting of fans may cause excess resonance, vibration and subsequent noise.**
- 11. It is important to consider safety when testing the fans. A suitable fan guard should be fitted to the fan to guard against any potential for personal injury.**
- 12. Except where specifically stated, all tests are carried out at room (ambient) temperature and relative humidity conditions of 25°C, 65% RH. The test value is only for fan performance itself.**
- 13. Be certain to connect an “ 4.7μF or greater” capacitor to the fan externally when the application calls for using multiple fans in parallel, to avoid any unstable power.**