

SECTION A-A
(WITHOUT CAP)

SECTION A-A
(WITH CAP)

NOTES:

- MATERIAL:
HOUSING: NYLON, GLASS FILLED, UL94 V-0,
COLOR - SEE TABLE.
CAP: NYLON, GLASS FILLED, UL94V-0
COLOR: BEIGE.
PINS: BRASS ALLOY, C26000, P/N87437-8083.
- PLATING: 2.54µM. MIN. TIN OVER 1.27µM MIN. NICKEL.
- DRAWING SHOWS PLUG WITH 5 CIRCUITS.
- HEADER TO BE USED WITH CRIMP HOUSING, P/N 87439
AND CRIMP TERMINAL, P/N 87421.
- PARTS TO BE PACKED IN MOISTURE BAG.

ADD MOIST BAG NOTE EC NO: S2007-1049 DRWNS:KANG CHKD:ATSEE APPR:MLONG	2007/06/22	QUALITY SYMBOLS ▽=0 ▽C=0	GENERAL TOLERANCES (UNLESS SPECIFIED)		DIMENSION STYLE MM ONLY		SCALE NTS	DESIGN UNITS METRIC	THIRD ANGLE PROJECTION	
	2007/06/22		DESCRIPTION	mm	INCH	DRAWN BY KCLING	DATE 1994/04/08	TITLE 1.50MM PITCH, W-T-B HEADER, VERTICAL, SMT	MOLEX INCORPORATED	
	2007/06/22		REV	4 PLACES ± --- ± ---	3 PLACES ± --- ± ---	CHECKED BY SKTOH	DATE 1994/04/21			
	D7			2 PLACES ± 0.20 ± ---	1 PLACE ± --- ± ---	APPROVED BY RWONG	DATE 1994/04/21			

DRAFT WHERE APPLICABLE MUST REMAIN WITHIN DIMENSIONS	ANGULAR ± 3°	SEE TABLE
--	--------------	-----------

MATERIAL NO.	DOCUMENT NO.	SHEET NO.
	SD-87437-***31	1 OF 4
THIS DRAWING CONTAINS INFORMATION THAT IS PROPRIETARY TO MOLEX INCORPORATED AND SHOULD NOT BE USED WITHOUT WRITTEN PERMISSION		

10 9 8 7 6 5 4 3 2 1



CIRCUIT SIZE	A	B	C	D	E
02	1.50	3.30	3.70	4.30	1.70
03	3.00	4.80	5.20	5.80	3.20
04	4.50	6.30	6.70	7.30	4.70
05	6.00	7.80	8.20	8.80	6.20
06	7.50	9.30	9.70	10.30	7.70
07	9.00	10.80	11.20	11.80	9.20
08	10.50	12.30	12.70	13.30	10.70
09	12.00	13.80	14.20	14.80	12.20
10	13.50	15.30	15.70	16.30	13.70
11	15.00	16.80	17.20	17.80	15.20
12	16.50	18.30	18.70	19.30	16.70
13	18.00	19.80	20.20	20.80	18.20
14	19.50	21.30	21.70	22.30	19.70
15	21.00	22.80	23.20	23.80	21.20

PART NUMBER ASSIGNMENT

87437-XXXX

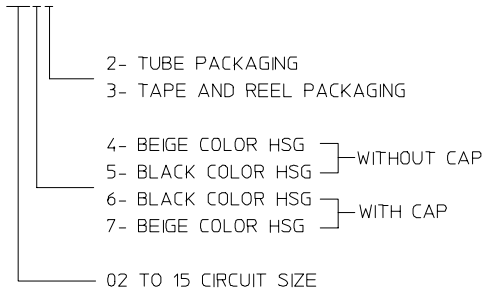

ADD MOIST BAG NOTE EC NO: S2007-1049 DRWN:SKANG CHKD:ATSEE APPR:MLONG	2007/06/22	DESCRIPTION REV
	2007/06/22	
	2007/06/22	
	2007/06/22	
D7		

QUALITY SYMBOLS	$\blacktriangledown = 0$ $\triangleleft = 0$
-----------------	---

GENERAL TOLERANCES (UNLESS SPECIFIED)		
	mm	INCH
4 PLACES	\pm ---	\pm ---
3 PLACES	\pm ---	\pm ---
2 PLACES	\pm 0.20	\pm ---
1 PLACE	\pm ---	\pm ---
ANGULAR \pm 3°		
DRAFT WHERE APPLICABLE MUST REMAIN WITHIN DIMENSIONS		

DIMENSION STYLE MM ONLY	
DRAWN BY KCLING	DATE 1994/04/08
CHECKED BY SKTOH	DATE 1994/04/21
APPROVED BY RWONG	DATE 1994/04/21
MATERIAL NO.	
SIZE A3	

SCALE NTS	DESIGN UNITS METRIC	THIRD ANGLE PROJECTION
TITLE 1.50MM PITCH, W-T-B HEADER, VERTICAL, SMT		
MOLEX INCORPORATED		
DOCUMENT NO. SD-87437-**31	SHEET NO. 2 OF 4	
THIS DRAWING CONTAINS INFORMATION THAT IS PROPRIETARY TO MOLEX INCORPORATED AND SHOULD NOT BE USED WITHOUT WRITTEN PERMISSION		

9 8 7 6 5 4 3 2 1

10 9 8 7 6 5 4 3 2 1

EMBOSSED CARRIER TAPE PACKING DETAILS FOR PARTS WITHOUT CAP



DETAIL A (ELONGATED HOLE)

CUSTOMER PULL OUT DIRECTION

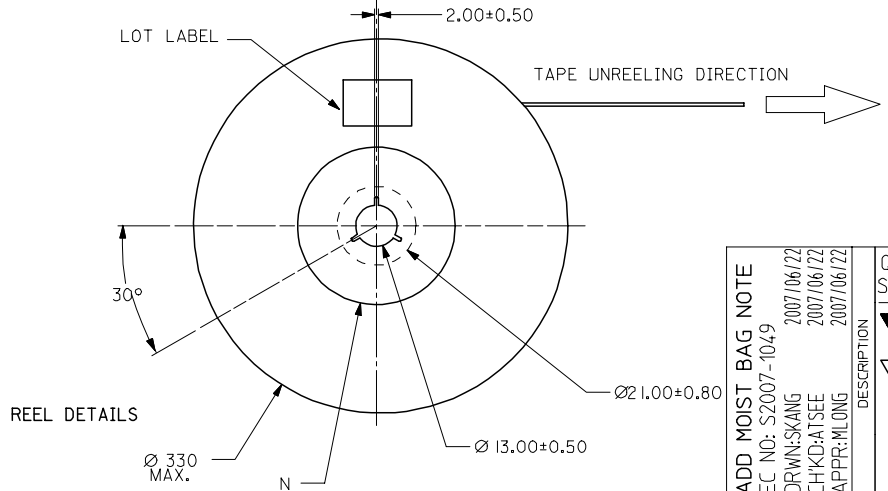
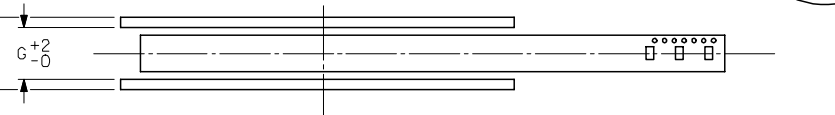
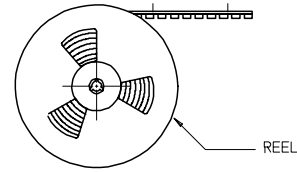

ADD MOIST BAG NOTE	DESCRIPTION
EC NO: S2007-1049	DRWNS:SKANG
2007/06/22	CHKD:ATSEE
2007/06/22	APPR:MLONG
2007/06/22	
D7	REV

QUALITY SYMBOLS	$\nabla=0$
	$\sphericalangle=0$

GENERAL TOLERANCES (UNLESS SPECIFIED)	DIMENSION STYLE	
	MM ONLY	
	mm	INCH
4 PLACES	\pm ---	\pm ---
3 PLACES	\pm ---	\pm ---
2 PLACES	± 0.20	\pm ---
1 PLACE	\pm ---	\pm ---
	ANGULAR $\pm 3^\circ$	
DRAFT WHERE APPLICABLE MUST REMAIN WITHIN DIMENSIONS		

DRAWN BY		DATE	
KCL ING		1994/04/08	
CHECKED BY		DATE	
SKTOH		1994/04/21	
APPROVED BY		DATE	
RWONG		1994/04/21	
MATERIAL NO.			
SEE TABLE			
SIZE A3			

SCALE	DESIGN UNITS	THIRD ANGLE PROJECTION	
NTS	METRIC		
TITLE		1.50MM PITCH, W-T-B HEADER, VERTICAL, SMT	
MOLEX INCORPORATED		MOLEX INCORPORATED	
DOCUMENT NO.		SHEET NO.	
SD-87437-**31		3 OF 4	
THIS DRAWING CONTAINS INFORMATION THAT IS PROPRIETARY TO MOLEX INCORPORATED AND SHOULD NOT BE USED WITHOUT WRITTEN PERMISSION			

9 8 7 6 5 4 3 2 1

EMBOSSED CARRIER TAPE PACKING DETAILS FOR PARTS WITH CAP

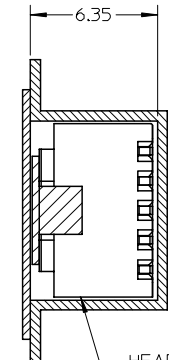
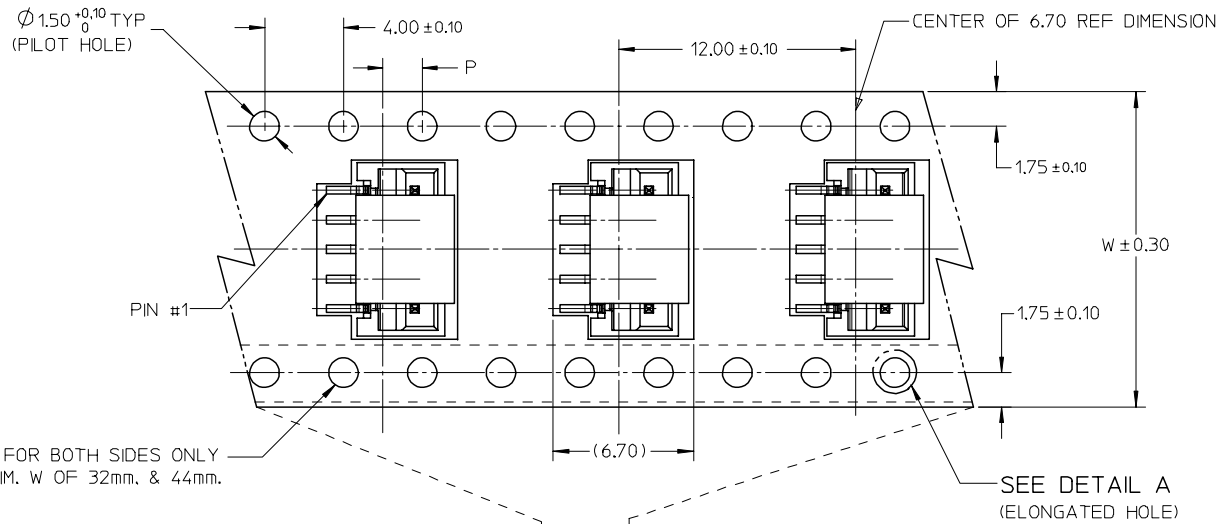

HEADER P/N:
87437-**-61 (BLACK)
87437-**-71 (BEIGE)

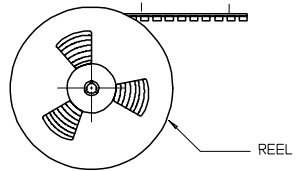

NOTES:

1. LEADER AND TRAILER TAPE

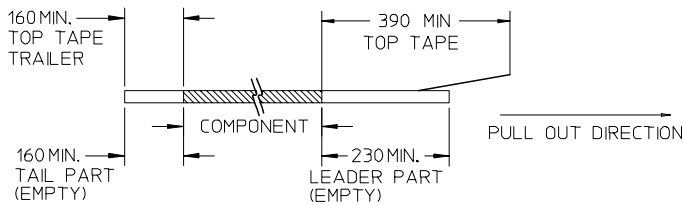

2. PEELING OFF FORCE OF THE TOP TAPE: 20-80gf.
(PEELING DIRECTION AS SHOWN IN FOLLOWING FIGURE)

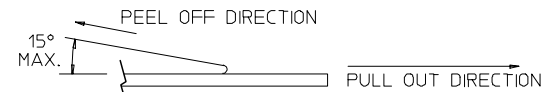

- 3. THE TAPE IS TREATED FOR ANTI-STATIC.
- 4. PACKAGING STANDARD IS AS PER EIA-481.
- 5. TAPE & REEL QUANTITY = 1000PCS/REEL (WITHOUT CAP)
TAPE & REEL QUANTITY = 900PCS/REEL (WITH CAP)

15	44	20.20±0.15	100	44.40	50.40	2.00±0.15
11, 12, 13, 14	32	14.20±0.10	100	32.40	38.40	2.00±0.10
7, 8, 9, 10	24	11.50±0.10	100	24.40	30.40	2.00±0.10
2, 3, 4, 5, 6	16	7.50±0.10	100	16.40	22.40	2.00±0.10
CIRCUIT SIZE	W	F	N	G	T MAX	P

ADD MOIST BAG NOTE EC NO: S2007-1049 DRWNS:KANG CHKD:ATSEE APPR:MLONG	2007/06/22	QUALITY SYMBOLS ▽=0 △=0
	2007/06/22	
	2007/06/22	
	2007/06/22	
D7	REV	DESCRIPTION

GENERAL TOLERANCES (UNLESS SPECIFIED)	
mm	INCH
4 PLACES	± --- ± ---
3 PLACES	± --- ± ---
2 PLACES	± 0.20 ± ---
1 PLACE	± --- ± ---
ANGULAR ± 3 °	
DRAFT WHERE APPLICABLE MUST REMAIN WITHIN DIMENSIONS	

DIMENSION STYLE MM ONLY	
DRAWN BY	DATE
DATE	TITLE
1994/04/08	1.50MM PITCH, W-T-B HEADER, VERTICAL, SMT
CHECKED BY	DATE
DATE	SKTOH
1994/04/21	APPROVED BY
DATE	RWONG
1994/04/21	MATERIAL NO.
DATE	DOCUMENT NO.
DATE	SD-87437-**-31
DATE	SHEET NO.
DATE	4 OF 4

SCALE NTS	DESIGN UNITS METRIC	THIRD ANGLE PROJECTION
MOLEX INCORPORATED		
THIS DRAWING CONTAINS INFORMATION THAT IS PROPRIETARY TO MOLEX INCORPORATED AND SHOULD NOT BE USED WITHOUT WRITTEN PERMISSION		