

Bare PCB evaluation board for the dual operational amplifier family in an MSO8 package

Data brief

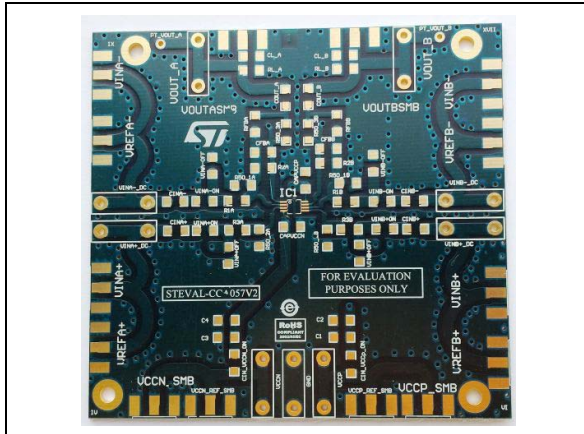

Description

The STEVAL-CCA057V2 evaluation board is designed to help customers quickly prototype new dual op amp circuits in an MSO8 package and reduce design time.

It can be used with almost any STMicroelectronics dual op amp in various configurations and applications.

The STEVAL-CCA057V2 is a bare board. There are no components or amplifiers soldered on the board. The components must be ordered separately.

Features

- The board with its components allow it to be configured as:
 - Sallen-key filter
 - Instrument amplifier
 - AC-coupled circuit
 - Out-of-loop compensation circuit
 - In loop compensation circuit
 - Transimpedance amplifier
 - Gain amplifier
 - Numerous other possible configurations
- RoHS compliant

1 Schematic diagram

Figure 1. STEVAL-CCA057V2 circuit schematic

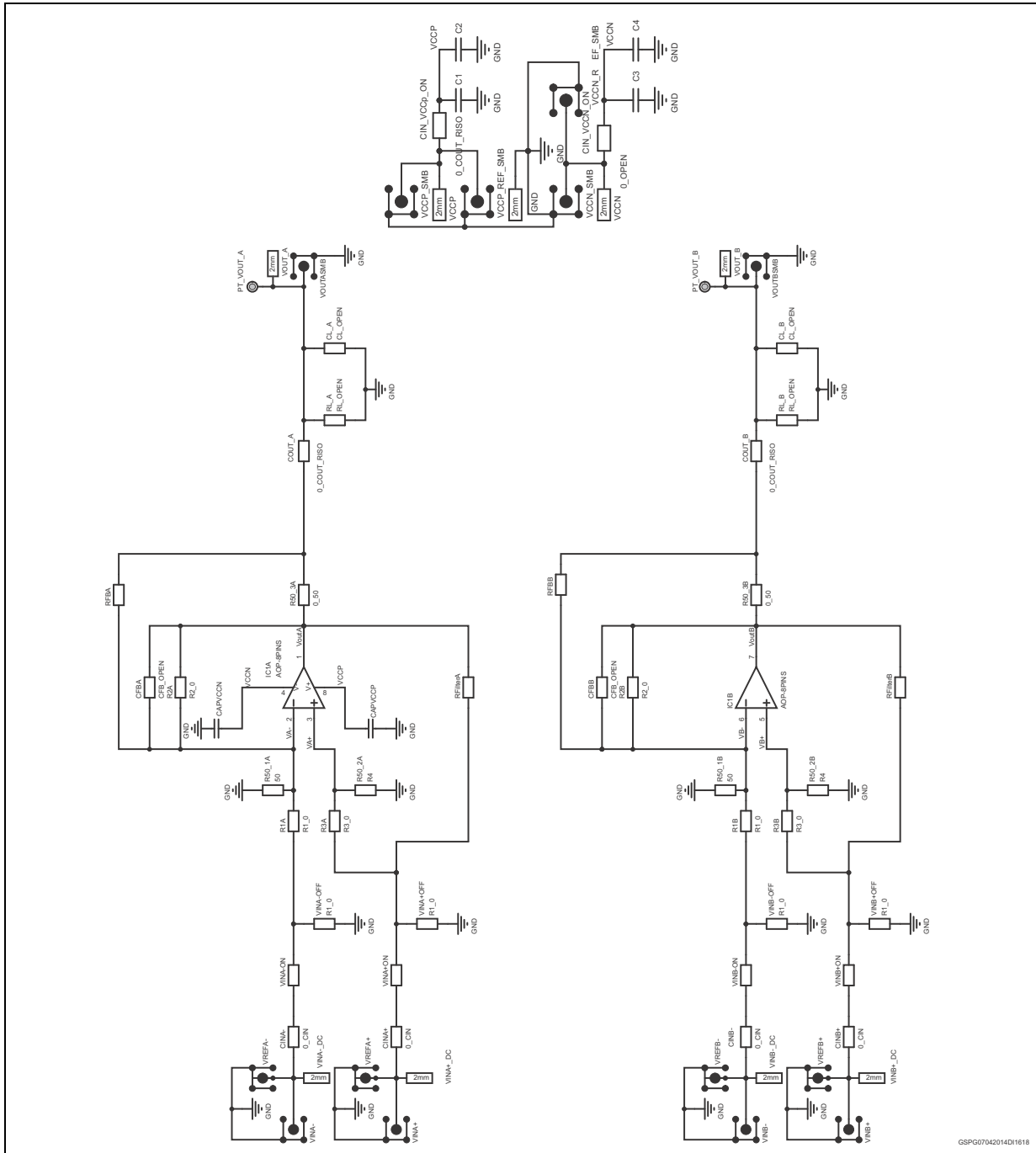

2 Revision history

Table 1. Document revision history

Date	Revision	Changes
07-Aug-2014	1	Initial release.

IMPORTANT NOTICE – PLEASE READ CAREFULLY

STMicroelectronics NV and its subsidiaries ("ST") reserve the right to make changes, corrections, enhancements, modifications, and improvements to ST products and/or to this document at any time without notice. Purchasers should obtain the latest relevant information on ST products before placing orders. ST products are sold pursuant to ST's terms and conditions of sale in place at the time of order acknowledgement.

Purchasers are solely responsible for the choice, selection, and use of ST products and ST assumes no liability for application assistance or the design of Purchasers' products.

No license, express or implied, to any intellectual property right is granted by ST herein.

Resale of ST products with provisions different from the information set forth herein shall void any warranty granted by ST for such product.

ST and the ST logo are trademarks of ST. All other product or service names are the property of their respective owners.

Information in this document supersedes and replaces information previously supplied in any prior versions of this document.

© 2014 STMicroelectronics – All rights reserved