

LOC	DIST	REVISIONS				
P	LTR	DESCRIPTION	DATE	DWN	APVD	
E	B	BA	NEW RELEASE	10JULY2010	PT	St.P

FOR FURTHER INFORMATION SEE DATA SHEET FOR
SERIES S - SMD PRECISION CURRENT SENSE RESISTOR

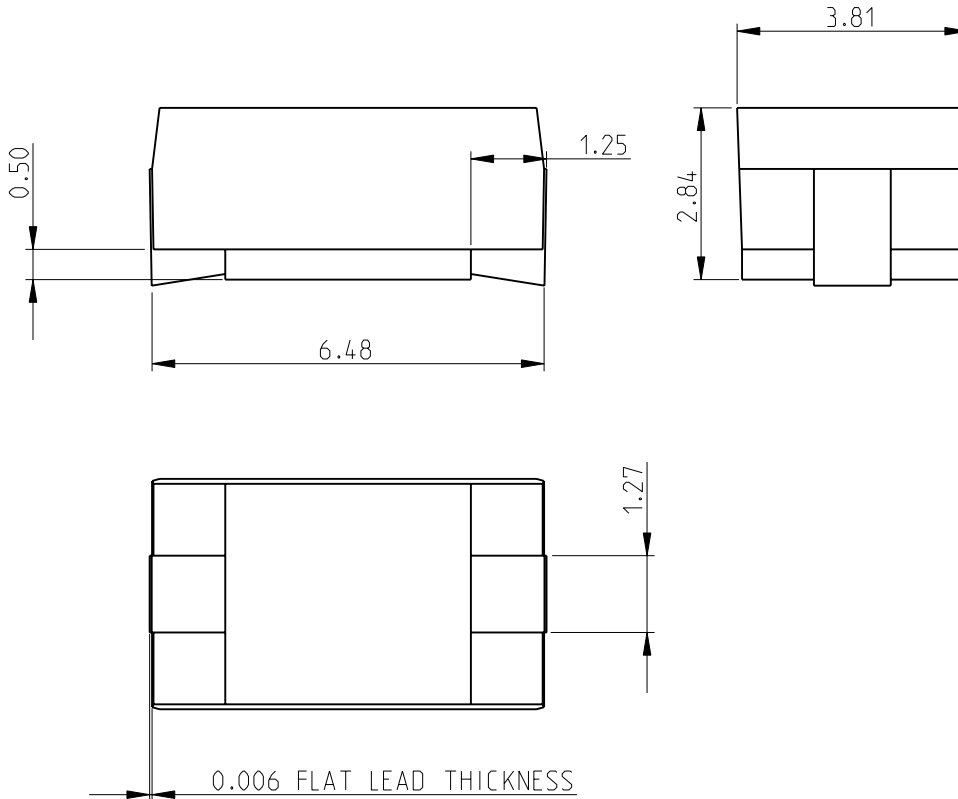

RECOMMENDED LAND PATTERN

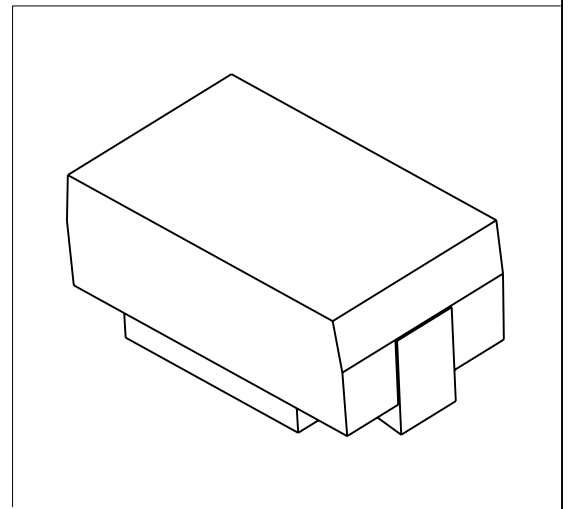
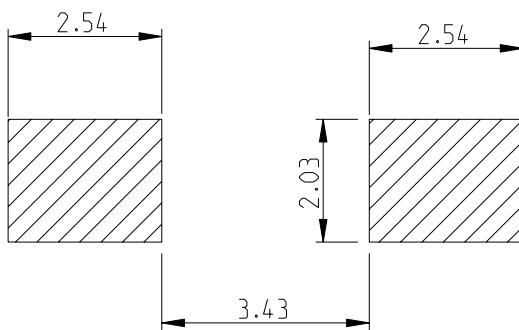

2008

RELEASED FOR PUBLICATION

THIS DRAWING IS UNPUBLISHED.

© COPYRIGHT 2008 BY TYCO ELECTRONICS CORPORATION. ALL RIGHTS RESERVED.

DIMENSIONS: mm	DWN PARUSURAM.T	10JULY2010	MATERIAL	-	FINISH	-
	CHK ALLAN.P	10JULY2010	Tyco Electronics Corporation Dorcan, Swindon, SN3 5HH			
TOLERANCES UNLESS OTHERWISE SPECIFIED:	APVD STEPHEN.P	10JULY2010				
	0 PLC ±0.2	PRODUCT SPEC	SIZE	CAGE CODE	DRAWING NO	RESTRICTED TO
1 PLC ±0.1	-	-	A 4	00779	©=1624261	-
2 PLC ±	APPLICATION SPEC	-	CUSTOMER DRAWING			
3 PLC ±	-	-	SCALE	8:1	SHEET	1 OF 1
4 PLC ±	WEIGHT	-	REV BA			
ANGLES ±5°						