



User Manual

AIMB-285

**Intel® Core™ i7/i5/i3/Pentium/
Celeron LGA 1151 Mini-ITX with
DP++/HDMI/VGA, 2 COM, Dual
LAN, PCIe x4, miniPCle, DDR4,
DC Input**

ADVANTECH

Enabling an Intelligent Planet

Copyright

The documentation and the software included with this product are copyrighted 2016 by Advantech Co., Ltd. All rights are reserved. Advantech Co., Ltd. reserves the right to make improvements in the products described in this manual at any time without notice. No part of this manual may be reproduced, copied, translated or transmitted in any form or by any means without the prior written permission of Advantech Co., Ltd. Information provided in this manual is intended to be accurate and reliable. However, Advantech Co., Ltd. assumes no responsibility for its use, nor for any infringements of the rights of third parties, which may result from its use.

Acknowledgements

AMI is a trademark of Phoenix Technologies Ltd.

IBM and PC are trademarks of International Business Machines Corporation.

Intel® Core™ i7/i5/i3, Pentium, Celeron® is trademark of Intel Corporation

WinBond is a trademark of Winbond Corporation.

All other product names or trademarks are properties of their respective owners.

A Message to the Customer

Advantech Customer Services

Each and every Advantech product is built to the most exacting specifications to ensure reliable performance in the harsh and demanding conditions typical of industrial environments. Whether your new Advantech equipment is destined for the laboratory or the factory floor, you can be assured that your product will provide the reliability and ease of operation for which the name Advantech has come to be known.

Your satisfaction is our primary concern. Here is a guide to Advantech's customer services. To ensure you get the full benefit of our services, please follow the instructions below carefully.

Technical Support

We want you to get the maximum performance from your products. So if you run into technical difficulties, we are here to help. For the most frequently asked questions, you can easily find answers in your product documentation. These answers are normally a lot more detailed than the ones we can give over the phone.

So please consult this manual first. If you still cannot find the answer, gather all the information or questions that apply to your problem, and with the product close at hand, call your dealer. Our dealers are well trained and ready to give you the support you need to get the most from your Advantech products. In fact, most problems reported are minor and are able to be easily solved over the phone.

In addition, free technical support is available from Advantech engineers every business day. We are always ready to give advice on application requirements or specific information on the installation and operation of any of our products.

Declaration of Conformity

FCC Class B

This device complies with the requirements in part 15 of the FCC rules:

Operation is subject to the following two conditions:

- This device may not cause harmful interference
- This device must accept any interference received, including interference that may cause undesired operation.

This equipment has been tested and found to comply with the limits for a Class B digital device, pursuant to Part 15 of the FCC Rules. These limits are designed to provide reasonable protection against harmful interference when the equipment is operated in a commercial environment. This equipment generates, uses, and can radiate radio frequency energy and, if not installed and used in accordance with the instruction manual, may cause harmful interference to radio communications. Operation of this device in a residential area is likely to cause harmful interference in which case the user will be required to correct the interference at his/her own expense. The user is advised that any equipment changes or modifications not expressly approved by the party responsible for compliance would void the compliance to FCC regulations and therefore, the user's authority to operate the equipment.

Caution! *There is a danger of a new battery exploding if it is incorrectly installed. Do not attempt to recharge, force open, or heat the battery. Replace the battery only with the same or equivalent type recommended by the manufacturer. Discard used batteries according to the manufacturer's instructions.*



CPU Compatibility

Processor_Number	Power(watt)	Cache	ES/QS/MP	Package type
i3-6100	51W	3MB	MP	LGA1151
i3-6100TE	35W	4MB	MP	LGA1151
i5-6400	65W	6MB	MP	LGA1151
i5-6500	65W	6MB	MP	LGA1151
i5-6500TE	35W	6MB	MP	LGA1151
i5-6600	65W	6MB	MP	LGA1151
i5-6600K	91W	6MB	MP	LGA1151
i7-6700	65W	8MB	MP	LGA1151
i7-6700TE	35W	8MB	MP	LGA1151
i7-6700K	91W	8MB	MP	LGA1151
Pentium G4400	54W	3M	MP	LGA1151

Memory Compatibility

Brand	Size	Speed	Type	ECC	Advantech PN
Transcend	16GB	DDR4 2133MHz	SODIMM	N	AQD-SD4U16N21-SE
Transcend	8GB	DDR4 2133MHz	SODIMM	N	AQD-SD4U8GN21-SG
Transcend	4GB	DDR4 2133MHz	SODIMM	N	AQD-SD4U4GN21-SG
ADATA	8G	DDR4 2133MHz	SODIMM	N	na
ADATA	4G	DDR4 2133MHz	SODIMM	N	na
ATP	8G	DDR4 2133MHz	SODIMM	N	na
ATP	4G	DDR4 2133MHz	SODIMM	N	na

Ordering Information

P/N	Chipset	DP	HDMI	VGA	LVDS	GbE LAN	SATA/ mSATA	USB3.0 /2.0	MiniPCle	TPM	PCIEx4	AMP
AIMB-285G2-00A1E	H110	1	1	1	(1)	2	3/1	4/8	2(1 x F/S; 1 x H/S)	(1)	1	(1)
AIMB-285L-00A1E	H110	1	1	0	(1)	1	3/1	4/6	1 x F/S	(1)	1	0

()BOM options available on MP version

Product Warranty (2 years)

Advantech warrants to you, the original purchaser, that each of its products will be free from defects in materials and workmanship for two years from the date of purchase.

This warranty does not apply to any products which have been repaired or altered by persons other than repair personnel authorized by Advantech, or which have been subject to misuse, abuse, accident or improper installation. Advantech assumes no liability under the terms of this warranty as a consequence of such events.

Because of Advantech's high quality-control standards and rigorous testing, most of our customers never need to use our repair service. If an Advantech product is defective, it will be repaired or replaced at no charge during the warranty period. For out-of-warranty repairs, you will be billed according to the cost of replacement materials, service time and freight. Please consult your dealer for more details.

If you think you have a defective product, follow these steps:

1. Collect all the information about the problem encountered. (For example, CPU speed, Advantech products used, other hardware and software used, etc.) Note anything abnormal and list any onscreen messages you get when the problem occurs.
2. Call your dealer and describe the problem. Please have your manual, product, and any helpful information readily available.
3. If your product is diagnosed as defective, obtain an RMA (return merchandise authorization) number from your dealer. This allows us to process your return more quickly.
4. Carefully pack the defective product, a fully-completed Repair and Replacement Order Card and a photocopy proof of purchase date (such as your sales receipt) in a shippable container. A product returned without proof of the purchase date is not eligible for warranty service.

-
5. Write the RMA number visibly on the outside of the package and ship it prepaid to your dealer.

Initial Inspection

Before you begin installing your motherboard, please make sure that the following materials have been shipped:

- AIMB-285 Intel Core™ i7/i5/i3 LGA1151 Mini-ITX motherboard
- 1 x SATA HDD cable
- 1 x SATA Power cable
- 2 x Serial port cable
- 1 x I/O port bracket
- 1 x Startup manual
- 1 x Warranty card

If any of these items are missing or damaged, contact your distributor or sales representative immediately. We have carefully inspected the AIMB-285 mechanically and electrically before shipment. It should be free of marks and scratches and in perfect working order upon receipt. As you unpack the AIMB-285, check it for signs of shipping damage. (For example, damaged box, scratches, dents, etc.) If it is damaged or it fails to meet the specifications, notify our service department or your local sales representative immediately. Also notify the carrier. Retain the shipping carton and packing material for inspection by the carrier. After inspection, we will make arrangements to repair or replace the unit.

Contents

Chapter 1 General Information1

1.1	Introduction	2
1.2	Features	2
1.3	Specifications	2
1.3.1	System	2
1.3.2	Memory	2
1.3.3	Input/Output	2
1.3.4	Graphics.....	3
1.3.5	Ethernet LAN	3
1.3.6	Industrial features	3
1.3.7	Mechanical and environmental specifications.....	3
1.4	Jumpers and Connectors	3
	Table 1.1: Connectors List.....	3
	Table 1.2: Jumper List.....	4
1.5	Board Layout: Jumper and Connector Locations.....	5
	Figure 1.1 Jumper and Connector Location	5
1.6	AIMB-285 Board Diagram	6
	Figure 1.2 AIMB-285 Board Diagram	6
1.7	Safety Precautions	6
1.8	Jumper Settings	7
1.8.1	How to Set Jumpers.....	7
1.8.2	CMOS Clear (CMOS1)	7
	Table 1.3: CMOS1	7
1.8.3	Power Switch/HDD LED/SMBUS/Speaker Pin Header (JFP1)	7
	Table 1.4: Power Switch/HDD LED/SMBUS/Speaker Pin Header(JFP1).....	7
1.8.4	Power LED and Keyboard Lock Pin Header (JFP2)	8
	Table 1.5: Power LED and keyboard Lock Pin Header(JFP2)	8
1.8.5	Watchdog Timer Output and OBS Beep (JWDT1+JOBS1).....	8
	Table 1.6: Watchdog Timer Output and OBS Beep (JWDT1+JOBS1).....	8
1.8.6	ATX, AT Mode Selection (PSON2).....	8
	Table 1.7: PSON2: ATX, AT Mode Selector.....	8
1.8.7	LVDS Panel Voltage Selection (JLVDS1).....	9
	Table 1.8: LVDS Panel Voltage Selection (JLVDS1)	9
1.8.8	COM2 RI# pin RI#/5V/12V Select (JSETCOM2_V1).....	9
	Table 1.9: COM2 RI# pin RI#/5V/12V Select (JSETCOM2_V1) .	9
1.9	System Memory	9
1.10	Memory Installation Procedures.....	10
1.11	Cache Memory.....	10
1.12	Processor Installation	10

Chapter 2 Connecting Peripherals11

2.1	Introduction	12
2.2	LAN Ports & USB Ports (LAN1/ LAN12/USB312/ USB334/USB56/USB78) 12	
	Table 2.1: LAN LED Indicator.....	12
2.3	High Definition Multimedia Interface Connector(HDMI1)	13
2.4	Display Port (DP1)	13
2.5	PS/2 Keyboard and Mouse Connector (KBMS1)	14
2.6	CPU Fan Connector (CPU_FAN1).....	14
2.7	System FAN Connector (SYSFAN1).....	15
2.8	Power Switch/HDD LED/SMBUS/Speaker Pin Header (JFP1) & Power	

	LED and Keyboard Lock Pin Header (JFP2)	15
2.8.1	ATX soft power switch (JFP1/PWR_SW)	16
2.8.2	Reset (JFP1/RESET).....	16
2.8.3	HDD LED (JFP1/HDDLED)	16
2.8.4	External speaker (JFP1/SPEAKER).....	16
2.8.5	Power LED and keyboard lock connector (JFP2/PWR_LED & KEY LOCK).....	16
	Table 2.2: ATX power supply LED status (No support for AT power).....	16
2.9	SATA Signal Connector (SATA1 ~ SATA3).....	17
2.10	SATA_PWR1/2	17
2.11	HD Analog Audio Interface (AUDIO1,AUDIO2, FPAUD1).....	18
2.12	PCI-E x4 Slot (PCIEX4_1)	18
2.13	LVDS Panel Connector (LVDS1), BOM optional	19
2.14	LVDS Backlight Inverter Power Connector (INV1).....	19
2.15	MINIPCIE and mSATA Connector (MINIPCIE1).....	20
2.16	MINIPCIE Connector (MINIPCIE2) & SIM Card Socket (SIM1).....	20
2.17	HD Digital Audio Interface (SPDIF1).....	21
2.18	Audio Amplifier Output Connector (AMP1)	22
2.19	General purpose I/O Connector (GPIO1)	22
2.20	SPI BIOS Flash Socket (SPI1).....	23
2.21	SPI Programming Pin Header (SPI_CN1)	23
2.22	Low Pin Count Header (LPC1)	24
2.23	Case-Open Detect Connector (JCASE1).....	24
2.24	ATX 12V Power Supply Connector (ATX12V1) & ATX 5V Power Supply Connector (ATX5VSB1).....	25
2.25	Battery Header (BAT1)	25
2.26	CPU Socket (CPU1)	26
2.27	DDR4 SO-DIMM Socket (DIMMA1, DIMMB1).....	26

Chapter 3 BIOS Operation 27

3.1	Introduction	28
3.2	BIOS Setup	28
3.2.1	Main Menu	28
3.2.2	Advanced BIOS Features	29
3.2.3	Chipset Configuration Setting	50
3.2.4	Security Setting.....	67
3.2.5	Boot Setting	69
3.2.6	Save & Exit Configuration.....	70

Chapter 4 Software Introduction & Service 73

4.1	Introduction	74
4.2	Value-Added Software Services	74
4.2.1	Software API.....	74
4.2.2	Software Utility.....	76

Chapter 5 Chipset Software Installation Utility 77

5.1	Before You Begin.....	78
5.2	Introduction	78

Chapter 6 Graphic Setup 79

6.1	Introduction	80
6.2	Windows 7/8 driver installation	80

Chapter 7 LAN Configuration.....81

7.1	Introduction	82
7.2	Features	82
7.3	Installation	82
7.4	Windows® 7/8.1/10 Driver Setup (Realtek 8111G).....	82

Appendix A I/O Pin Assignments.....85

A.1	DC input Phoenix Connector.....	86
A.2	Display Port.....	86
A.3	High Definition Multimedia Interface	87
A.4	ATX Power supply (5VSB) connector	87
A.5	USB 3.0 Stack Connector	88
A.6	RJ45 2 Port	88
A.7	Battery Wafer Box	89
A.8	HD Analog Audio Interface.....	89
A.9	Front HD Analog Audio Interface	89
A.10	Audio Amplifier Output Connector.....	90
A.11	HD Digital Audio Interface.....	90
A.12	PCI-E x4 Slot.....	90
A.13	MINIPCIE and 3G Connector.....	91
A.14	USB 2.0 Connector	92
A.15	SATA Signal Connector	93
A.16	LVDS Backlight Inverter Power Connector	93
A.17	General Purpose I/O Pin Header	93
A.18	COM Port	94
A.19	PS/2 Keyboard and Mouse Connector.....	94
A.20	Low Pin Count Header	94
A.21	SYSTEM FAN Power Connector	95
A.22	SPI Programming Pin Header	95
A.23	SPI BIOS Flash Socket.....	95
A.24	CPU FAN Power Connector.....	96
A.25	SMBUS Programming INFINEON for +Vcore Controller	96
A.26	MINIPCIE and mSATA Connector	96
A.27	Video Graphics Array Connector	98
A.28	SATA Power Connector	98
A.29	LVDS Panel Connector	99
A.30	ATX 12V Power Supply Connector	100
A.31	SIM Card Connector	100

Chapter 1

General Information

1.1 Introduction

AIMB-285 is designed with the Intel® H110 for industrial applications that require both performance computing and enhanced power management capabilities. The motherboard supports Intel desktop Core i7/i5/i3/Pentium/Celeron processor up to 8 MB L3 cache and DDR4 SO-DIMM 2133 up to 32GB. A rich I/O connectivity of 2 serial ports, 10 x USB, dual GbE LAN, 3 x SATA ports.

1.2 Features

- **Rich I/O connectivity:** 2 x serial ports, 4 x USB 3.0, 10 x USB 2.0, 3 x SATA 3.0, Dual GbE LAN.
- **Standard Mini-ITX form factor with industrial feature:** The AIMB-285 is a full featured Mini-ITX motherboard with balanced expandability and performance.
- **Wide selection of storage devices:** SATA HDD, mSATA, customers benefit from the flexibility of using the most suitable storage device for larger capacity.
- **Optimized integrated graphic solution:** With Intel® Graphics Flexible, it supports versatile display options and 32/64 bit 3D graphics engine.

1.3 Specifications

1.3.1 System

- **CPU:** LGA1151 Intel desktop Core i7/i5/i3/Pentium/Celeron processors compliant.
- **BIOS:** AMI EFI 128 Mbit SPI.
- **System chipset:** Intel® H110.
- **SATA hard disk drive interface:**
 - Three on-board SATA connector with data transmission rates of up to 600 MB
 - One mSATA with Mini pcie interface with high speed data transmission.

1.3.2 Memory

- **RAM:** Up to 32 GB in 2 slots 260-pin SODIMM sockets. Supports dual channel DDR4 2133 MHz SDRAM.

1.3.3 Input/Output

- **PCI bus:** 1 PCIe x4 slot.
- **Serial ports:** Two serial ports, 1 x RS-232 & 1 x RS-232/422/485.
- **Keyboard and PS/2 mouse connector:** Supports one standard PS/2 keyboard, one standard PS/2 mouse.
- **USB port:** Supports up to ten USB ports with transmission rates up to 625 MB, 4 on board pin header with USB 2.0 and 4 external ports with USB 3.0.
- **GPIO connector:** 8-bit general purpose Input/Output.

Note! *Under Window 7 OS, all of USB 2.0/3.0 ports are not workable before XHCI driver is installed. Suggest to use PS/2 keyboard & mouse for XHCI driver install first*



1.3.4 Graphics

- **Controller:** Intel® HD Graphics 530.
- **Display memory:** 1 GB maximum shared memory with 2GB and above system memory installed.
- **VGA:** Supports VGA up to resolution 1920 x 1200 @ 60 Hz refresh rate.
- **LVDS:** Supports LVDS up to resolution 1920 x 1200.
- **HDMI:** Supports HDMI up to resolution 4096 x 2304 @ 24Hz.
- **Displayport1.2:** Supports Display port up to resolution 3840 x 2160 @ 60Hz.

1.3.5 Ethernet LAN

- Supports dual 10/100/1000 Mbps Ethernet port (s) via PCI Express x1 bus. which provides 500 MB/s data transmission rates.
- Controller: LAN1/2: Realtek 8111G x 2.

1.3.6 Industrial features

- Watchdog timer: Can generate a system reset. The watchdog timer is programmable, with each unit equal to one second or one minute (255 levels).

1.3.7 Mechanical and environmental specifications

- **Operating temperature:** 0 ~ 60° C (32 ~ 140° F, depending on CPU)
- **Storage temperature:** -40 ~ 85° C (-40 ~ 185° F)
- **Humidity:** 5 ~ 95% non-condensing
- **Power supply voltage:** +3.3 V, +5 V, +12 V, -12 V, 5 Vsb
- **Board size:** 170 mm x 170 mm (6.69" x 6.69")
- **Board weight:** 0.365 kg
- **Power supply voltage:** 12V_{DC} Input

1.4 Jumpers and Connectors

Connectors on the AIMB-285 motherboard link it to external devices such as hard disk drives and a keyboard. In addition, the board has a number of jumpers used to configure your system for your application.

The tables below list the function of each of the board jumpers and connectors. Later sections in this chapter give instructions on setting jumpers. Chapter 2 gives instructions for connecting external devices to your motherboard.

Table 1.1: Connectors List

Label	Function
DCIN1	DC input Phoenix Connector
DP1	DisplayPort
HDMI1	High Definition Multimedia Interface
ATX_5VSB1	ATX Power supply (5VSB) connector
USB312, USB334	USB 3.0 Stack Connector
PCH1	Platform Controller Hub
LAN1, LAN12	RJ45 port
BAT1	Battery Wafer Box
AUDIO1	HD Analog Audio Interface: Line-Out
AUDIO2	HD Analog Audio Interface: MIC

Table 1.1: Connectors List

FPAUD1	Front HD Analog Audio Interface
AMP1	Audio Amplifier Output Connector
SPDIF1	HD Digital Audio Interface
PCIEX4_1	PCI-E x 4 Slot
MINI-PCIE2	MINIPCIIE and 3G Connector
USB56, USB78	USB 2.0 Connector
SATA1, SATA2, SATA3	SATA Signal Connector
INV1	LVDS Backlight Inverter Power Connector
DIMMA1, DIMMB1	DDR4 SO-DIMM Socket
GPIO1	General Purpose I/O Pin Header
COM1, COM2	COM Port
KBMS1	PS/2 Keyboard and Mouse Connector
LPC1	Low Pin Count Header
SYSFAN1, SYSFAN2	SYSTEM FAN Power Connector
SPI_CN1	SPI Programming Pin Header
SPI1	SPI BIOS Flash Socket
CPUFAN1	CPU FAN Power Connector
JSMB1	SMBUS Programming INFINEON for +Vcore Controller
CPU1	LGA1151 CPU Socket
MINI-PCIE1	MINIPCIIE and mSATA Connector
VGA1	Video Graphics Array Connector
SATA_PWR1, SATA_PWR2	SATA Power Connector
LVDS1	LVDS Panel Connector
ATX12V1	ATX 12V Power Supply Connector
SIM1	SIM Card Connector
Buzzer	Buzzer
CPU0_BACKPLATE1	CPU Back Plate

Table 1.2: Jumper List

Label	Function
JLVDS_VCON1	LVDS VESA, JEIDA format selection pin header
JCMOS1	CMOS Clear Jumper
JWDT1+JOBS1	Watchdog Timer Output and OBS Beep
JSETCOM2_V1	COM2 RI# pin RI#/5V/12V Select
JCASEOP_SW1	Case open selection pin header
JFP2	Power LED and Keyboard Lock Pin Header
PSON2	ATX/AT Mode Selection
JFP1	Power Switch/HDD LED/SMBUS/Speaker Pin Header
JCASE1	Case-Open Detect Connector
JLVDS1	LVDS Panel Voltage Selection

1.5 Board Layout: Jumper and Connector Locations

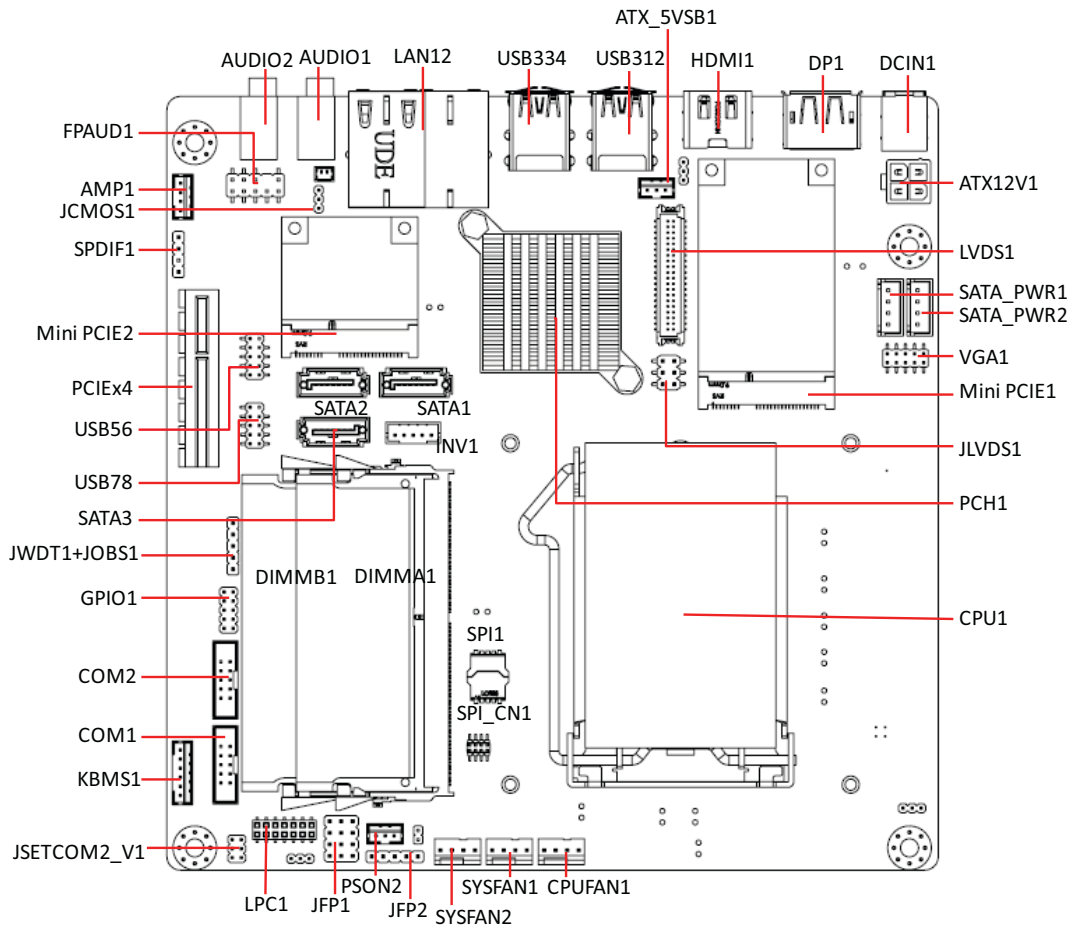

Figure 1.1 Jumper and Connector Location

1.6 AIMB-285 Board Diagram

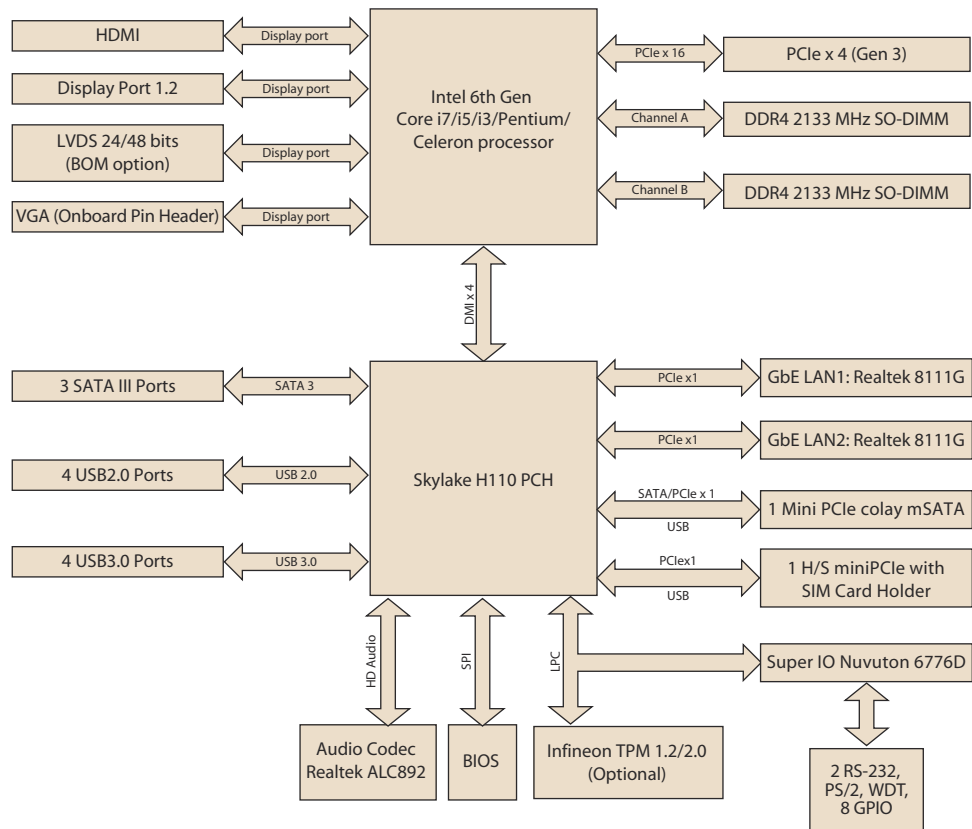

Figure 1.2 AIMB-285 Board Diagram

1.7 Safety Precautions

Warning! Always completely disconnect the power cord from chassis whenever you work with the hardware. Do not make connections while the power is on. Sensitive electronic components can be damaged by sudden power surges. Only experienced electronics personnel should open the PC chassis.



Caution! Always ground yourself to remove any static charge before touching the motherboard. Modern electronic devices are very sensitive to electrostatic discharges. As a safety precaution, use a grounding wrist strap at all times. Place all electronic components on a static-dissipative surface or in a static-shielded bag when they are not in the chassis.



Caution! The computer is provided with a battery-powered real-time clock circuit. There is a danger of explosion if battery is incorrectly replaced. Replace only with same or equivalent type recommended by the manufacturer. Discard used batteries according to manufacturer's instructions.



Caution! There is a danger of a new battery exploding if it is incorrectly installed. Do not attempt to recharge, force open, or heat the battery. Replace the battery only with the same or equivalent type recommended by the manufacturer. Discard used batteries according to the manufacturer's instructions.



1.8 Jumper Settings

This section provides instructions on how to configure your motherboard by setting the jumpers. It also includes the motherboards's default settings and your options for each jumper.



1.8.1 How to Set Jumpers

You can configure your motherboard to match the needs of your application by setting the jumpers. A jumper is a metal bridge that closes an electrical circuit. It consists of two metal pins and a small metal clip (often protected by a plastic cover) that slides over the pins to connect them. To “close” (or turn ON) a jumper, you connect the pins with the clip. To “open” (or turn OFF) a jumper, you remove the clip. Sometimes a jumper consists of a set of three pins, labeled 1, 2, and 3. In this case you connect either pins 1 and 2, or 2 and 3. A pair of needle-nose pliers may be useful when setting jumpers.

1.8.2 CMOS Clear (CMOS1)

The AIMB-285 motherboard contains a jumper that can erase CMOS data and reset the system BIOS information. Normally this jumper should be set with pins 1-2 closed. If you want to reset the CMOS data, set J1 to 2-3 closed for just a few seconds, and then move the jumper back to 1-2 closed. This procedure will reset the CMOS to its default setting.

Table 1.3: CMOS1

Function	Jumper Setting
*Keep CMOS data	 1-2 closed
Clear CMOS data	 2-3 closed

* Default

1.8.3 Power Switch/HDD LED/SMBUS/Speaker Pin Header (JFP1)

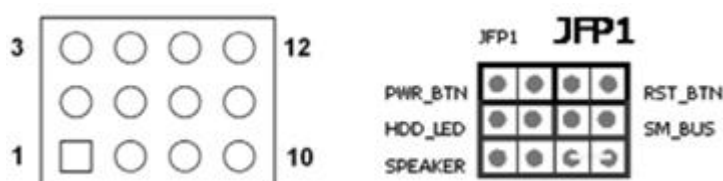

Table 1.4: Power Switch/HDD LED/SMBUS/Speaker Pin Header(JFP1)

Pin	Signal	Pin	Signal
1	+5V	2	HDDLED+
3	Power Button+	4	NC
5	HDDLED-	6	Power Button-
7	SPK_P3	8	SMB_DATA
9	System Reset+	10	SPK_P4
11	SMB_CLK	12	System Reset-

1.8.4 Power LED and Keyboard Lock Pin Header (JFP2)

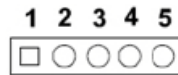

Table 1.5: Power LED and keyboard Lock Pin Header(JFP2)

Pin	Signal
1	LED Power
2	NC
3	GND
4	Keyboard LOCK#
5	GND

1.8.5 Watchdog Timer Output and OBS Beep (JWDT1+JOBS1)

Table 1.6: Watchdog Timer Output and OBS Beep (JWDT1+JOBS1)

Function	Jumper Setting
Watchdog Timer Output(2-3) (Default) OBS BEEP(4-5) (Default)	 (4 and 6)+(8 and 9)
Watchdog Timer Disable (1-2) OBS BEEP(4-5) (Default)	 (1 and 2)+(8 and 9)

1.8.6 ATX, AT Mode Selection (PSON2)

Table 1.7: PSON2: ATX, AT Mode Selector

Closed Pins	Result
1-2 AT mode	 1-2 closed
2-3* ATX mode	 2-3 closed

*Default

1.8.7 LVDS Panel Voltage Selection (JLVDS1)

Table 1.8: LVDS Panel Voltage Selection (JLVDS1)

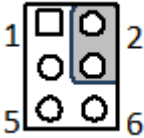
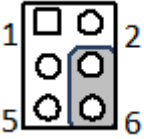
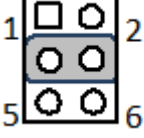
Function	Jumper Setting
Jumper position for 5V	 JLVDS1(2-4)
Jumper position for 3.3V (Default)	 JLVDS1(4-6)
Jumper position for 12V	 JLVDS1(3-4)

1.8.8 COM2 RI# pin RI#/5V/12V Select (JSETCOM2_V1)

Table 1.9: COM2 RI# pin RI#/5V/12V Select (JSETCOM2_V1)

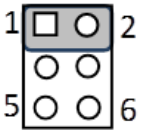
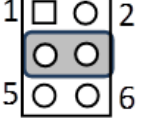
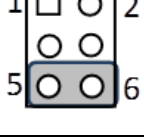
Function	Jumper Setting
Jumper position for RI# (Default)	 1 and 2
Jumper position for 5V	 3 and 4
Jumper position for 12V	 5 and 6

1.9 System Memory

AIMB-285 has two sockets for a 260-pin DDR4 SODIMM. This socket uses a 1.2 V unbuffered double data rate synchronous DRAM (DDR SDRAM). DRAM is available in capacities of 2 GB, 4 GB, 8 GB and 16 GB. The sockets can be filled in any combination with SODIMMs of any size, giving a total memory size between 2 GB, 4 GB, 8 GB, and 16 GB. AIMB-285 does NOT support ECC (error checking and correction).

1.10 Memory Installation Procedures

To install SODIMMs, first make sure the handle of the SODIMM socket are in the “open” position, i.e., the handles lean outward. Slowly slide the SODIMM module along the plastic guides on both ends of the socket. Then press the SODIMM module well down into the socket, until you hear a click when the two handles have automatically locked the memory module into the correct position of the SODIMM socket. To remove the memory module, just push both handles outward, and the memory module will be ejected by the mechanism.

1.11 Cache Memory

The AIMB-285 supports a CPU with one of the following built-in full speed Last Level Cache:

8MB for Intel Core i7-6700

8MB for Intel Core i7-6700TE

6MB for Intel Core i5-6500

6MB for Intel Core i5-6500TE

3MB for Intel Core i3-6100

3MB for Intel Core i3-6100TE

3MB for Intel Pentium G4400

3MB for Intel Pentium G4400TE

2MB for Intel Celeron G3900

2MB for Intel Celeron G3900TE

The built-in second-level cache in the processor yields much higher performance than conventional external cache memories.

1.12 Processor Installation

The AIMB-285 is designed for Intel 6th Gen LGA1151, core i7/i5/i3/Pentium/Celeron processor.

Chapter 2

Connecting
Peripherals

2.1 Introduction

You can access most of the connectors from the top of the board as it is being installed in the chassis. If you have a number of cards installed or have a packed chassis, you may need to partially remove the card to make all the connections.

2.2 LAN Ports & USB Ports (LAN1/ LAN12/USB312/ USB334/USB56/USB78)

The AIMB-285 provides up to ten USB ports. Four USB3.0 on the rear side and four pin header on the board and other two on Mini PCIE connector.

The USB interface complies with USB Specification Rev. 2.0 and Rev. 3.0 supporting transmission rates up to 625 Mbps and is fuse protected.

The USB interface can be disabled in the system BIOS setup.

The AIMB-285 is equipped with two high-performance 1000 Mbps Ethernet LAN adapter, which are supported by all major network operating systems. The RJ-45 jacks on the rear panel provides for convenient LAN connection.

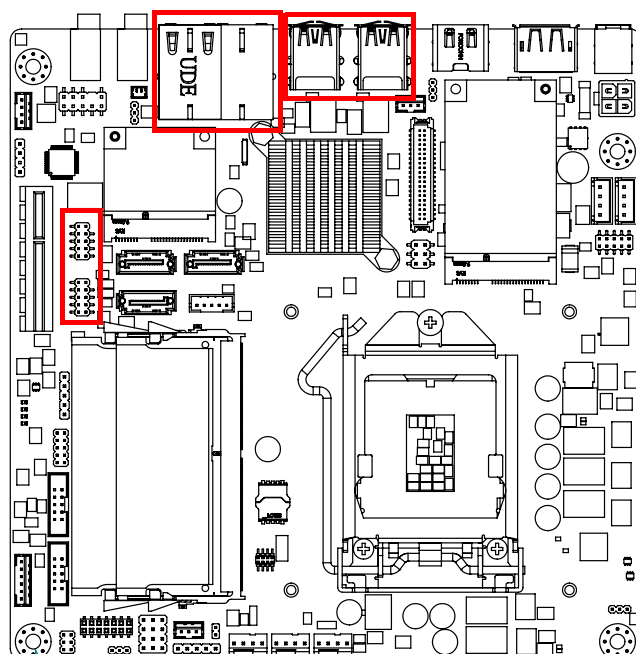
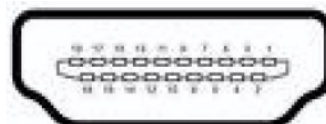
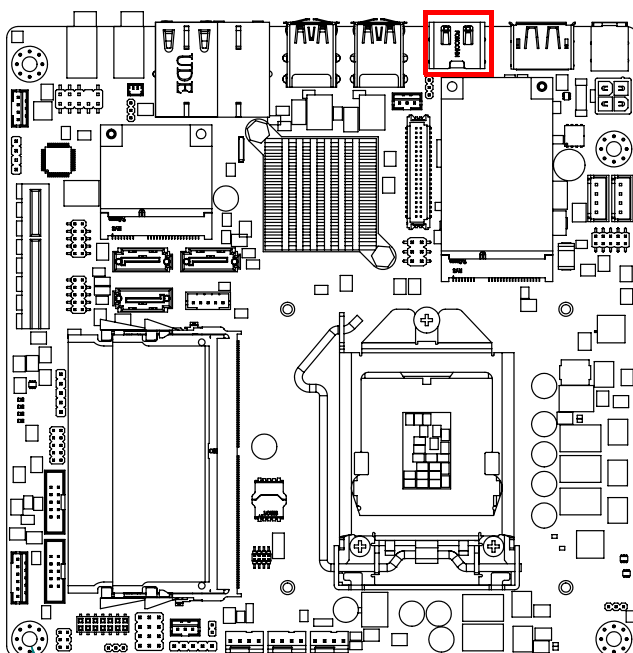

Table 2.1: LAN LED Indicator

LAN Mode	LAN Indicator	
LAN1 indicator	LED1 (Right)	off for mal-link; Link (On) / Active (Flash)
	LED2 (Left)	100 Mbps (On) / 10 Mbps (Off)
	LED2 (Left)	1000 Mbps (On)
LAN2 indicator	LED1 (Right)	off for mal-link; Link (On) / Active (Flash)
	LED2 (Left)	100 Mbps (On) / 10 Mbps (Off)
	LED2 (Left)	1000 Mbps (On)

2.3 High Definition Multimedia Interface Connector(HDMI1)



The AIMB-285 includes HDMI interface that can drive conventional HDMI displays. HDMI1 is a standard 19-pin HDMI connector commonly used for HDMI.

2.4 Display Port (DP1)

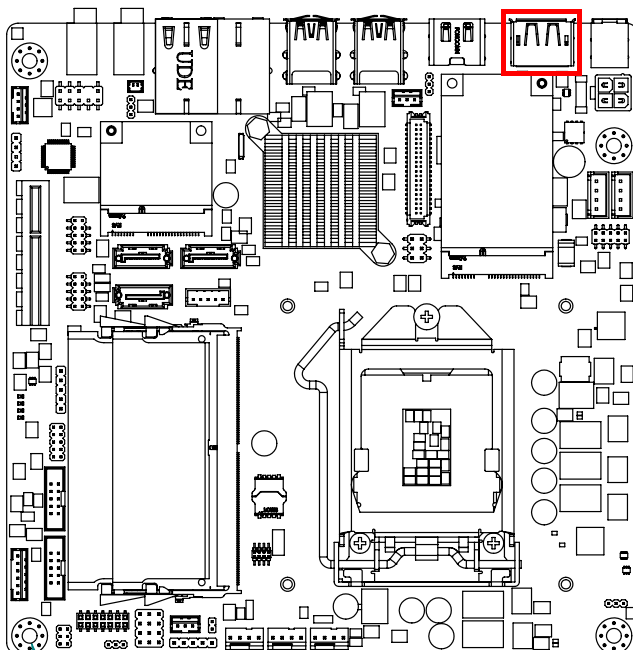

The AIMB-285 includes DP interface that can drive conventional DP displays. DP1 is a standard 20-pin DP connector commonly used for DP.

2.5 PS/2 Keyboard and Mouse Connector (KBMS1)

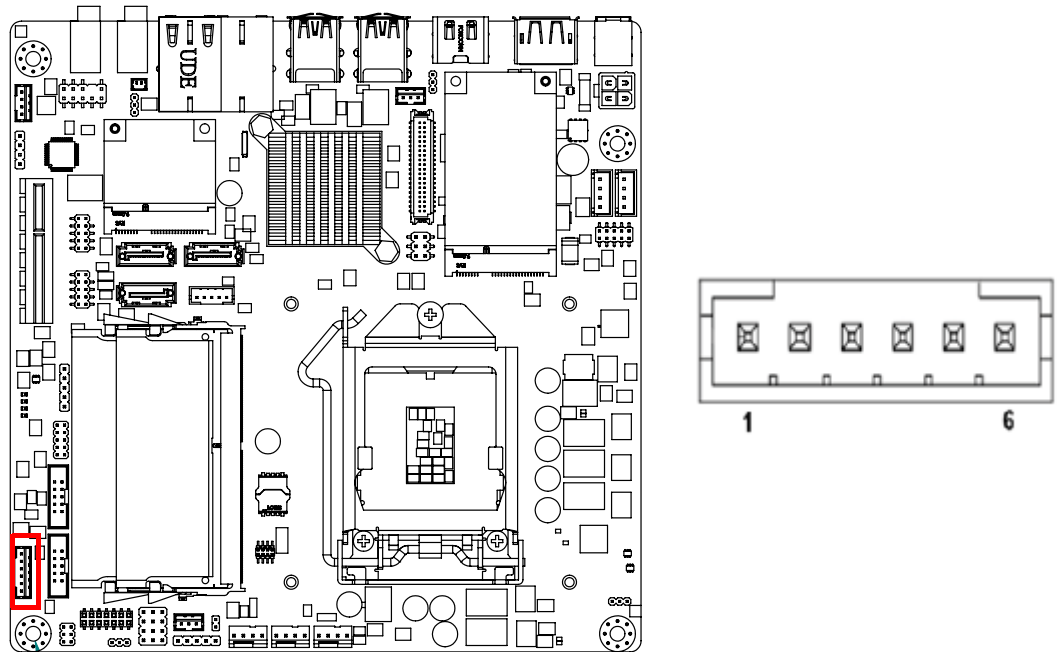

On board 6-pin wafer box connector, supports one standard PS/2 keyboard, one standard PS/2 mouse.

2.6 CPU Fan Connector (CPU_FAN1)

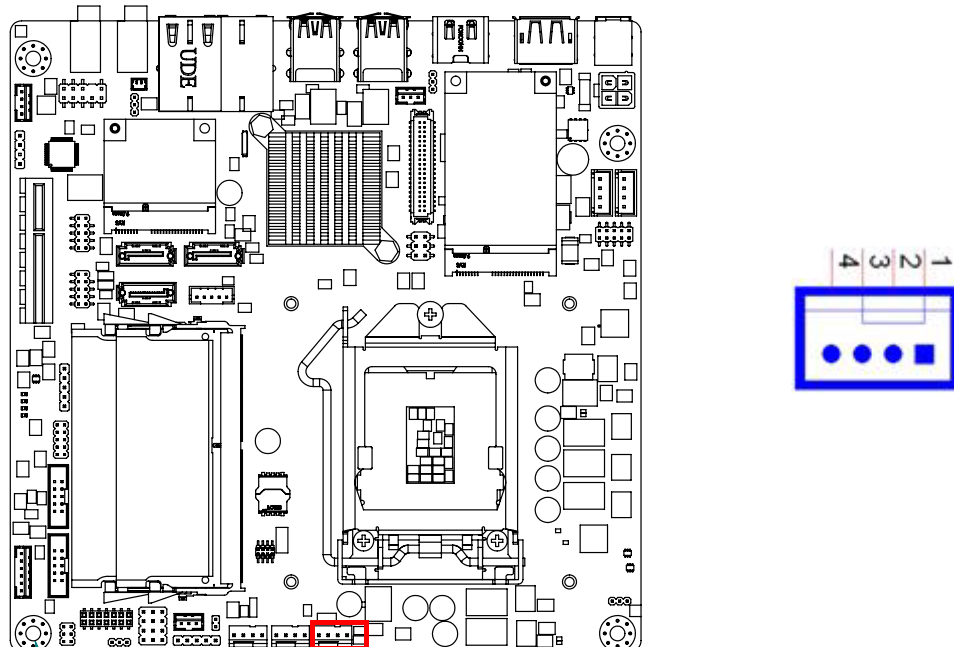

If a fan is used, this connector supports cooling fans of 500 mA (6 W) or less.

2.7 System FAN Connector (SYSFAN1)

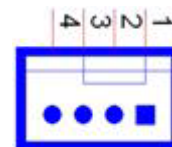
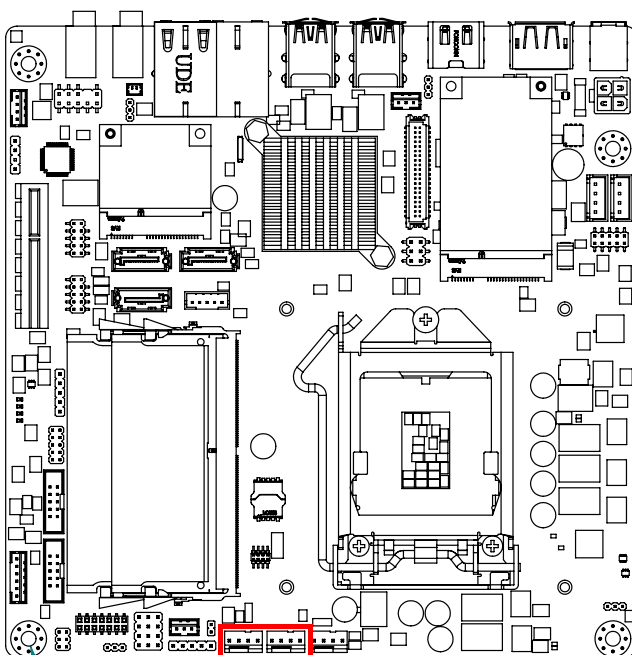

If a fan is used, this connector supports cooling fans of 500 mA (6 W) or less.

2.8 Power Switch/HDD LED/SMBUS/Speaker Pin Header (JFP1) & Power LED and Keyboard Lock Pin Header (JFP2)

There are several headers for monitoring and controlling the AIMB-285.

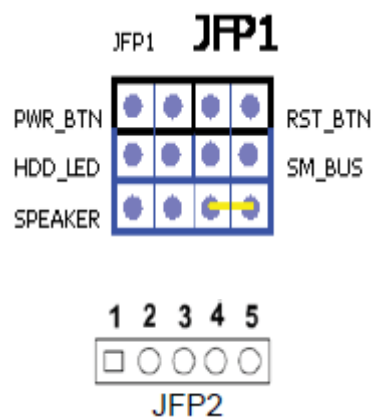
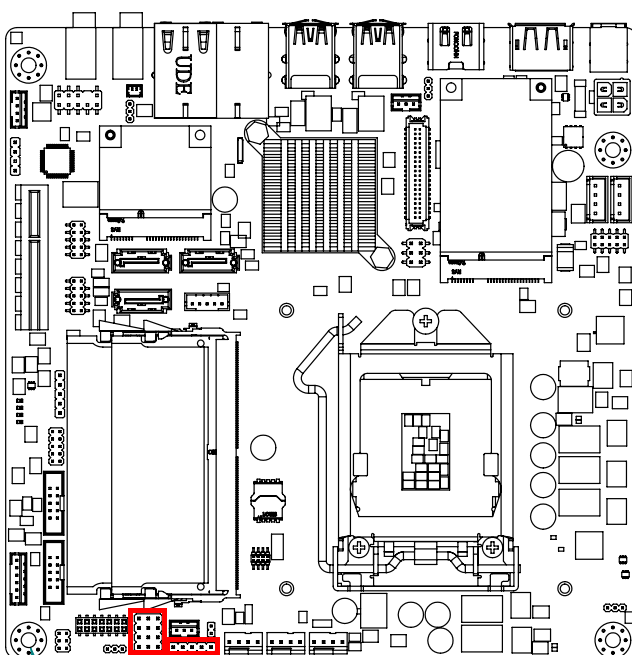

2.8.1 ATX soft power switch (JFP1/PWR_SW)

If your computer case is equipped with an ATX power supply, you should connect the power on/off button on your computer case to (JFP1/ PWR_SW), for convenient power on and off.

2.8.2 Reset (JFP1/RESET)

Many computer cases offer the convenience of a reset button. Connect the wire for the reset button.

2.8.3 HDD LED (JFP1/HDDLED)

You can connect an LED to connector (JFP1/HDDLED) to indicate when the HDD is active.

2.8.4 External speaker (JFP1/SPEAKER)

JFP1/SPEAKER is a 4-pin connector for an external speaker. If there is no external speaker, the AIMB-285 provides an onboard buzzer as an alternative. To enable the buzzer, set pins 7 & 10 as closed.

2.8.5 Power LED and keyboard lock connector (JFP2/PWR_LED & KEY LOCK)

(JFP2/PWR_LED & KEY LOCK) is a 5-pin connector for the power on LED and Key Lock function. Refer to Appendix B for detailed information on the pin assignments.

The Power LED cable should be connected to pin 1-3. The key lock button cable should be connected to pin 4-5. There are 3 modes for the power supply connection.

The first is “ATX power mode”; the system turns on/off by a momentary power button.

The second is “AT Power Mode”; the system turns on/off via the power supply switch.

The third is another “AT Power Mode” which makes use of the front panel power switch. The power LED status is indicated in the following table:

Table 2.2: ATX power supply LED status (No support for AT power)

Power mode	LED (ATX Power Mode) (On/off by momentary button)	LED (AT power Mode) (On/off by switching power supply)	LED (AT power Mode) (On/off by front panel switch)
PSON2 (on back plane) jumper setting	pins 2-3 closed	pins 1-2 closed	Connect pins 1 & 2 to panel switch via cable
System On	On	On	On
System Off	Off flashes (windows 7) Slow flashes (windows 8.1)	Off	Off
System Suspend(S3)	Fast flashes	NA	NA
System Suspend(S4)	Slow flashes	NA	NA

2.9 SATA Signal Connector (SATA1 ~ SATA3)

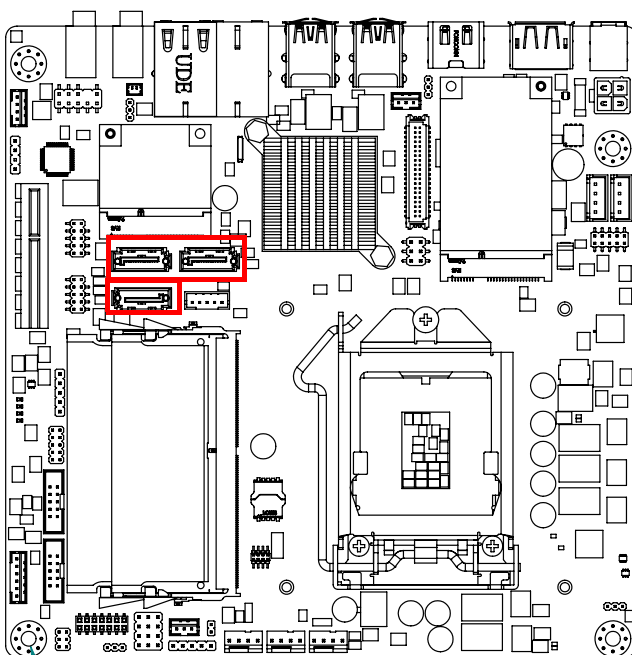

AIMB-285 features a high performance Serial ATA III interface (up to 600 MB/s) which eases hard drive cabling with thin, space-saving cables.

2.10 SATA_PWR1/2

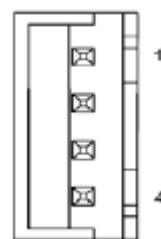
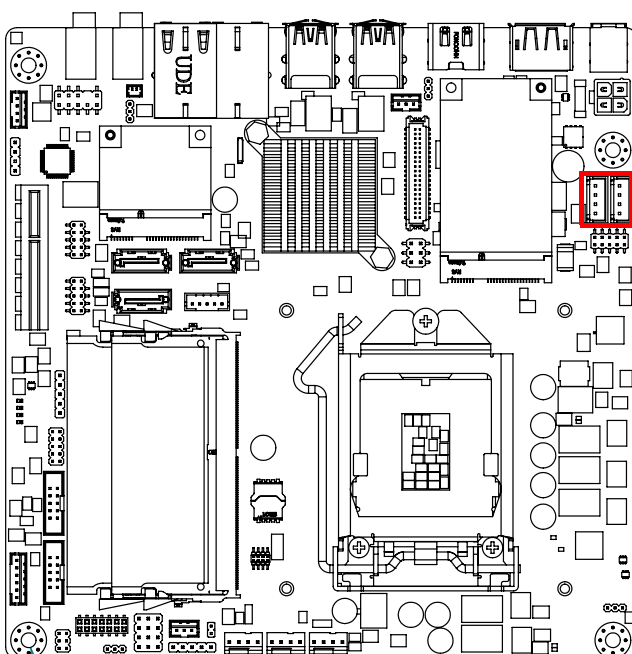

2.11 HD Analog Audio Interface (AUDIO1,AUDIO2, FPAUD1)

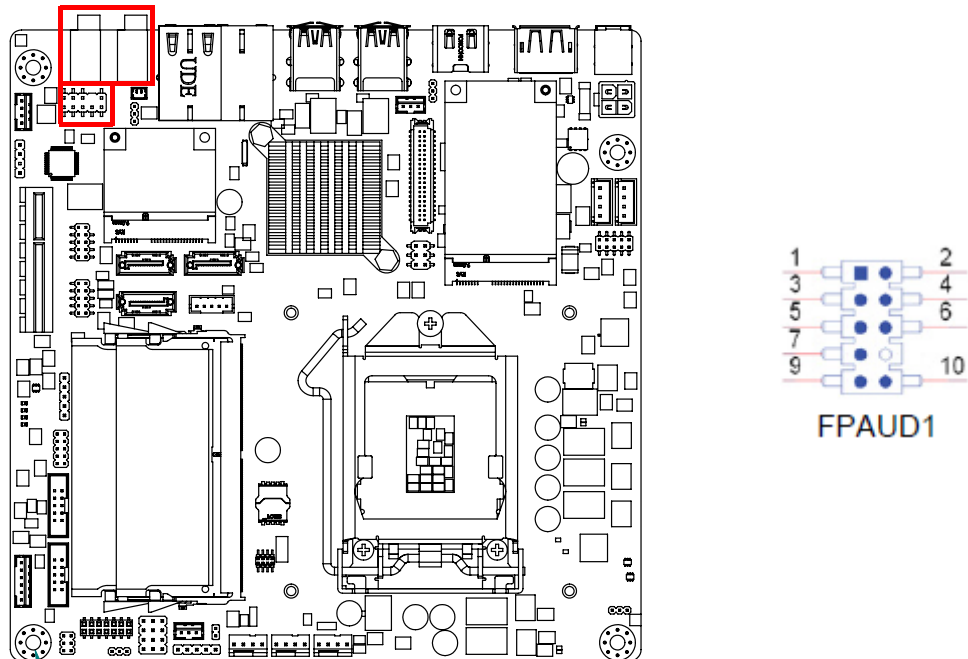

Note! For motherboards with the optional HD Audio feature, we recommend that you connect a high-definition front panel audio module to this connector to take advantage of the motherboard's high definition audio capability



2.12 PCI-E x4 Slot (PCIEX4_1)

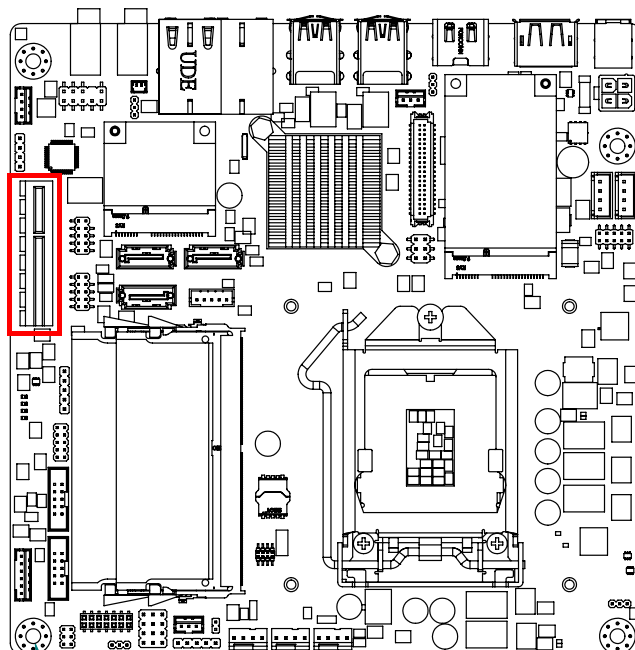

AIMB-285 provides 1x PCI express x4 slot.

2.13 LVDS Panel Connector (LVDS1), BOM optional

The SPI flash card pin header may be used to flash BIOS if the AIMB-285 cannot power on.

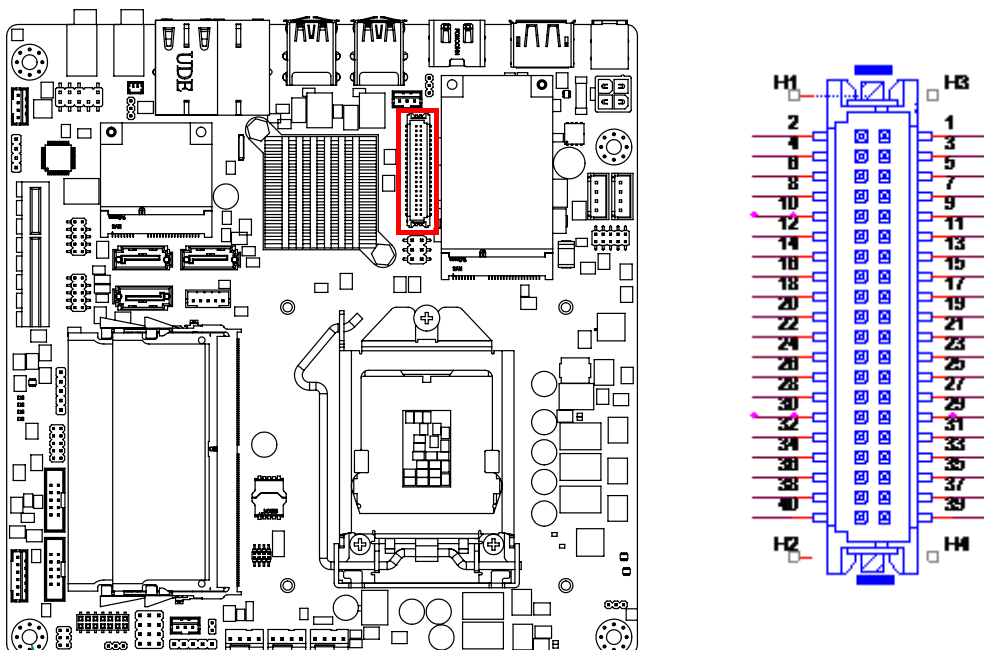

2.14 LVDS Backlight Inverter Power Connector (INV1)

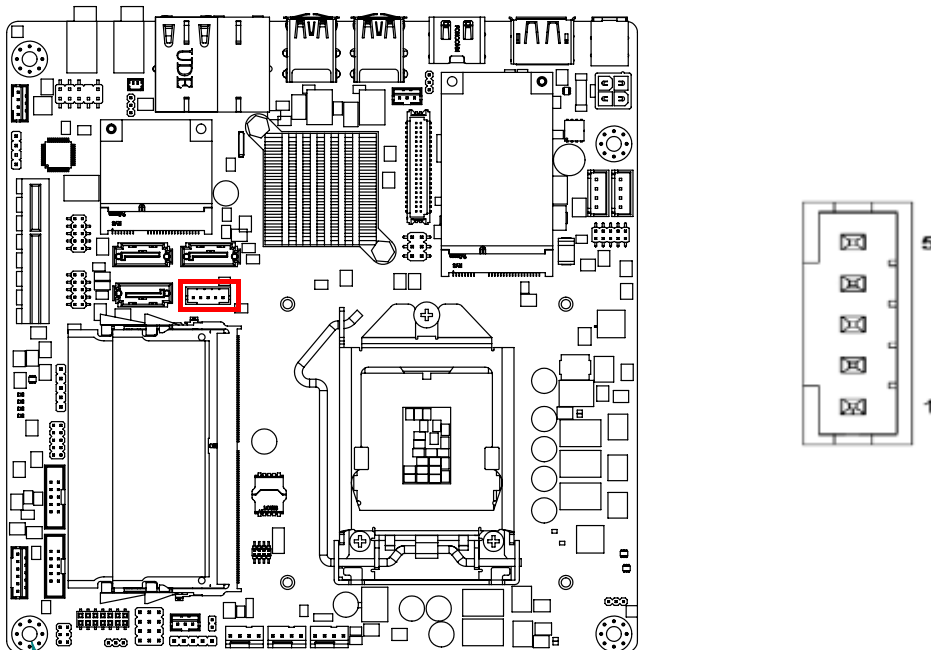

Note!



Signal Description

Signal

VR

ENBKL

Signal Description

Vadj=0.75 V (Recommended: 4.7 K, 1/16 W)

LCD backlight ON/OFF control signal

2.15 MINIPCIE and mSATA Connector (MINIPCIE1)

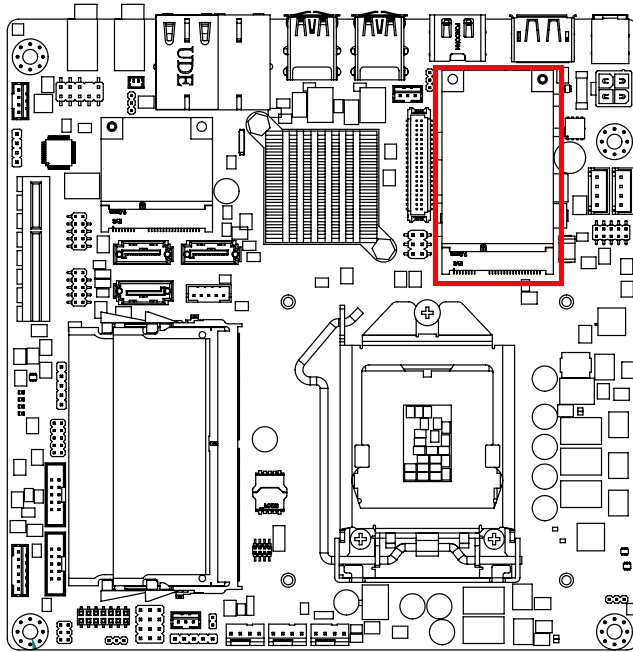

2.16 MINIPCIE Connector (MINIPCIE2) & SIM Card Socket (SIM1)

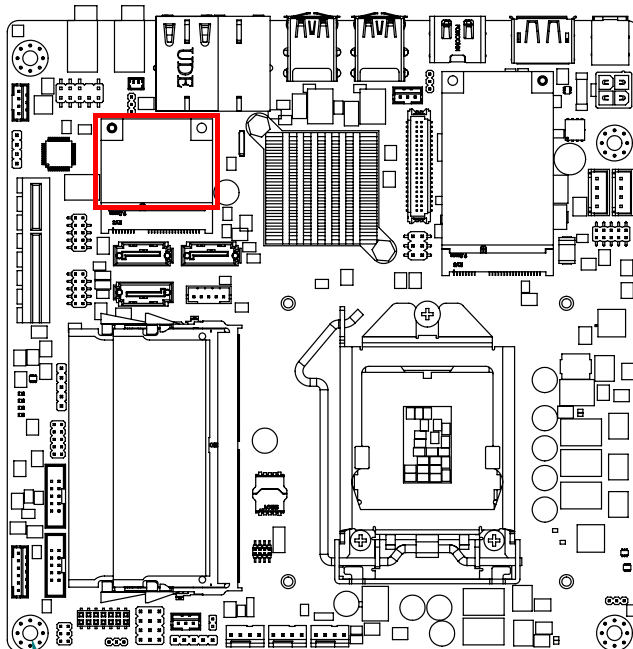

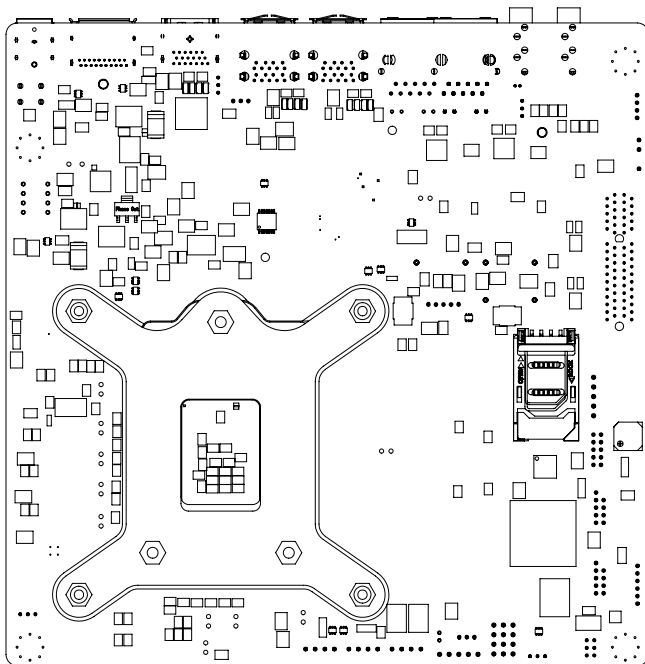

2.17 HD Digital Audio Interface (SPDIF1)

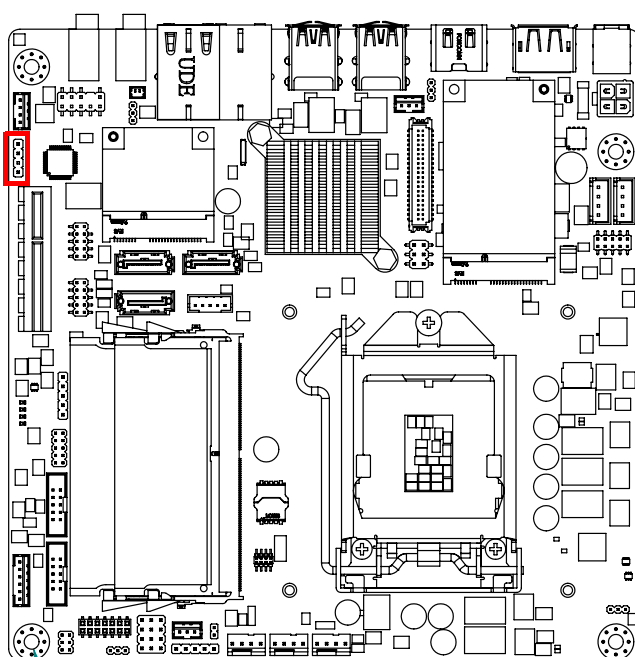

2.18 Audio Amplifier Output Connector (AMP1)

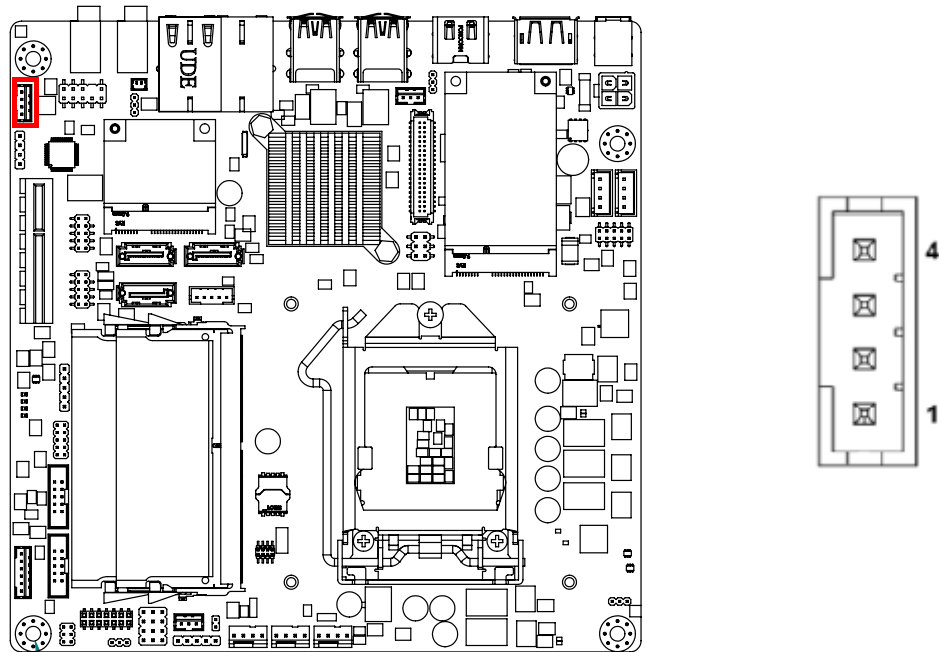

2.19 General purpose I/O Connector (GPIO1)

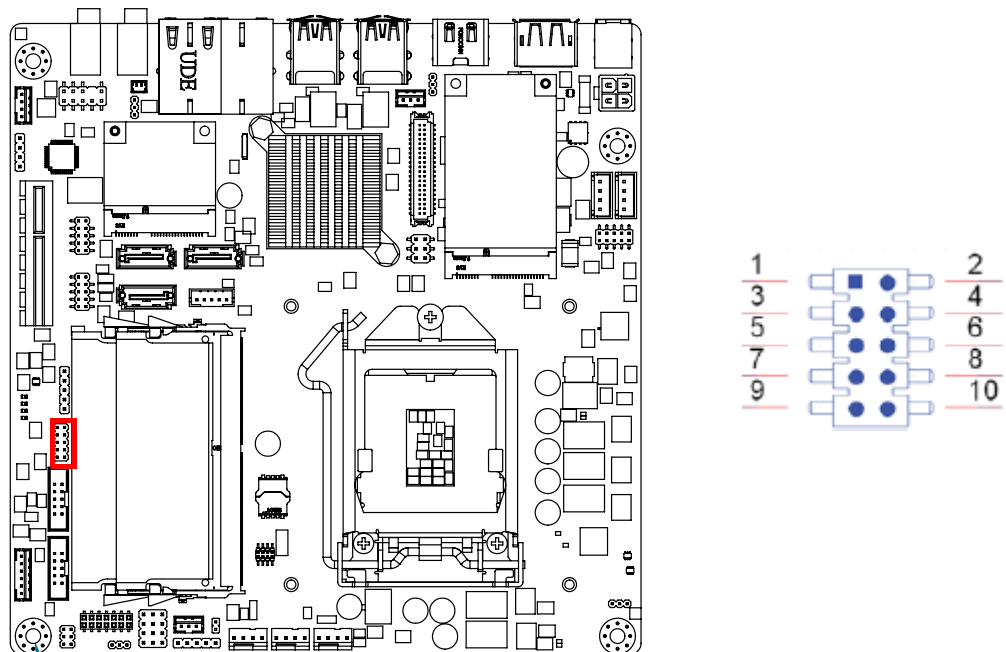

2.20 SPI BIOS Flash Socket (SPI1)

The SPI flash card pin header may be used to flash BIOS if the AIMB-285 cannot power on.

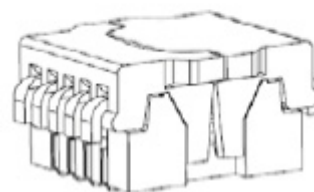
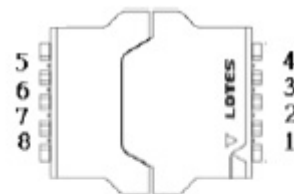
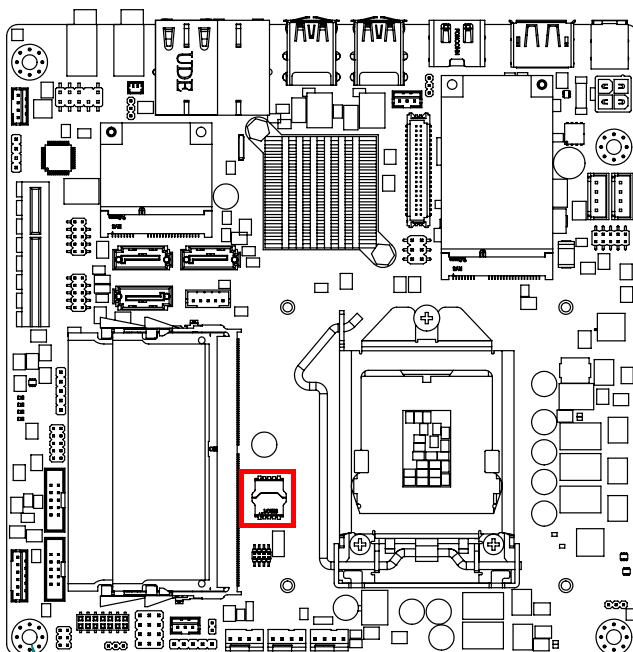

2.21 SPI Programming Pin Header (SPI_CN1)

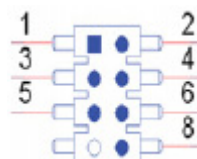
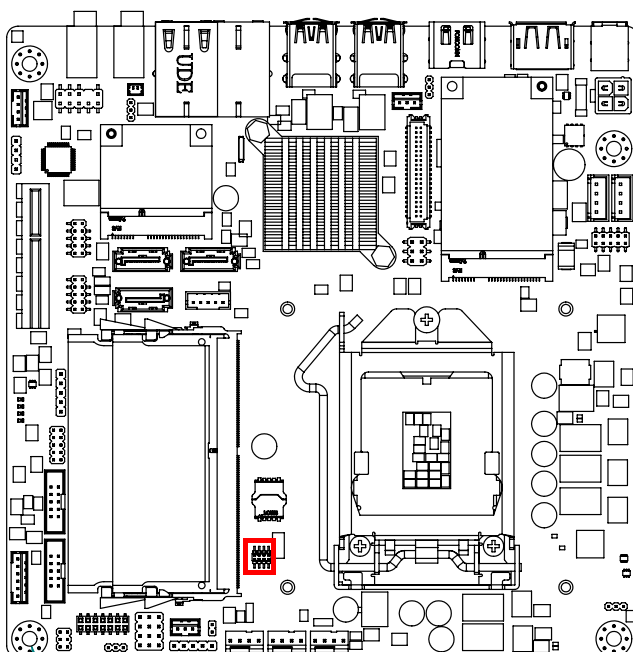

2.22 Low Pin Count Header (LPC1)

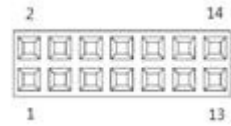
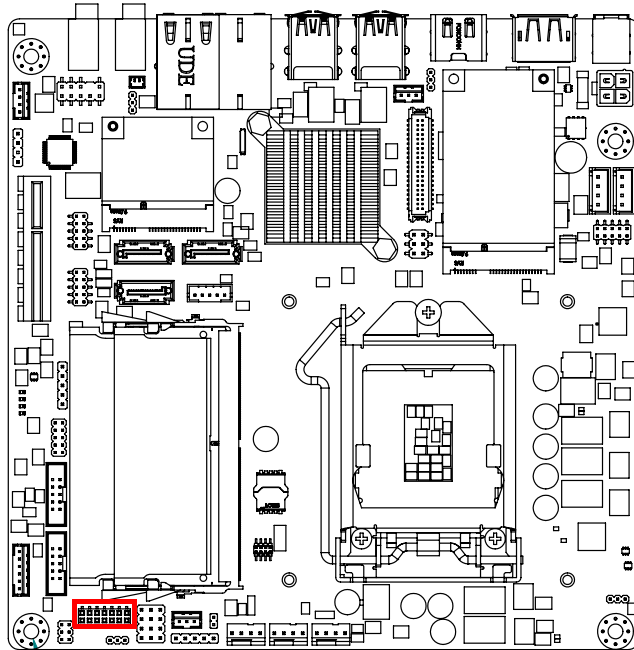

2.23 Case-Open Detect Connector (JCASE1)

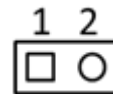
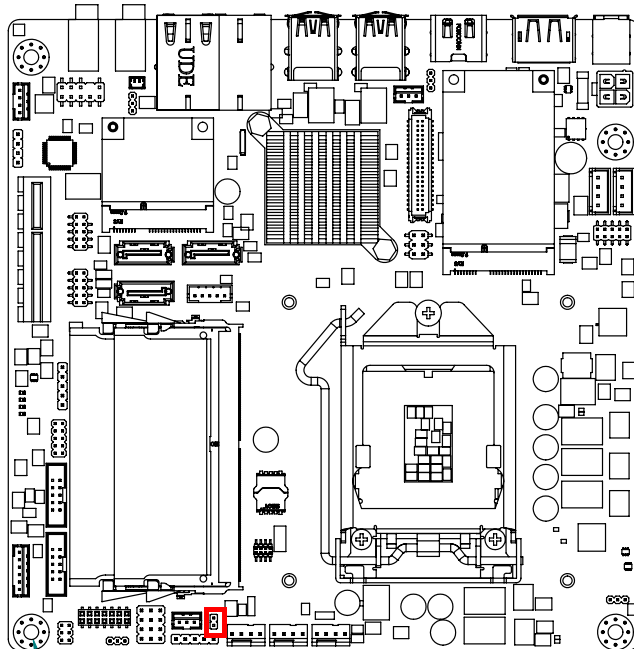

2.24 ATX 12V Power Supply Connector (ATX12V1) & ATX 5V Power Supply Connector (ATX5VSB1)

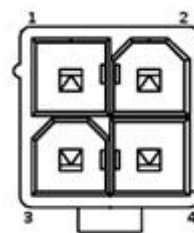
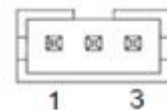
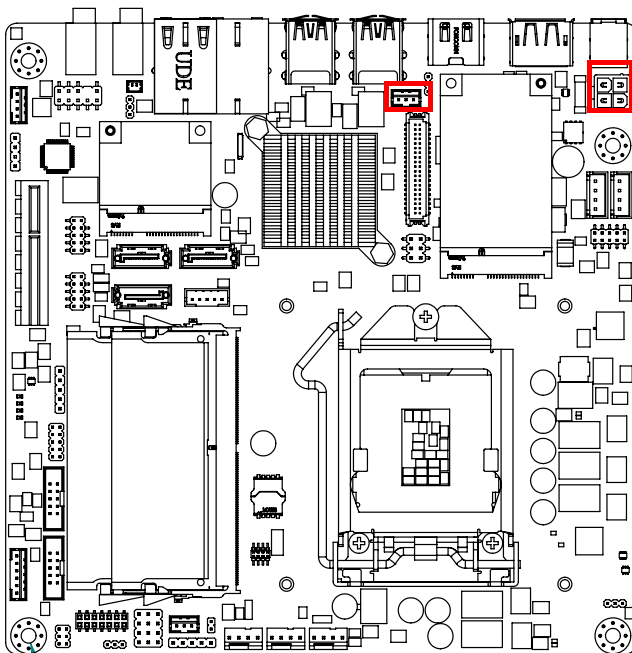

2.25 Battery Header (BAT1)

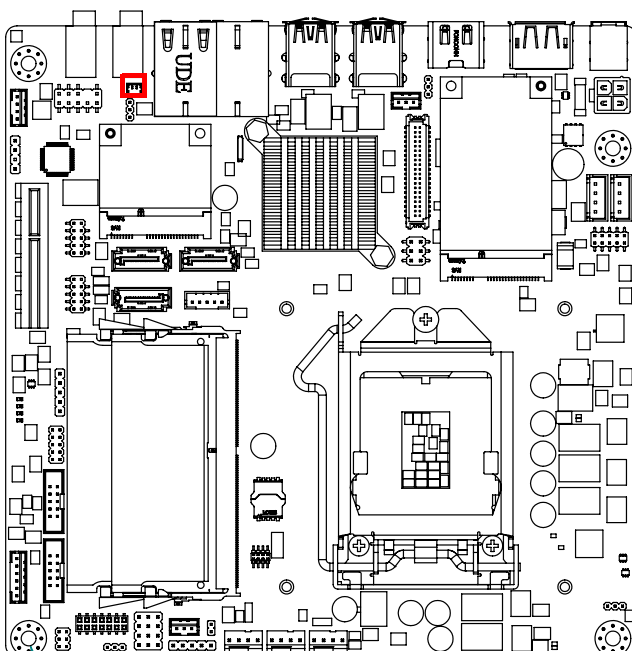

2.26 CPU Socket (CPU1)

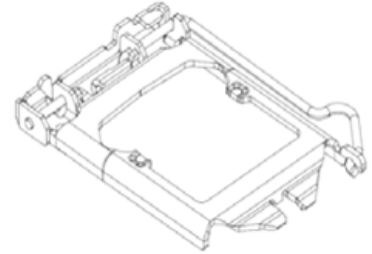
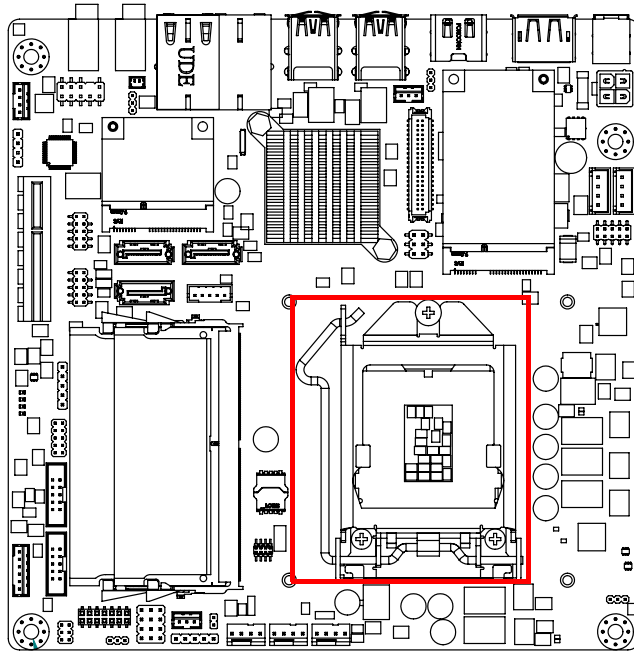

2.27 DDR4 SO-DIMM Socket (DIMMA1, DIMMB1)

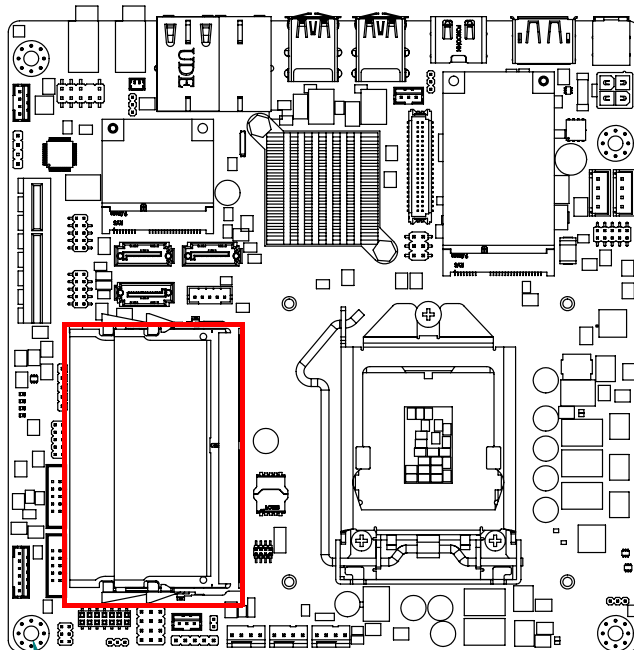

Chapter 3

BIOS Operation

3.1 Introduction

With the AMI BIOS Setup program, you can modify BIOS settings and control the special features of your computer. The Setup program uses a number of menus for making changes and turning special features on or off. This chapter describes the basic navigation of the AIMB-285 setup screens.

3.2 BIOS Setup

The AIMB-285 Series system has AMI BIOS built in, with a CMOS SETUP utility that allows users to configure required settings or to activate certain system features.

The CMOS SETUP saves the configuration in the CMOS RAM of the motherboard. When the power is turned off, the battery on the board supplies the necessary power to preserve the CMOS RAM.

When the power is turned on, press the button during the BIOS POST (Power-On Self Test) to access the CMOS SETUP screen.

Control Keys

< ↑ >< ↓ >< ← >< → >	Move to select item
<Enter>	Select Item
<Esc>	Exit
<Page Up/+>	Increase the numeric value or make changes
<Page Down/->	Decrease the numeric value or make changes
<F1>	General help
<F2>	Previous Values
<F3>	Optimized Defaults
<F4>	Save & Exit

3.2.1 Main Menu

Press to enter AMI BIOS CMOS Setup Utility, the Main Menu will appear on the screen. Use arrow keys to select among the items and press <Enter> to accept or enter the sub-menu.

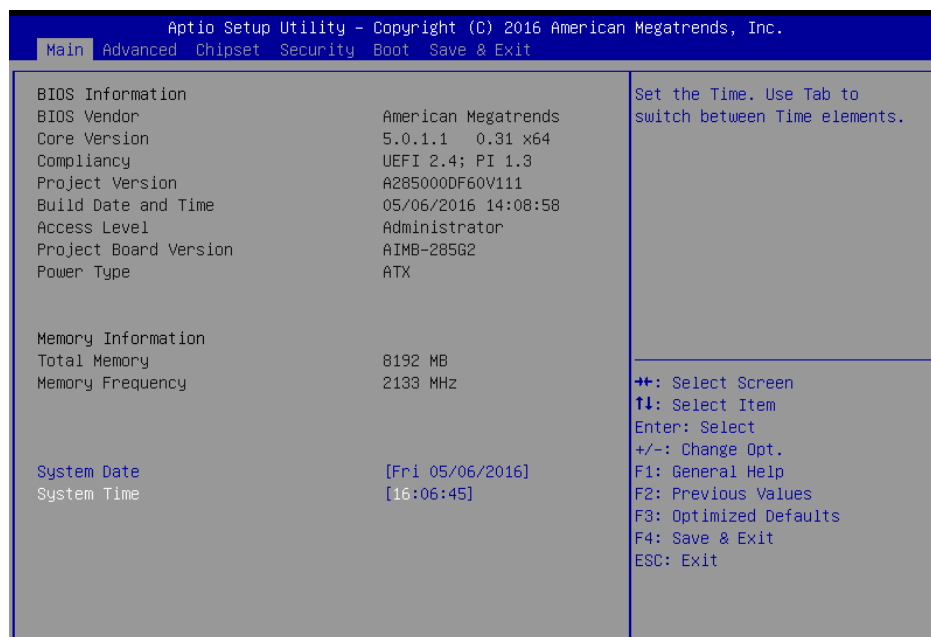

The Main BIOS setup screen has two main frames. The left frame displays all the options that can be configured. Grayed-out options cannot be configured; options in blue can. The right frame displays the key legend.

Above the key legend is an area reserved for a text message. When an option is selected in the left frame, it is highlighted in white. Often a text message will accompany it.

■ System time / System date

Use this option to change the system time and date. Highlight System Time or System Date using the <Arrow> keys. Enter new values through the keyboard. Press the <Tab> key or the <Arrow> keys to move between fields. The date must be entered in MM/DD/YY format. The time must be entered in HH:MM:SS format.

3.2.2 Advanced BIOS Features

Select the Advanced tab from the AIMB-285 setup screen to enter the Advanced BIOS Setup screen. You can select any of the items in the left frame of the screen, such as CPU Configuration, to go to the sub menu for that item. You can display an Advanced BIOS Setup option by highlighting it using the <Arrow> keys. All Advanced BIOS Setup options are described in this section. The Advanced BIOS Setup screen is shown below. The sub menus are described on the following pages.

3.2.2.1 ACPI Settings

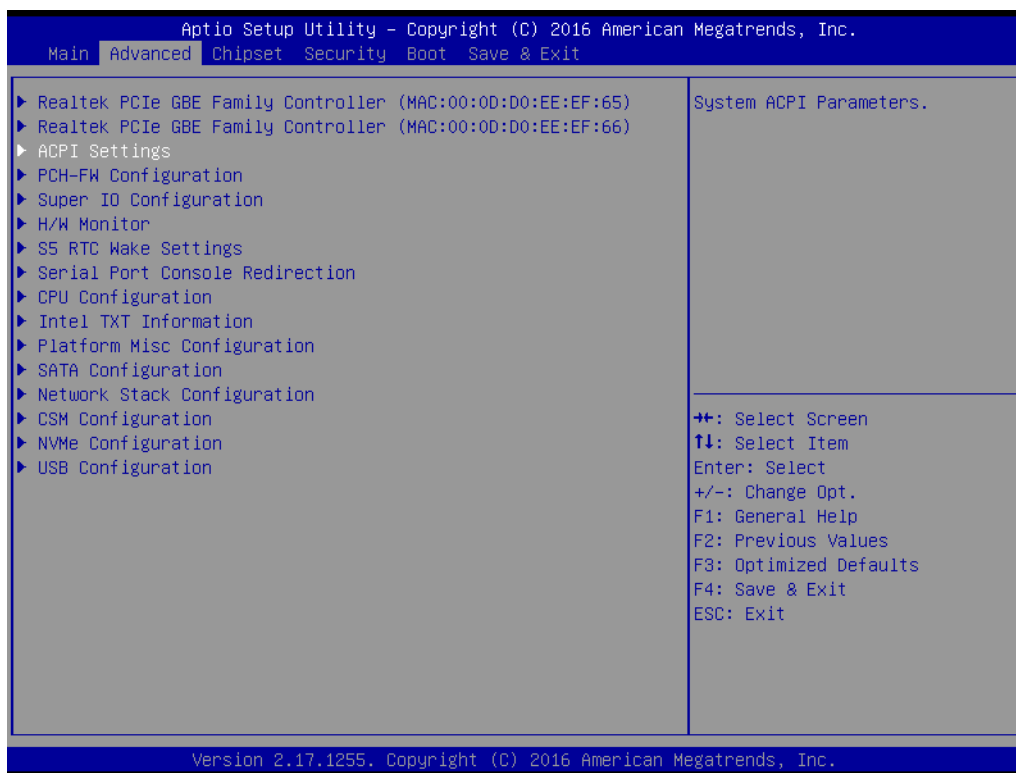

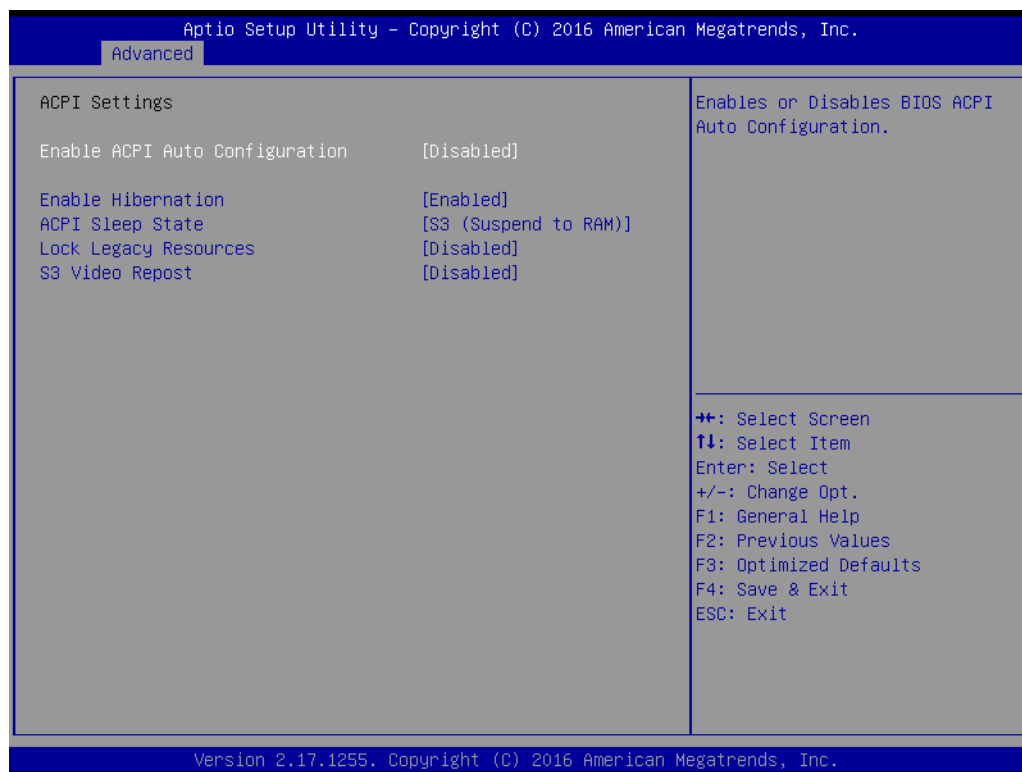

- **Enable ACPI Auto Configuration [Disabled]**
- **Enable Hibernation [Enabled]**
Enables or Disables System ability to Hibernate (OS/S4 Sleep State). This option may be not effective with some OS.
- **ACPI Sleep State [S3 (Suspend to RAM)]**
Select ACPI sleep state the system will enter when the SUSPEND button is pressed.
- **Lock Legacy Resources [Disabled]**
S3 Video Repost [Disabled]

3.2.2.2 PCH-FW Configuration

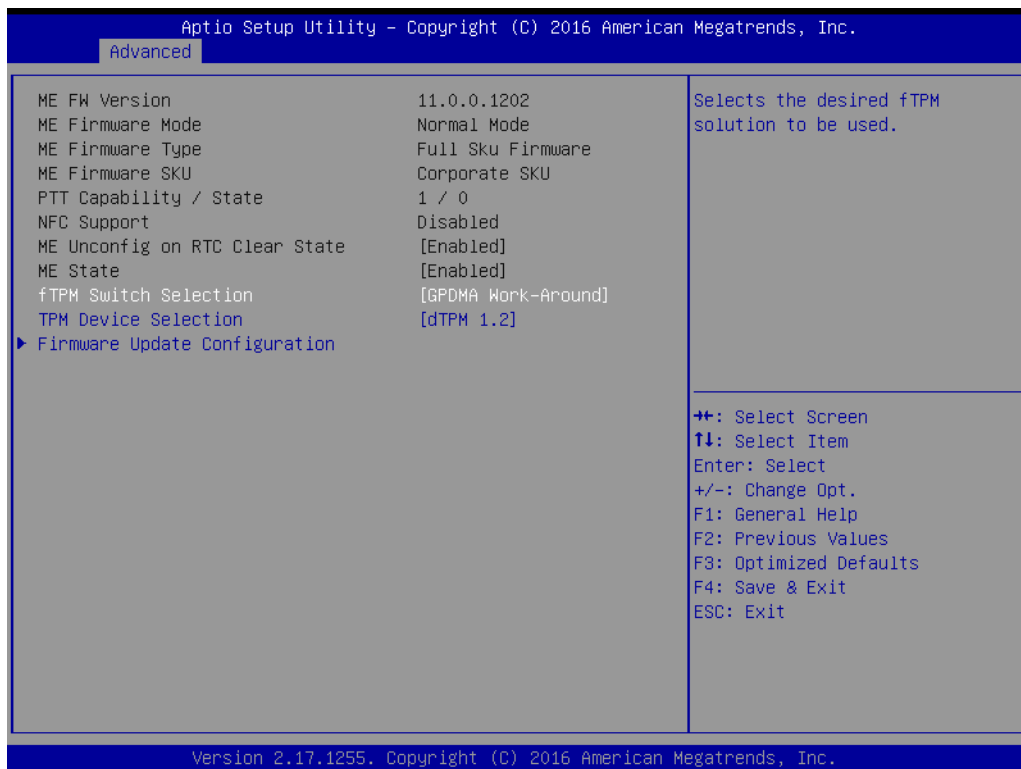
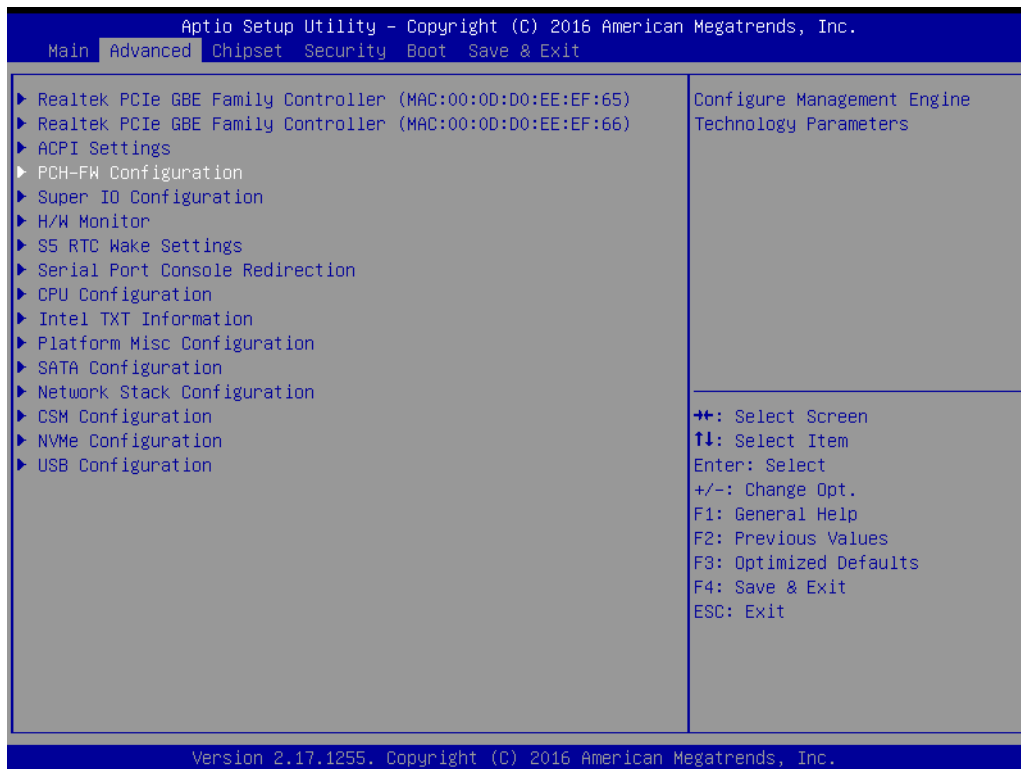

- **ME Unconfig on RTC Clear Status [Enabled]**
- **ME State [Enabled]**

3.2.2.3 Super IO Configuration

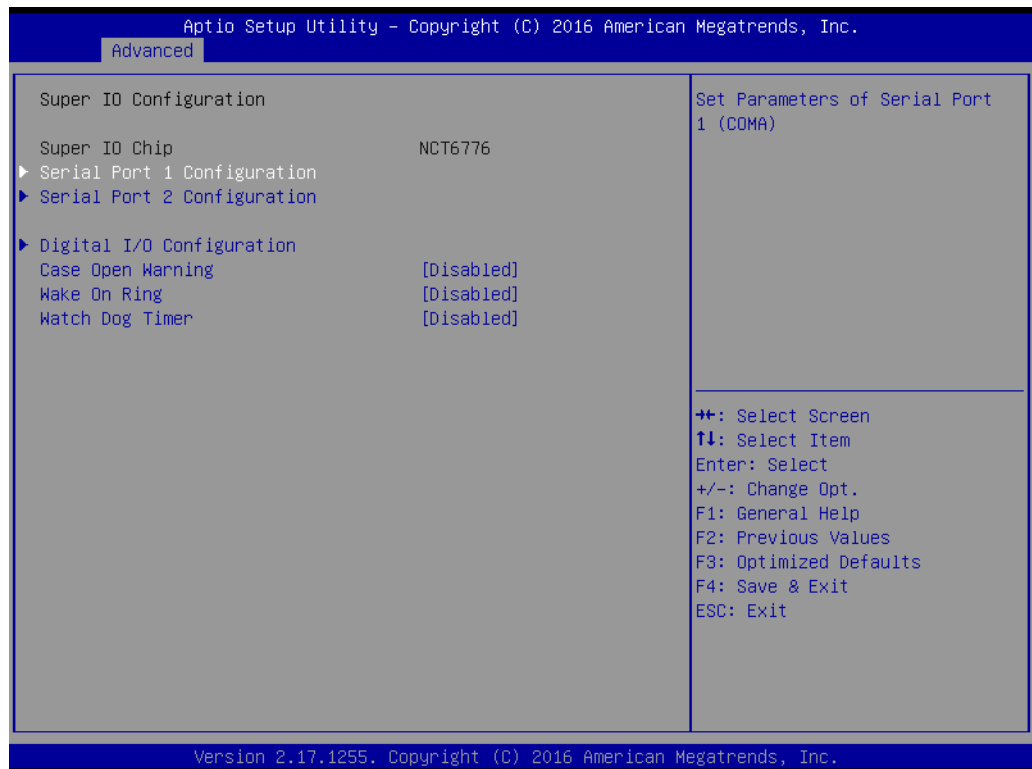
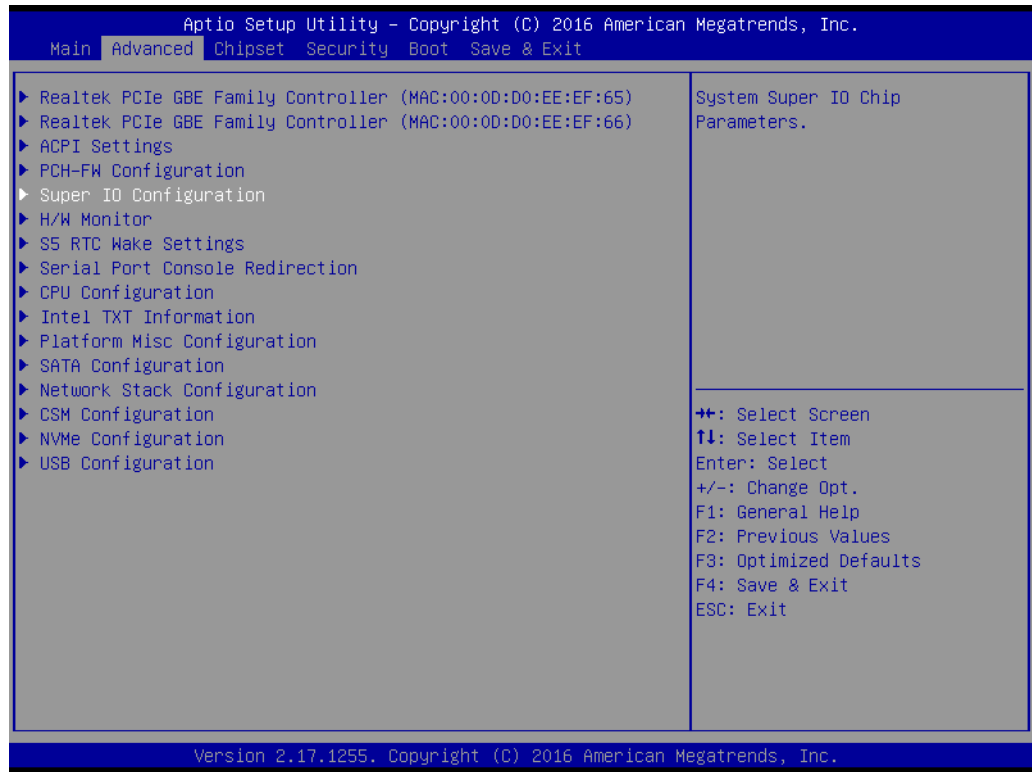

■ Serial Port 1 Configuration

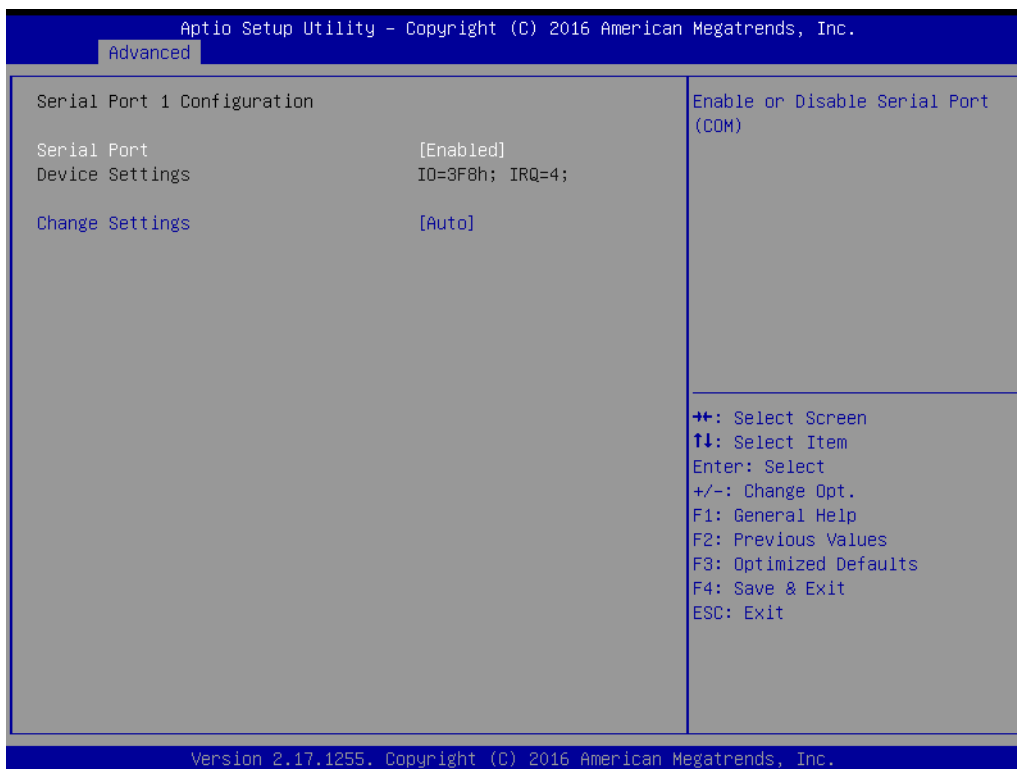

- Serial Port [Enabled]
- Device Settings IO=3F8h; IRQ = 4
- Change Settings [Auto]

■ Serial Port 2 Configuration

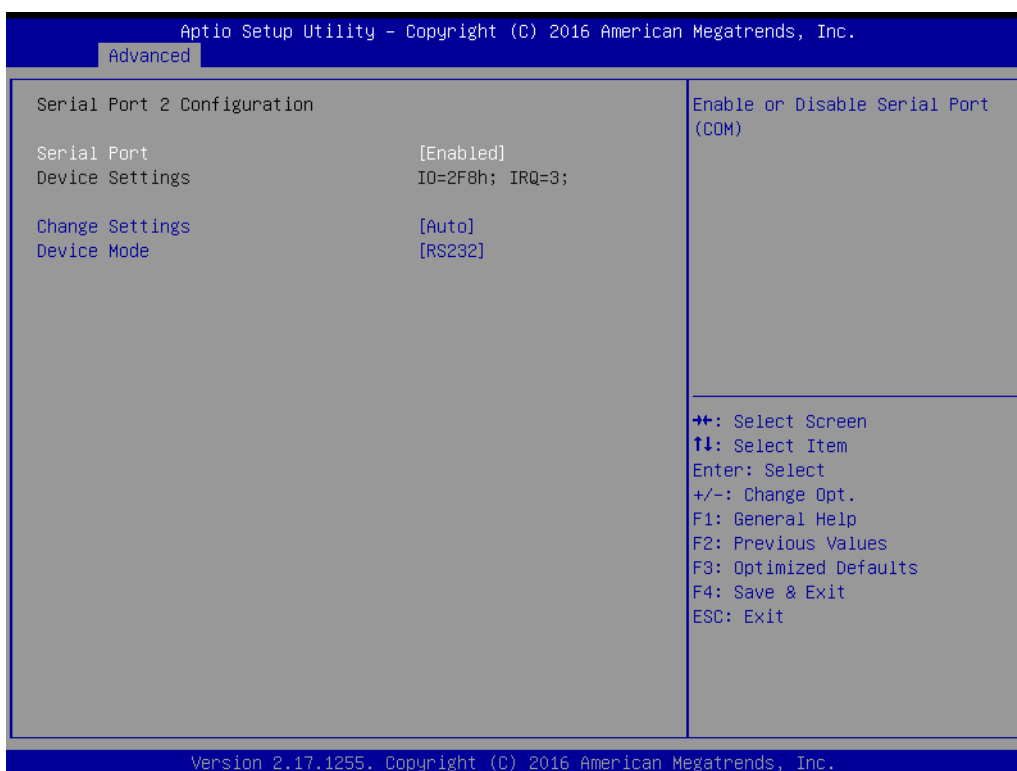

- Serial Port [Enabled]
- Device Settings IO=2F8h; IRQ = 3
- Change Settings [Auto]
- Device Mode [RS232]

■ **Digital I/O Configuration**

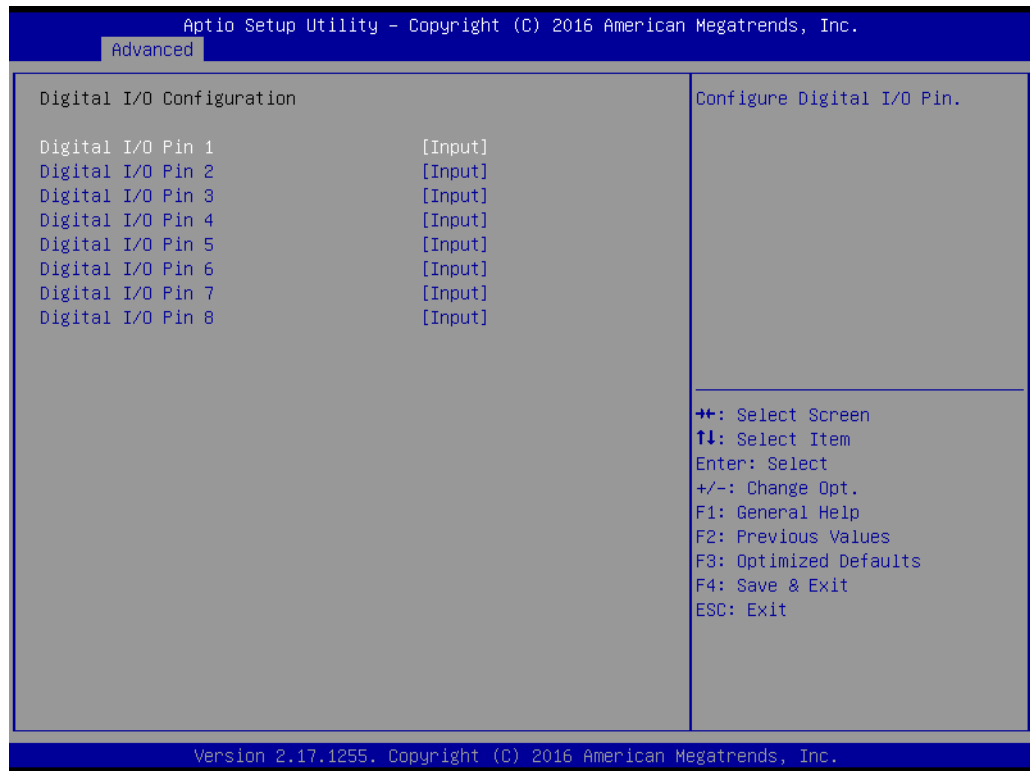

3.2.2.4 H/W Monitor

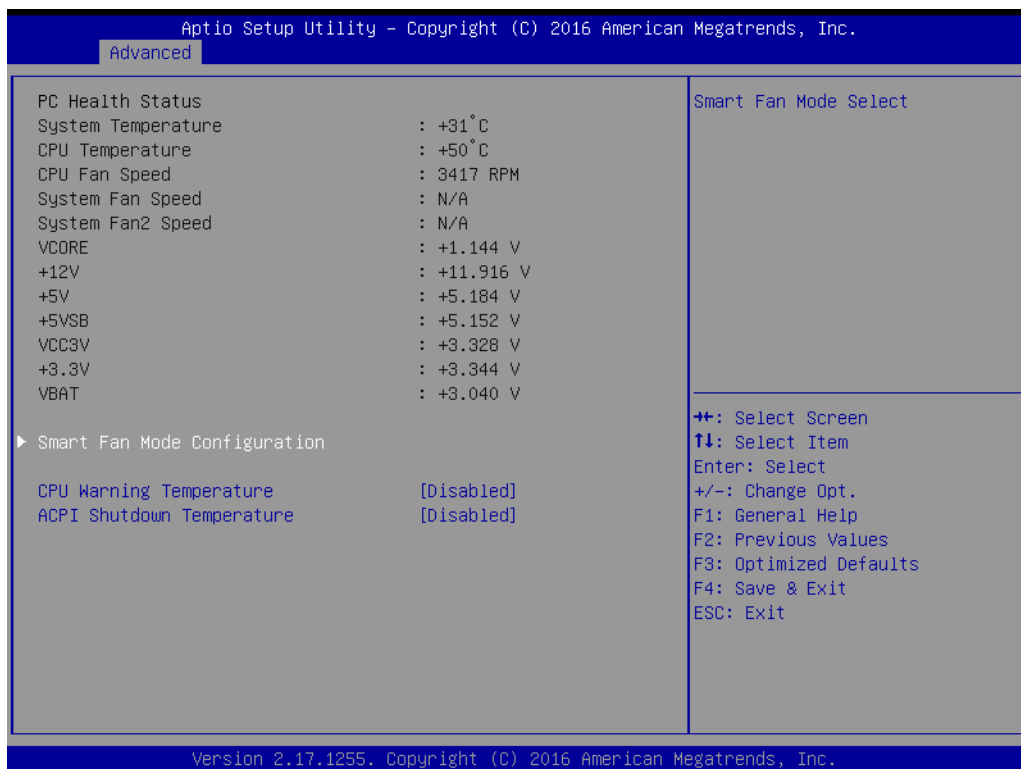
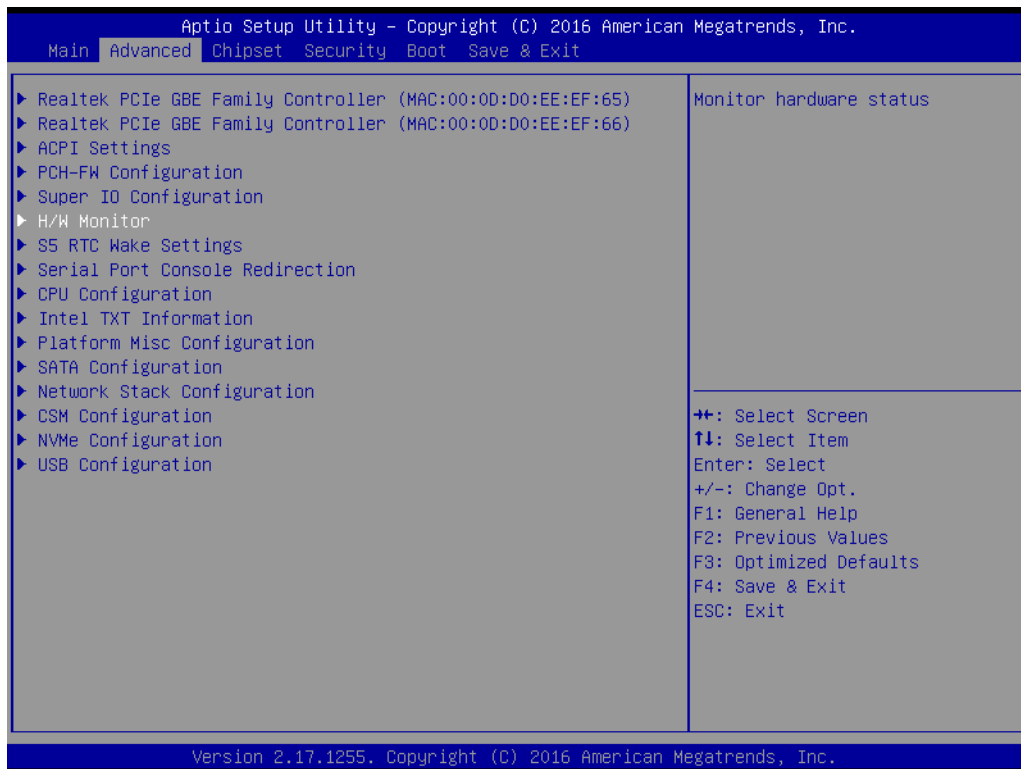

- **CPU Warning Temperature [Disabled]**
 Use this to set the CPU warning temperature threshold. When the system reaches the warning temperature, the speaker will beep.
- **ACPI Shutdown Temperature [Disabled]**

Use this to set the ACPI shutdown temperature threshold. When the system reaches the shutdown temperature, it will be automatically shut down by ACPI OS to protect the system from overheating damage.

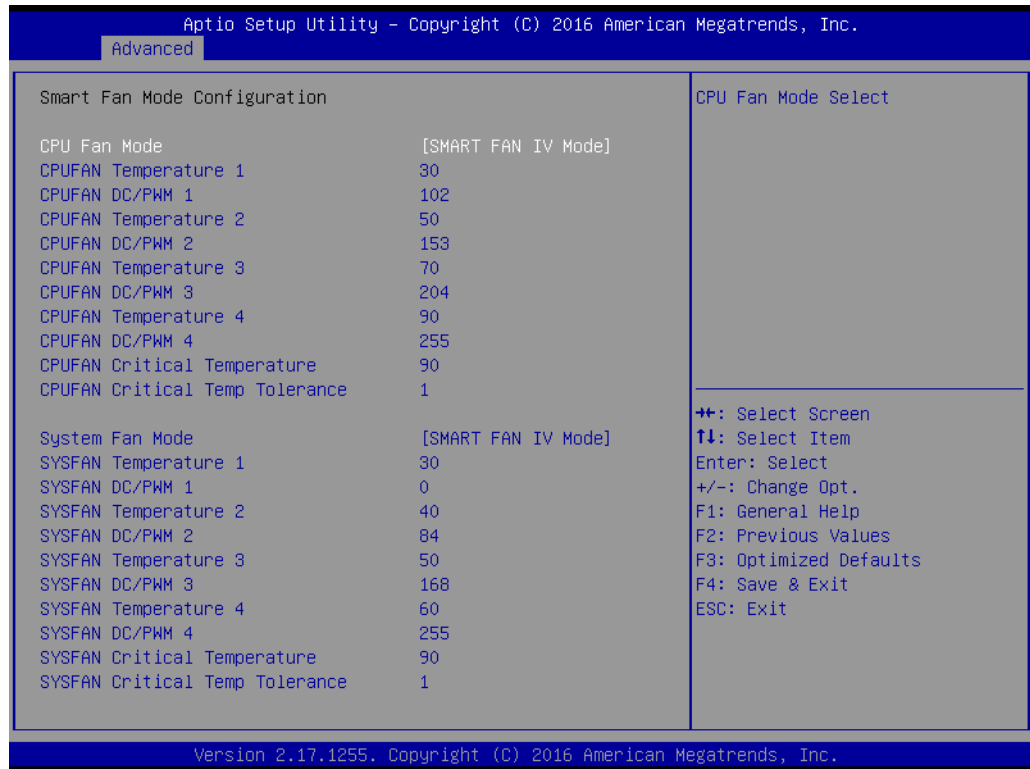

■ **Smart Fan Mode Configuration**

3.2.2.5 S5 RTC Wake Settings

The item allows you enable or disable system wake up on alarm event.

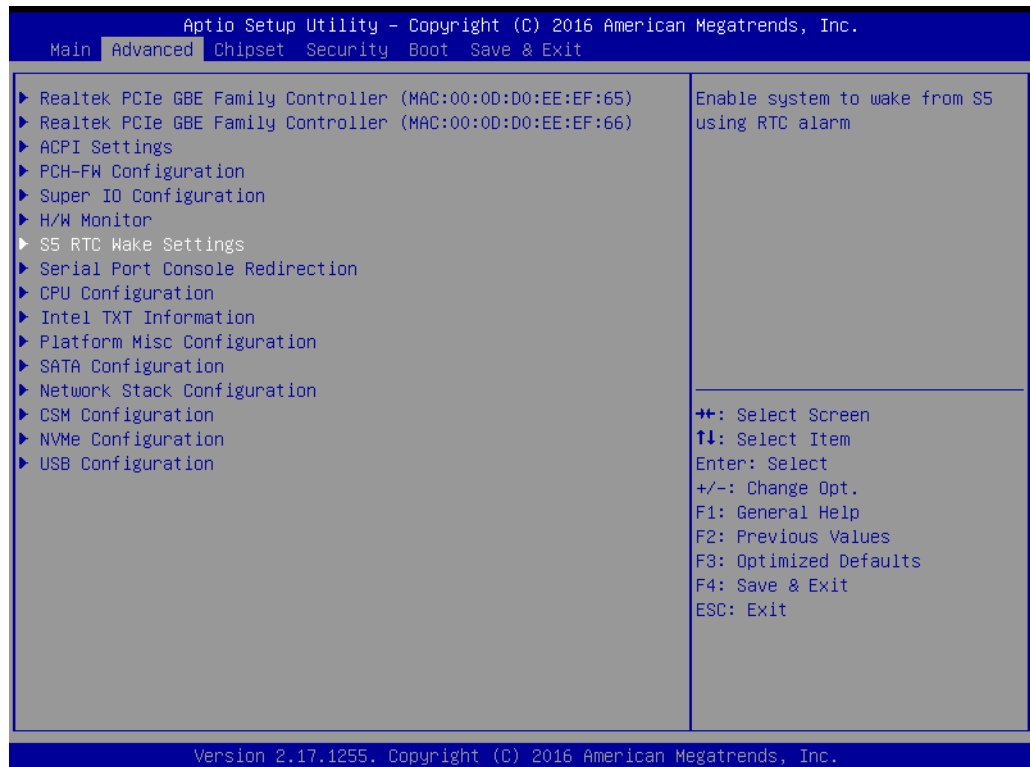

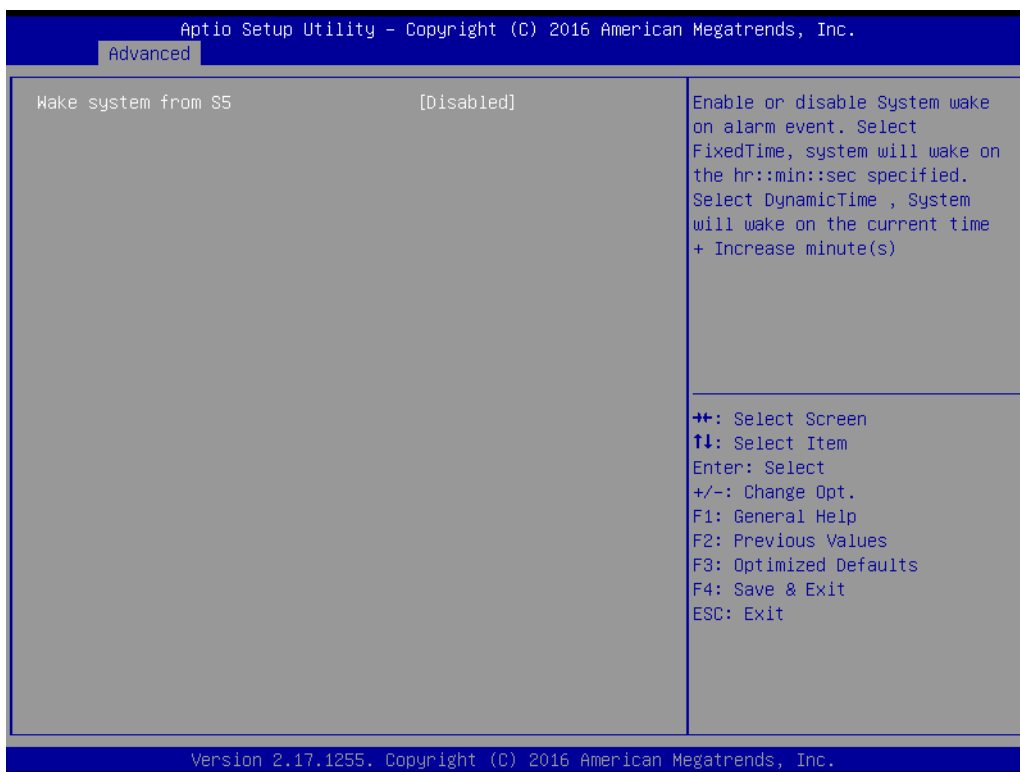

- **Wake system from S5 [Disabled]**
 Enable or disable system wake on alarm event.
 – Select FixedTime: System will wake on the specific hr:min:sec.

3.2.2.6 Serial Port Console Redirection

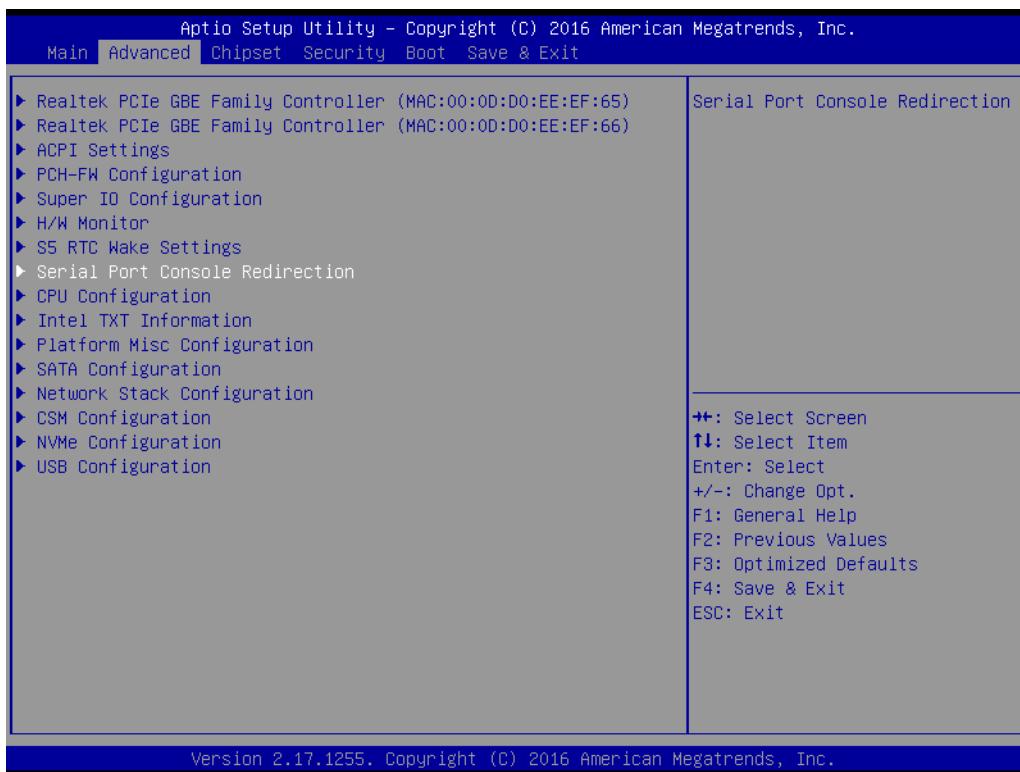

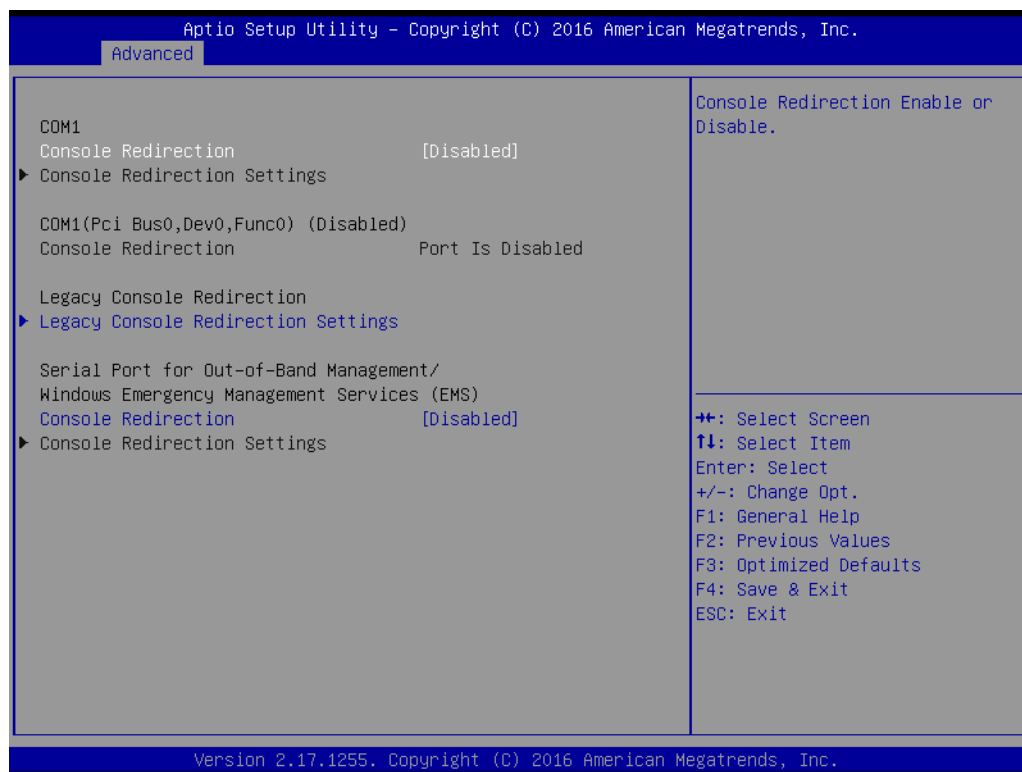

- **Console Redirection [Disabled]**
Enable or disable the console redirection feature

3.2.2.7 CPU Configuration

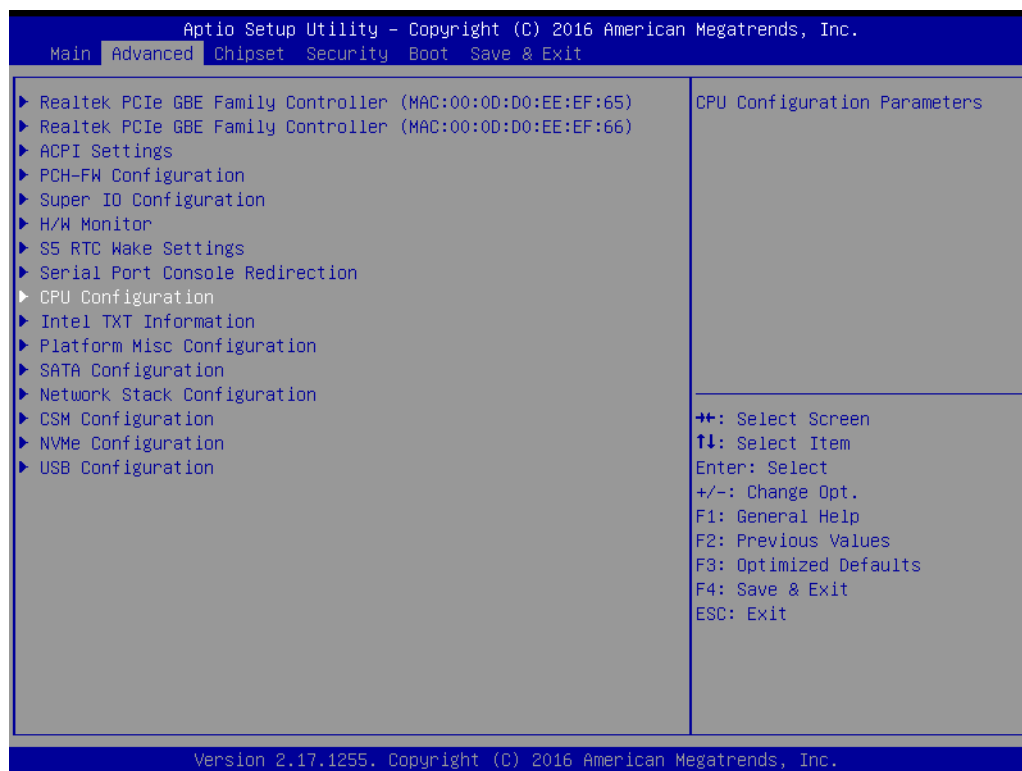

■ CPU Configuration

The item shows your CPU specification and features (content may be different with different CPUs).

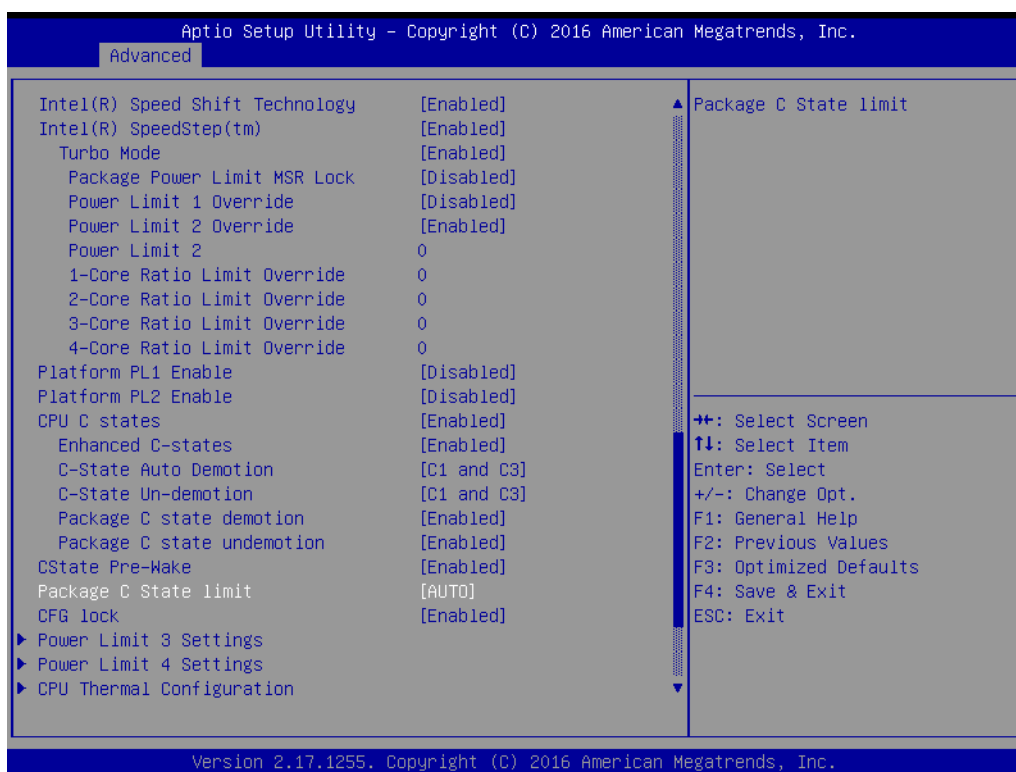
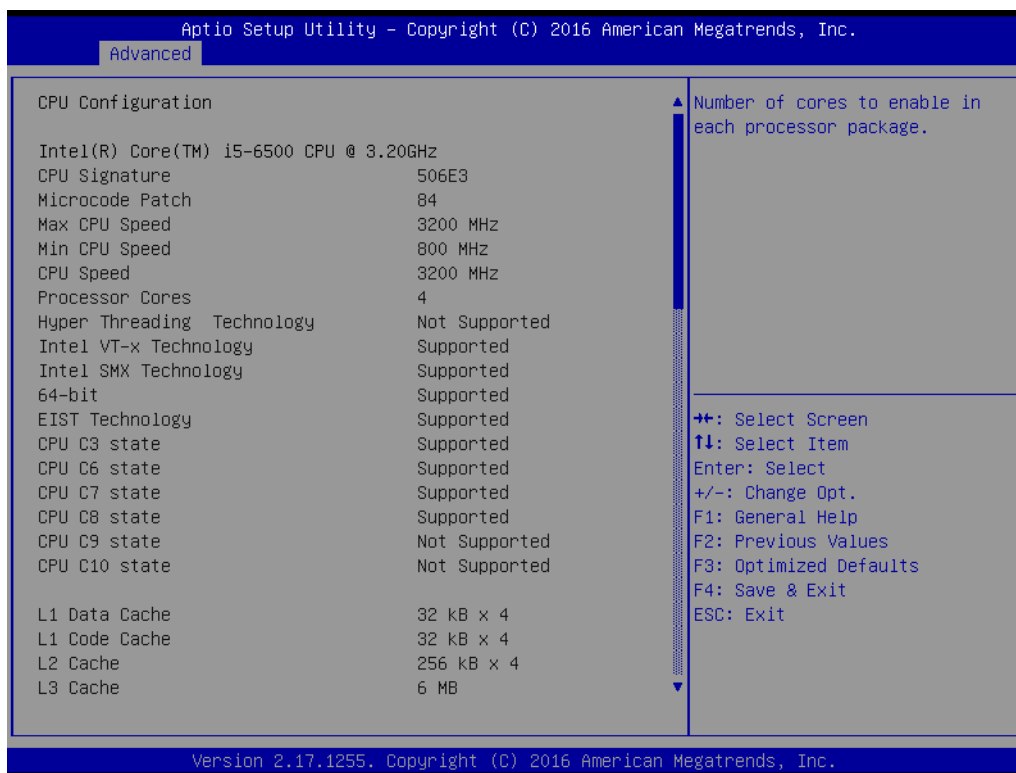

■ Power Limit 3 Settings



– Power Limit 3 Override [Disabled]

If this option is enabled, BIOS will leave the default values for Power Limit 3 and Power Limit 3 Power Window.

■ Power Limit 4 Settings

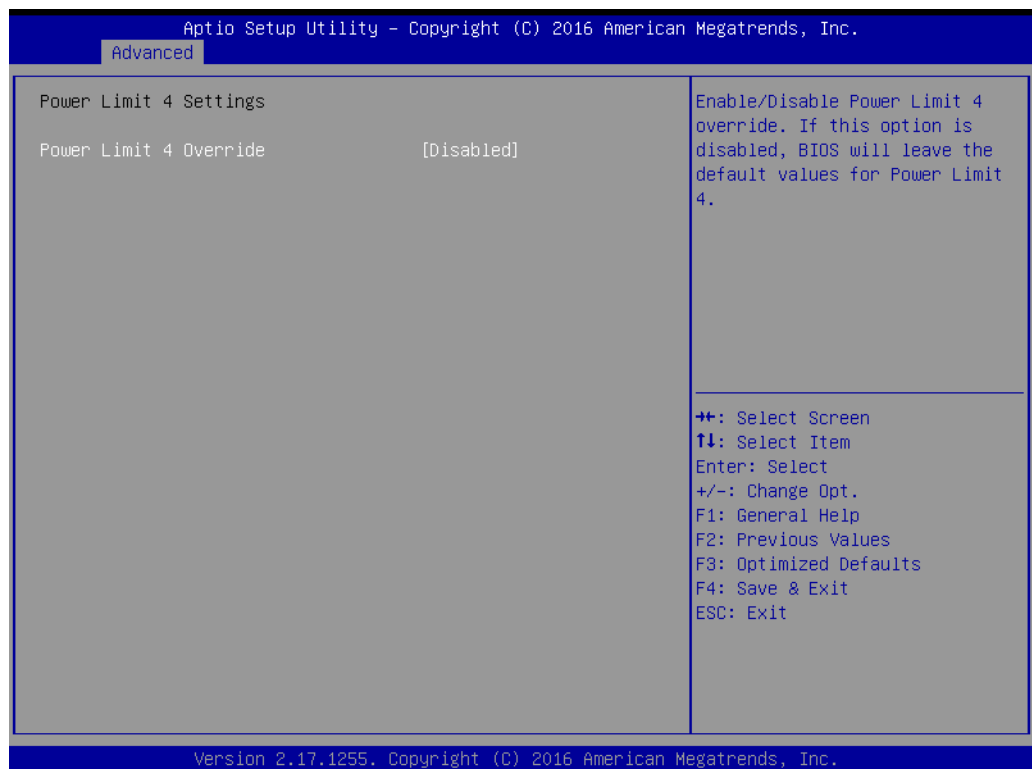

- Power Limit 4 Override [Disabled]
If this option is enabled, BIOS will leave the default values for Power Limit 4.

■ CPU Thermal Configuration

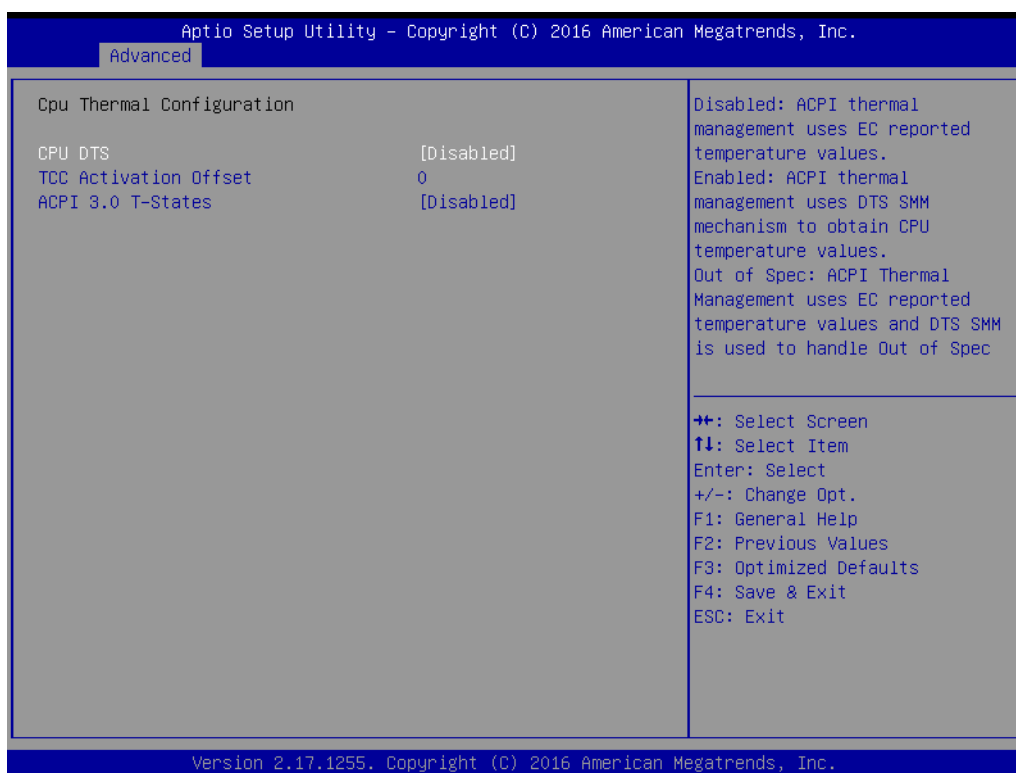

- CPU DTOS [Disabled]
Disable: ACPI thermal management uses EC reported temperature values.
Enable: ACPI thermal management use DTS SMM mechanism to obtain CPU temperature values.
Out of Spec: ACPI thermal management use EC reported temperature values and DTS SMM mechanism is used to handle Out of Spec.
- ACPI 3.0 T-States [Disabled]

3.2.2.8 Intel TXT Information

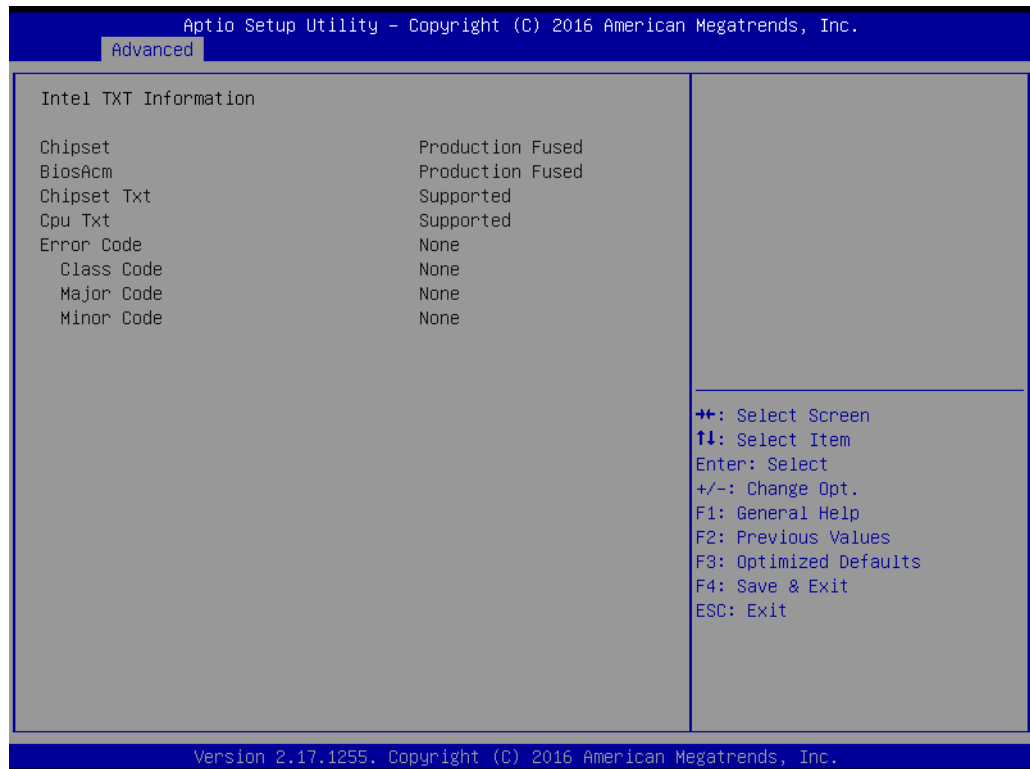
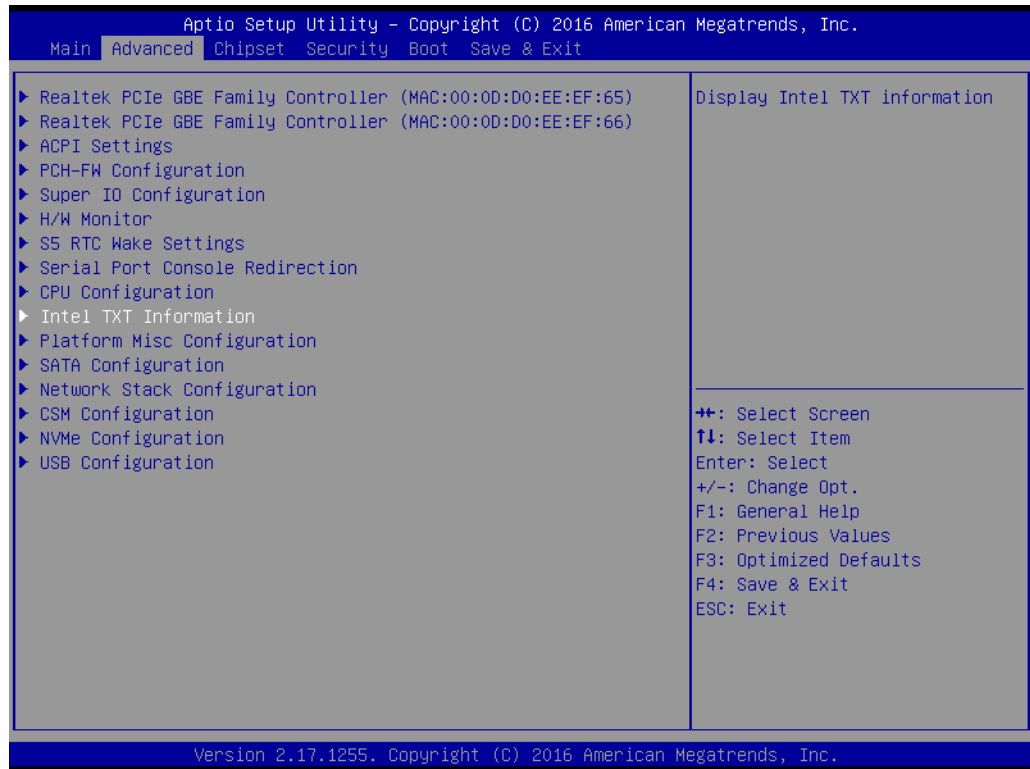

3.2.2.9 Platform Misc Configuration

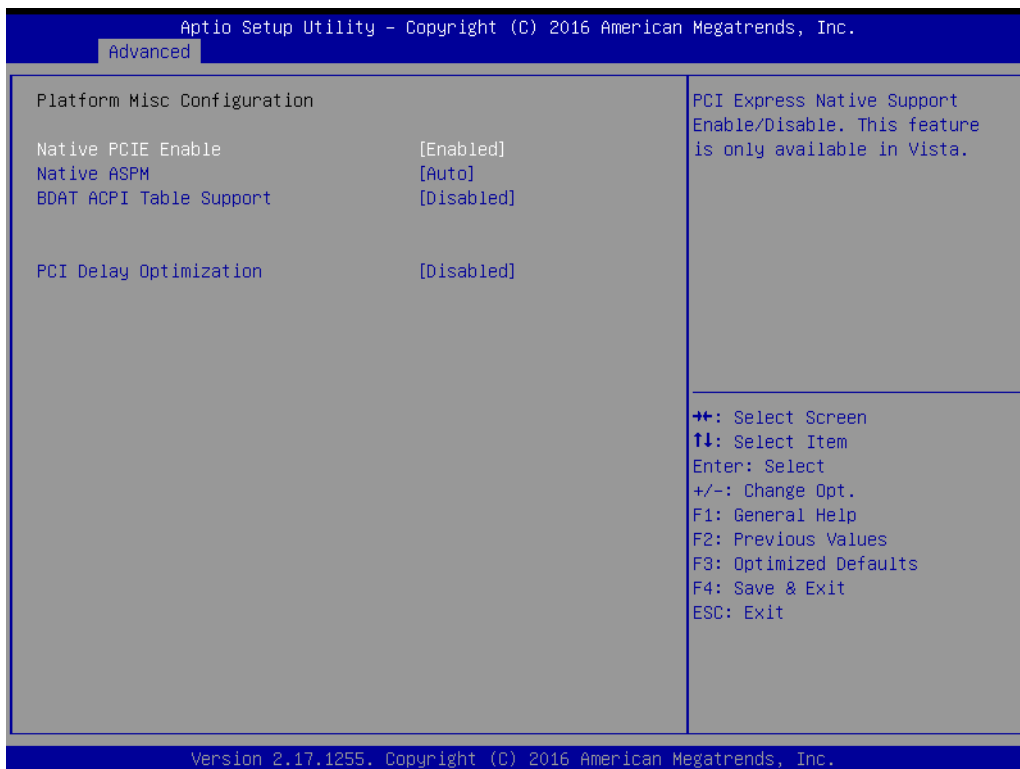
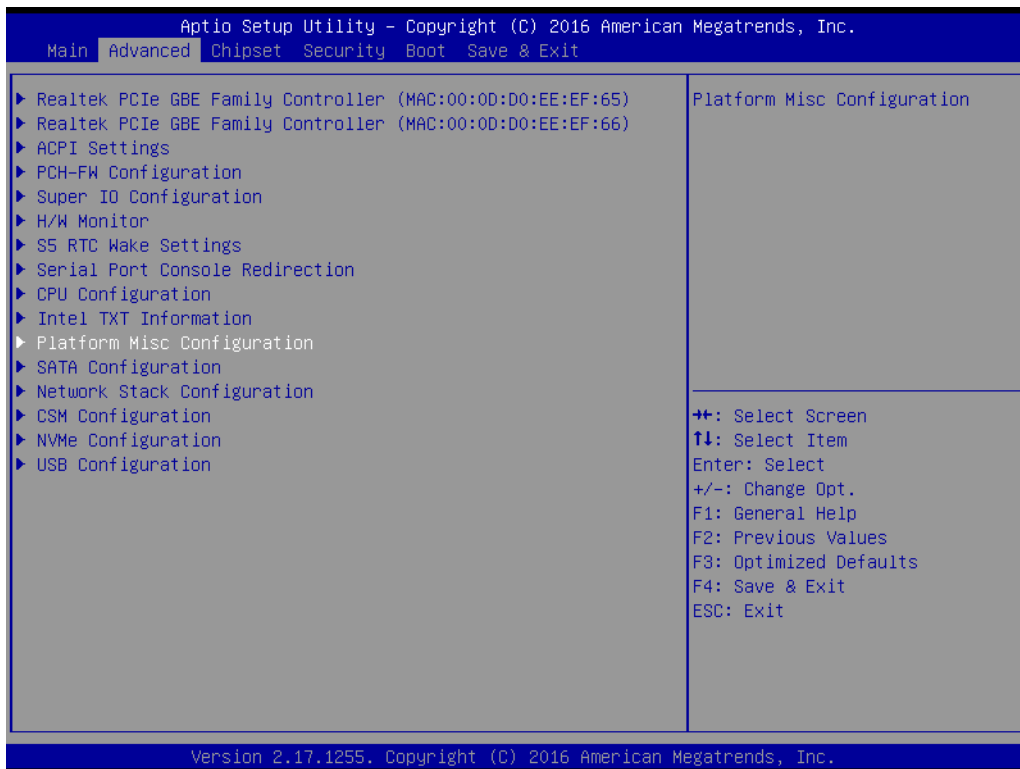

- **Native PCIE Enable [Enabled]**
 Note! PCI Express Native support is only available in Vista.
- **Native ASPM [Auto]**
- **BOAT ACPI Table Support [Disabled]**
- **PCI Delay Optimization [Disabled]**

3.2.2.10 SATA Configuration

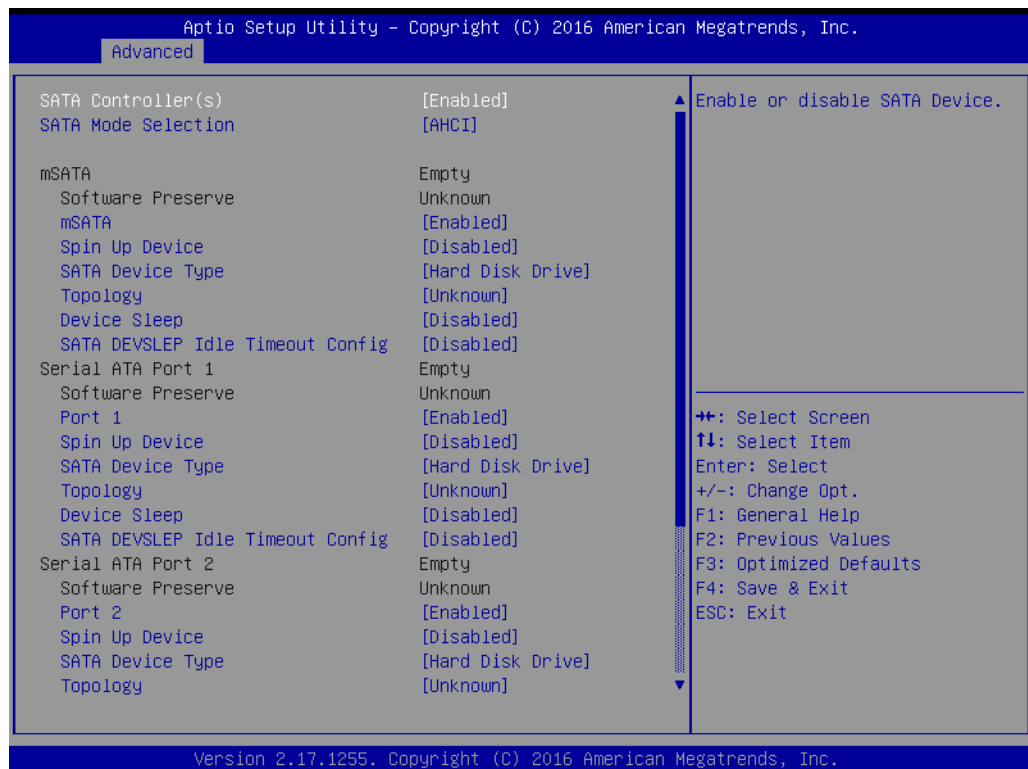
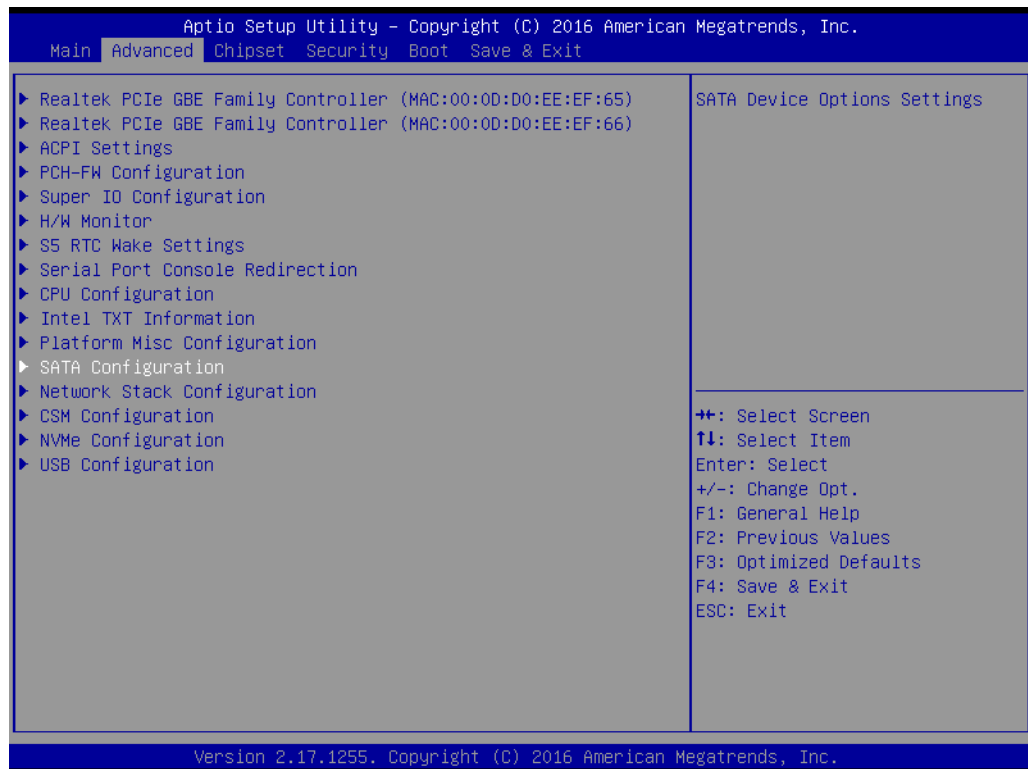

- **SATA Controllers [Enabled]**
- **SATA Mode Selection [AHCI]**
- **Aggressive LPM Support [Enabled]**
- **Serial ATA Port 1 [Enabled]**
- **Serial ATA Port 2 [Enabled]**

- Serial ATA Port 3 [Enabled]
- mSATA [Enabled]

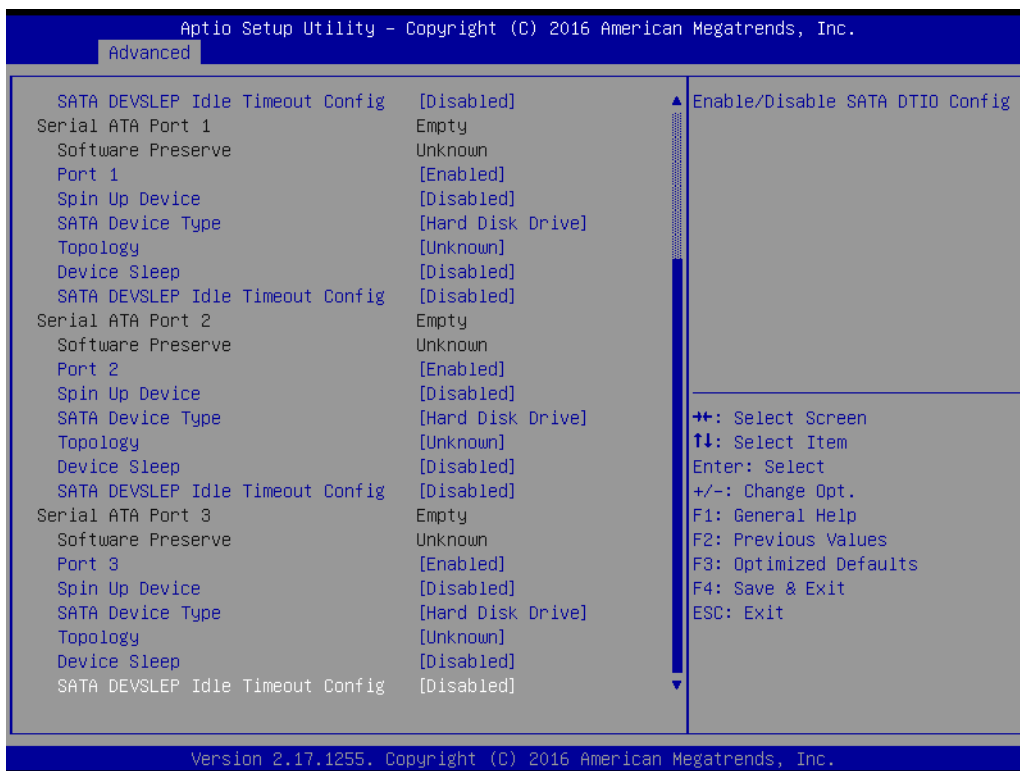

3.2.2.11 Network Stack Configuration

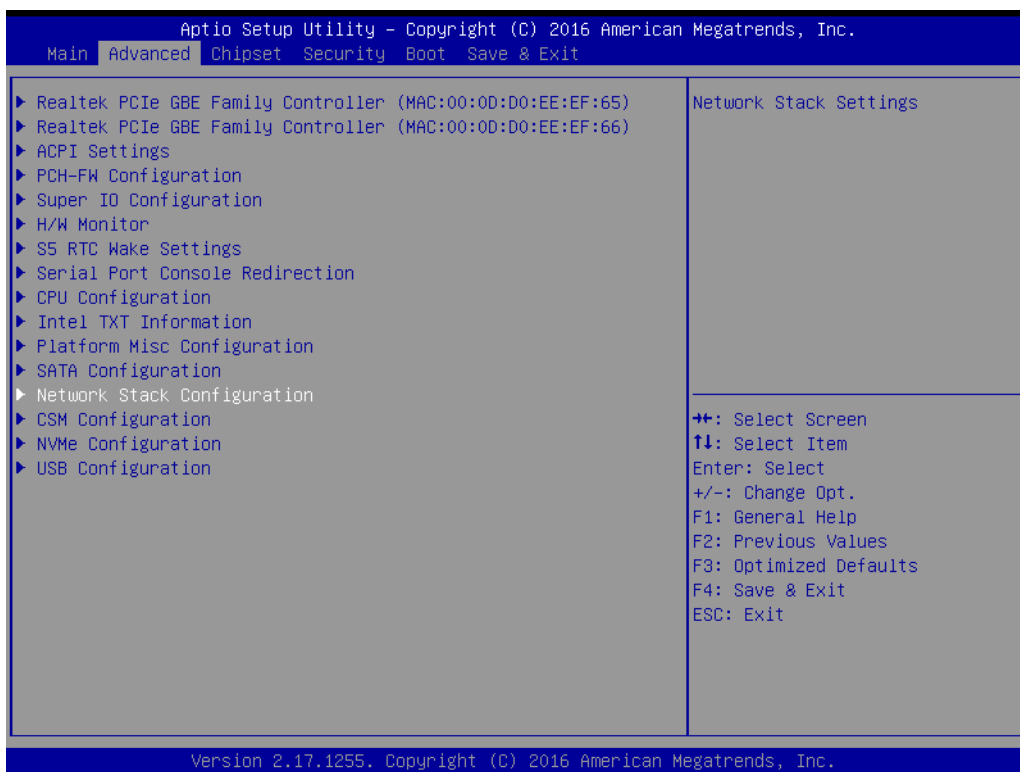



- **Network Stack [Disabled]**
Enable / Disable UEFI Network Stack

3.2.2.12 CSM Configuration

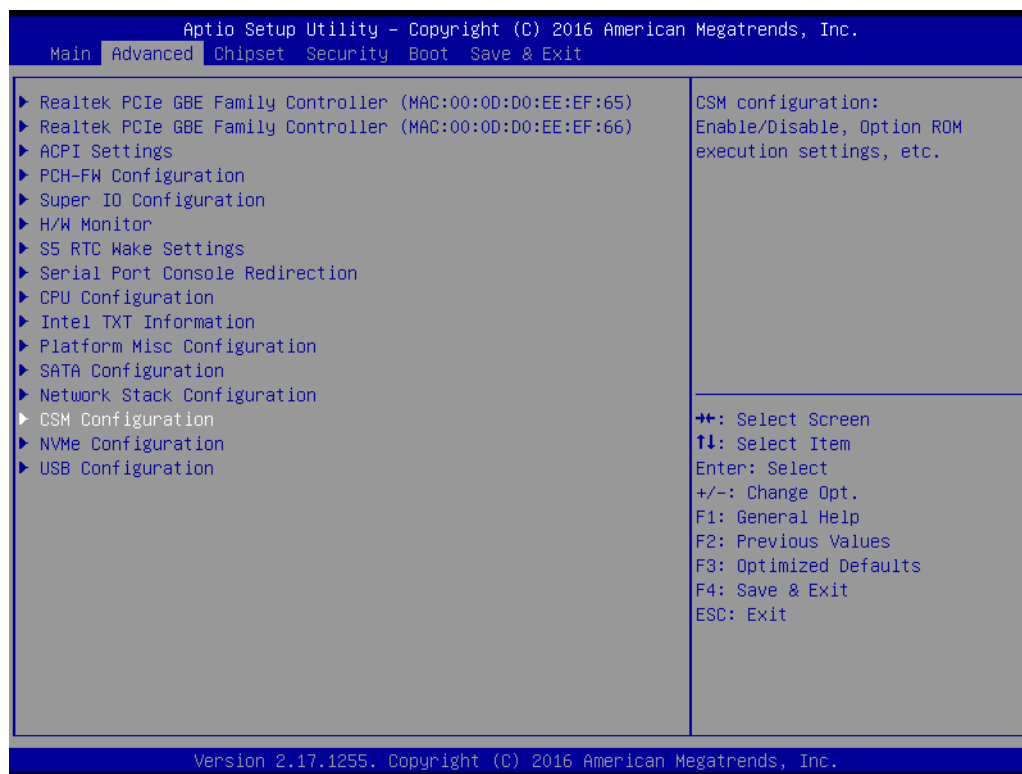

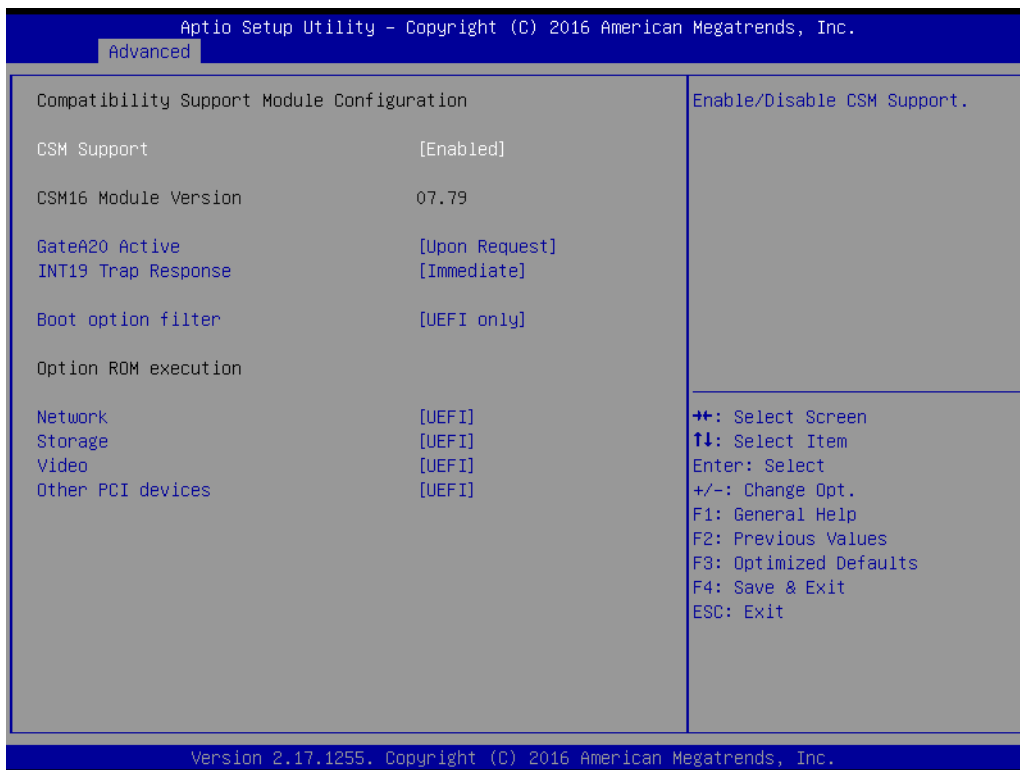

- **CSM Support [Enabled]**
- **Boot option filter [UEFI only]**
- **Option ROM execution**
 - Network [UEFI]
 - Storage [UEFI]
 - Video [UEFI]
 - Other PCI device [UEFI]

Note! *If your HDD or other boot device is installed as Legacy mode, it may cause a blue screen. There are 2 ways to resolve this:*



1. *Re-install your OS in UEFI Mode*
2. *Change all of the settings above as "Legacy"*
 - *- Boot option filter -> Legacy Only*
 - *- Network -> Legacy*
 - *- Storage -> Legacy*
 - *- Video -> Legacy*
 - *- Other PCI devices -> Legacy*

3.2.2.13 NVMe Configuration

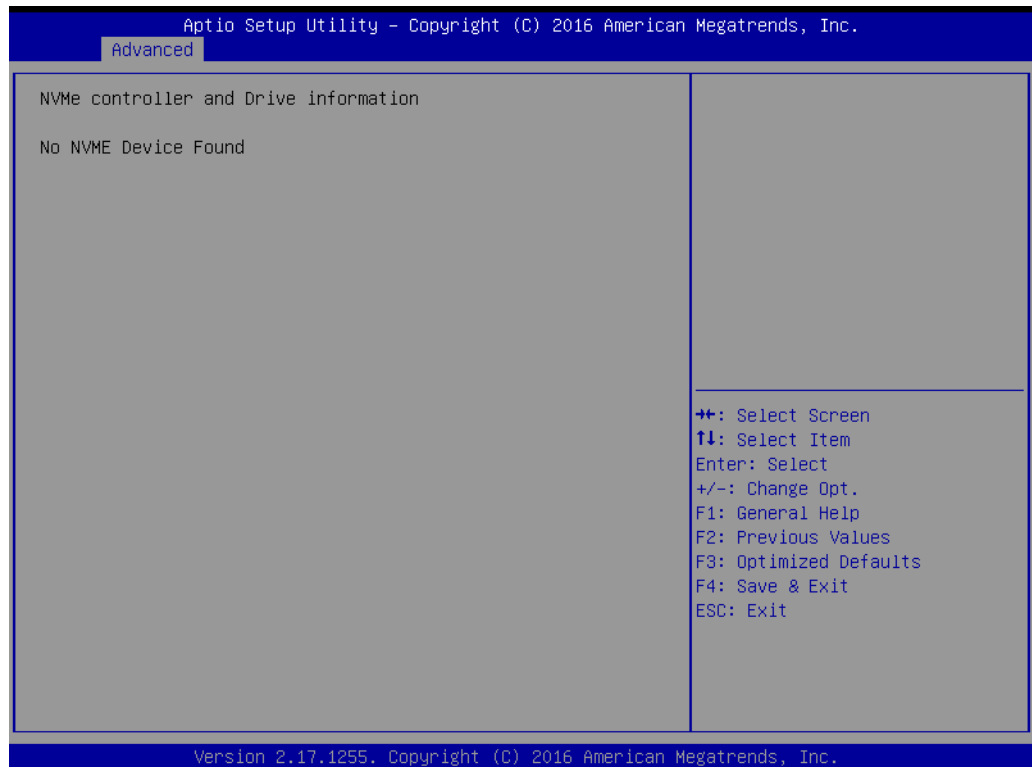
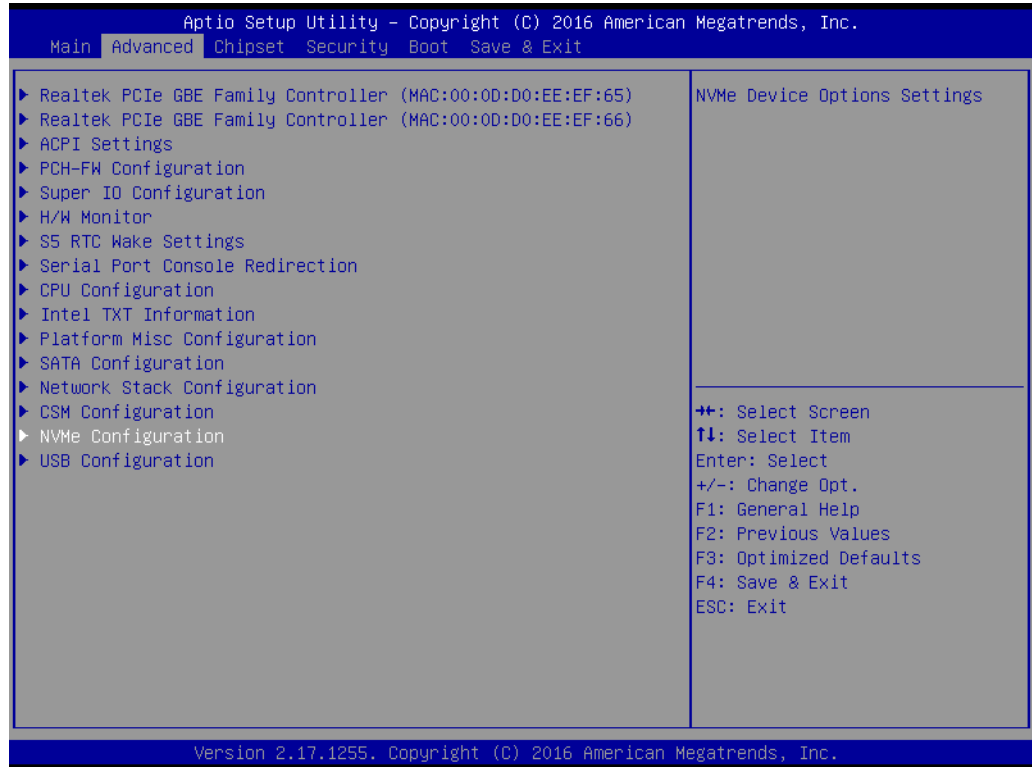

3.2.2.14 USB Configuration

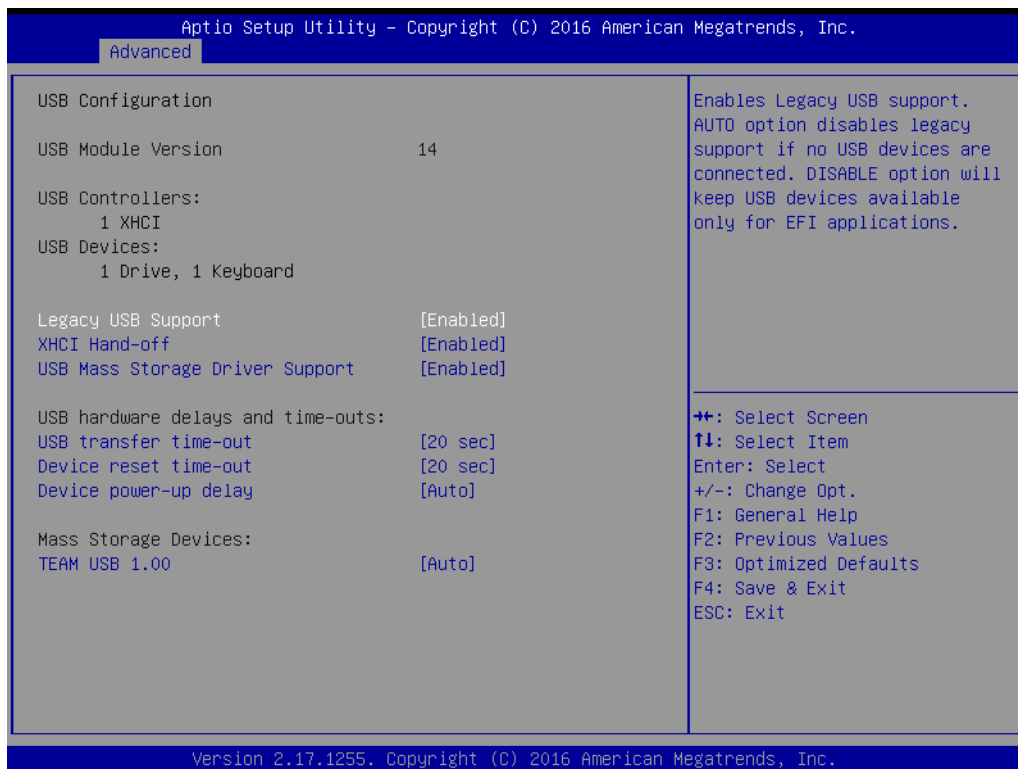
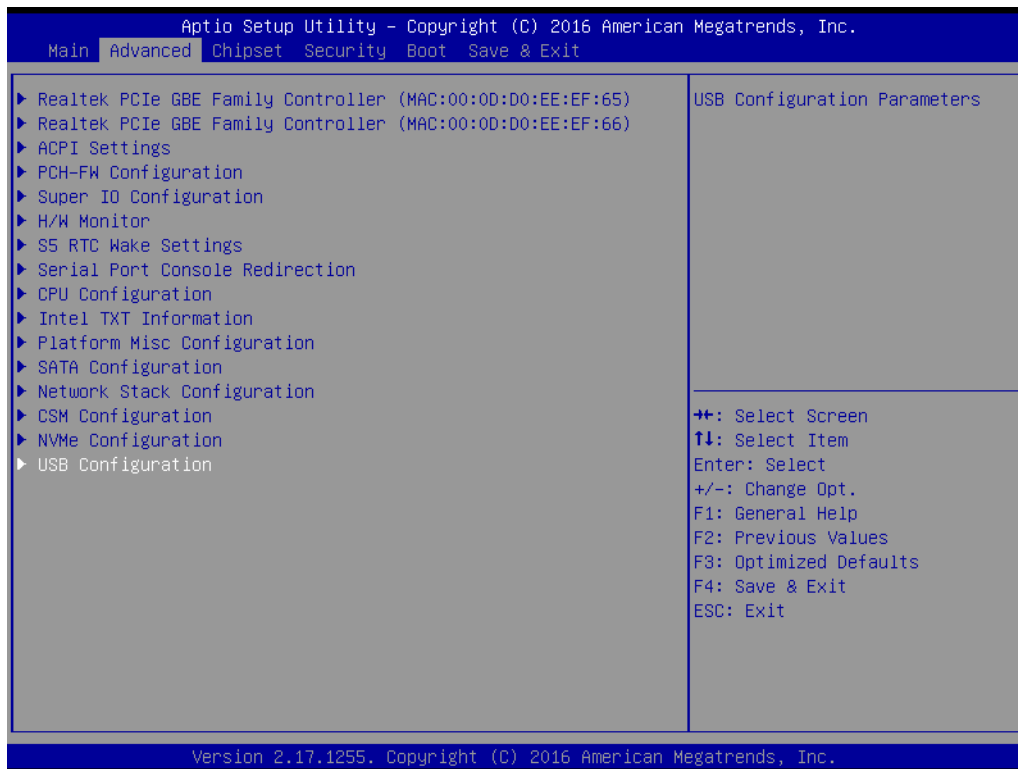

- **Legacy USB Support [Enabled]**
Enables support for legacy USB. Auto option disables legacy support if no USB devices are connected.
- **XHCI Hand-off [Enabled]**
- **USB Mass Storage Driver Support [Enabled]**
- **USB hardware delays and time-outs**
USB Device transfer & reset time-out and delay setting.
- **Mass Storage Devices [Auto]**
Auto detect the USB device you connected and shows USB mass storage device information.

3.2.3 Chipset Configuration Setting

Select the chipset tab from the BIOS setup screen to enter the Chipset Setup screen. Users can select any item in the left frame of the screen, such as PCI express Configuration, to go to the sub menu for that item. Users can display a Chipset Setup option by highlighting it using the <Arrow> keys. All Chipset Setup options are described in this section. The Chipset Setup screens are shown below. The sub menus are described on the following pages.



3.2.3.1 System Agent (SA) Configuration

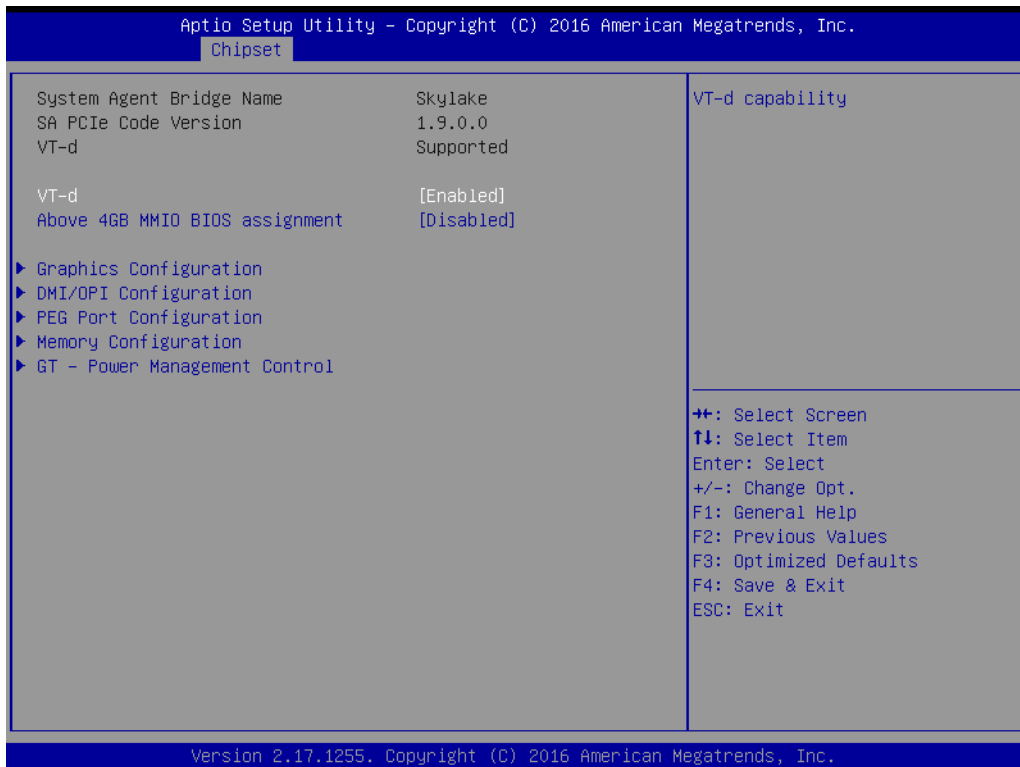

- **VT-d [Enabled]**
Disable or enable VT-d capability.
- **Above 4GB MMIO BIOS assignment [Disabled]**
- **Graphics Configuration**

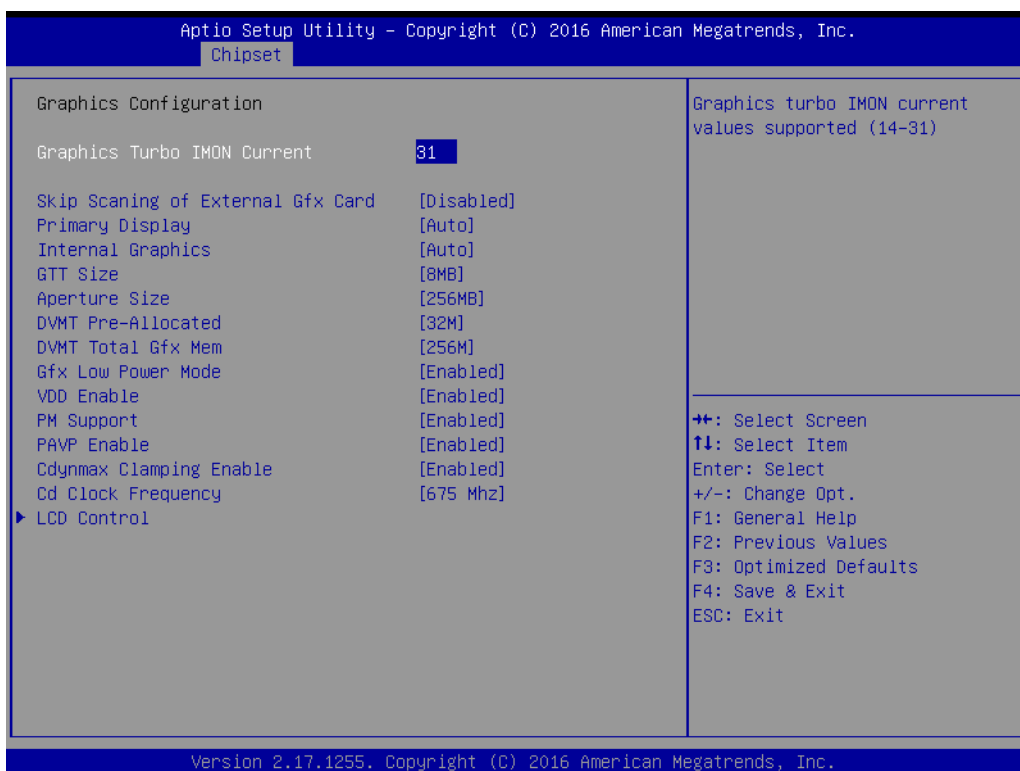

- Graphics Turbo IMON Current [31]
Graphics turbo IMON Current values supported (14-31).
- Primary Display [Auto]
Select which of IGFX/PEG/PCI Graphics device should be Primary Display
- Internal Graphics [Auto]
Keep IGD enabled based on the setup options.
- GTT Size [8MB]
- Aperture Size [256MB]
- DVMT Pre-Allocated [32M]
Select DVMT 5.0 Pre-Allocated (Fixed) Graphics Memory size used by the Internal Graphics Device.
- DVMT Total Gfx Mem [256M]
Select DVMT5.0 Total Graphic Memory size used by the Internal Graphics Device.
- Gfx Low Power Mode [Enabled]
Note! This option is applicable for SFF only
- VDD Enable [Enabled]
- PM Support [Enabled]
- PAVP Enable [Enabled]
- Cdynmax Clamping Enable [Enabled]
- Cd Clock Frequency [675 Mhz]

■ **LCD Control**

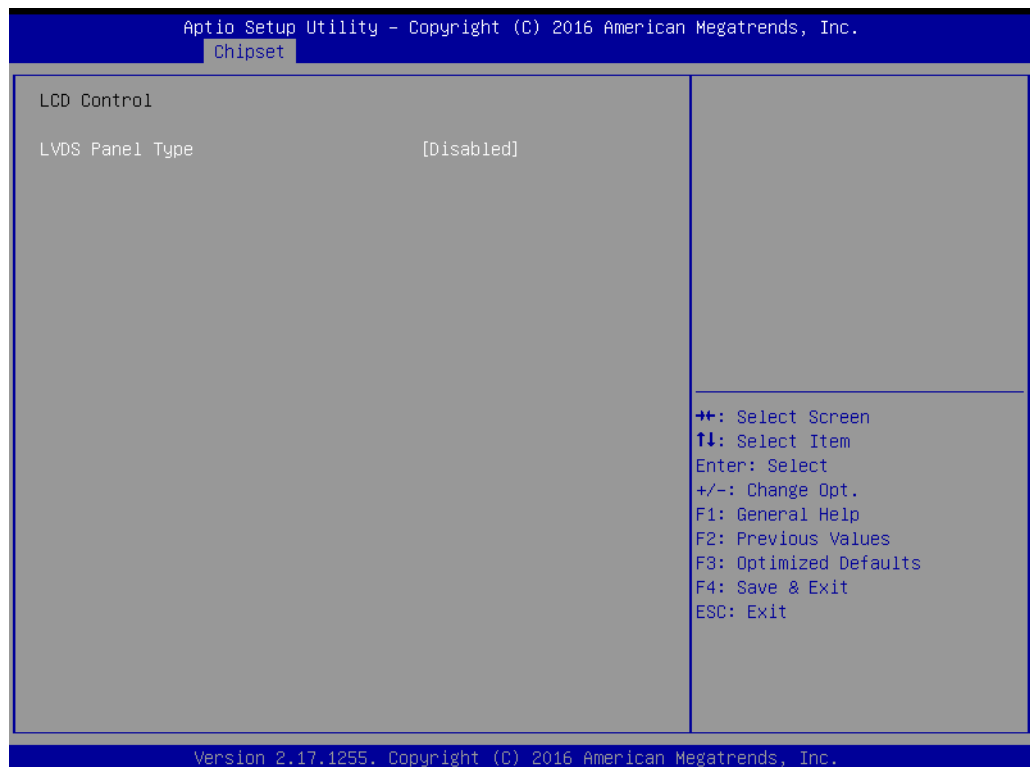

- LVDS Panel Type [Disabled]

■ DMI/ OPI Configuration

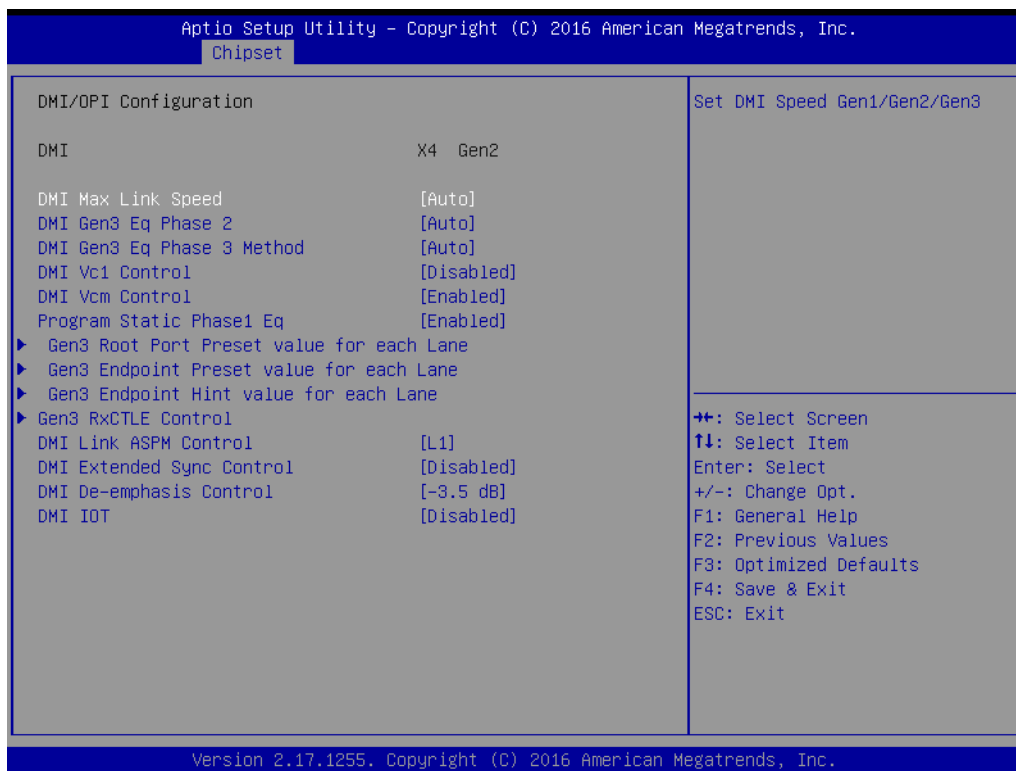

- DMI Max Link Speed [Auto]
Set DMI Speed at Gen1/ Gen2/ Gen3.

■ Gen3 Root Port Press Value for each Lane

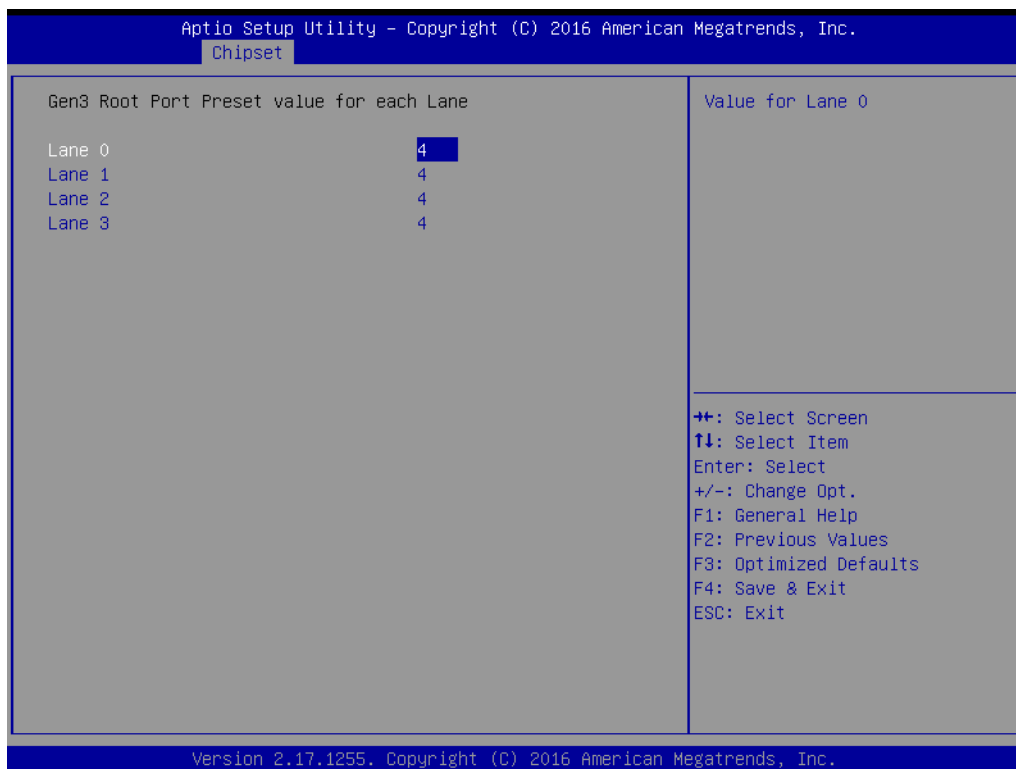

■ **Gen3 Endpoint Preset value for each Lane**

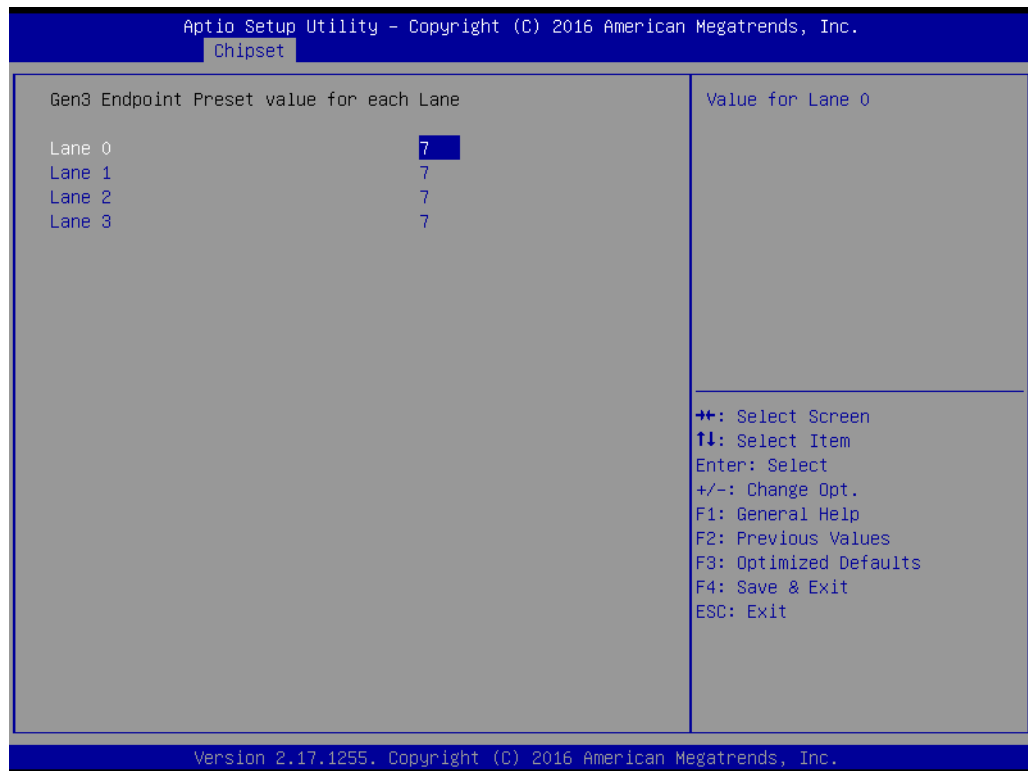

■ **Gen3 Endpoint Hint value for each Lane**

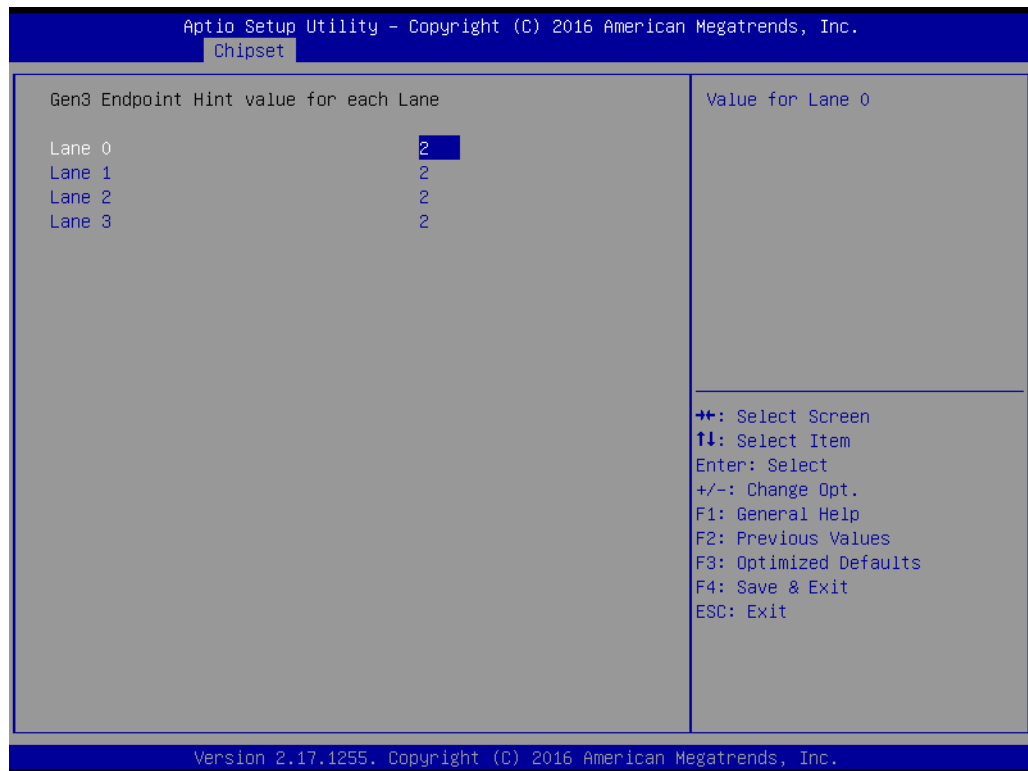

■ Gen 3 RxCLTE Control

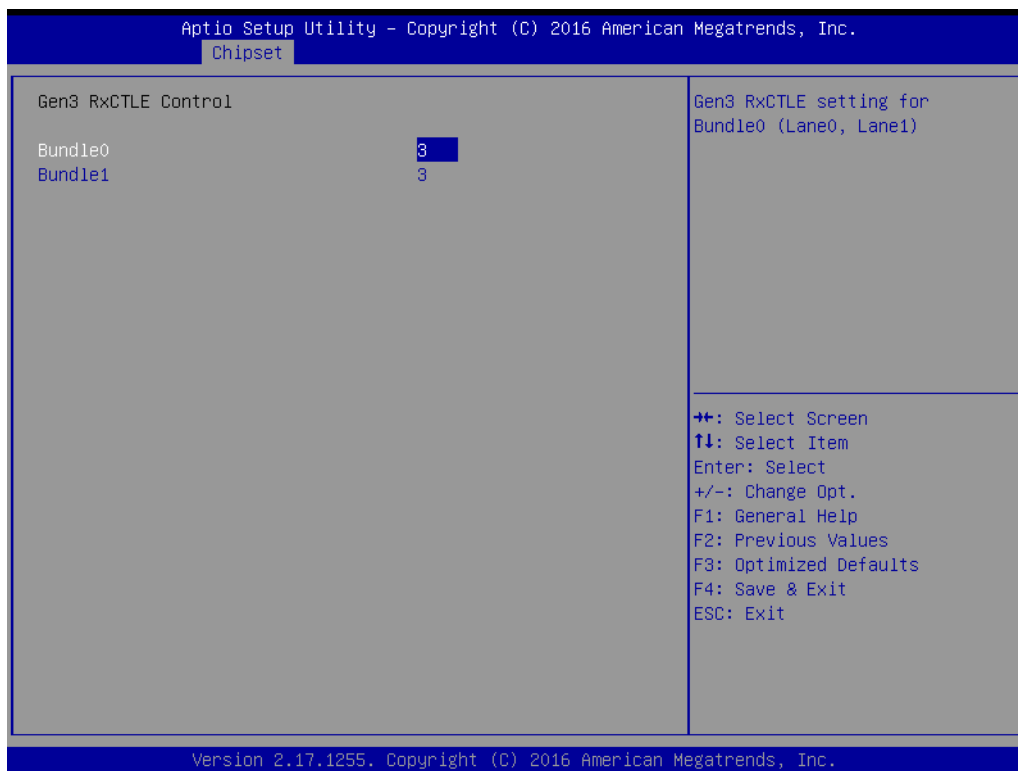

■ PEG Port Configuration

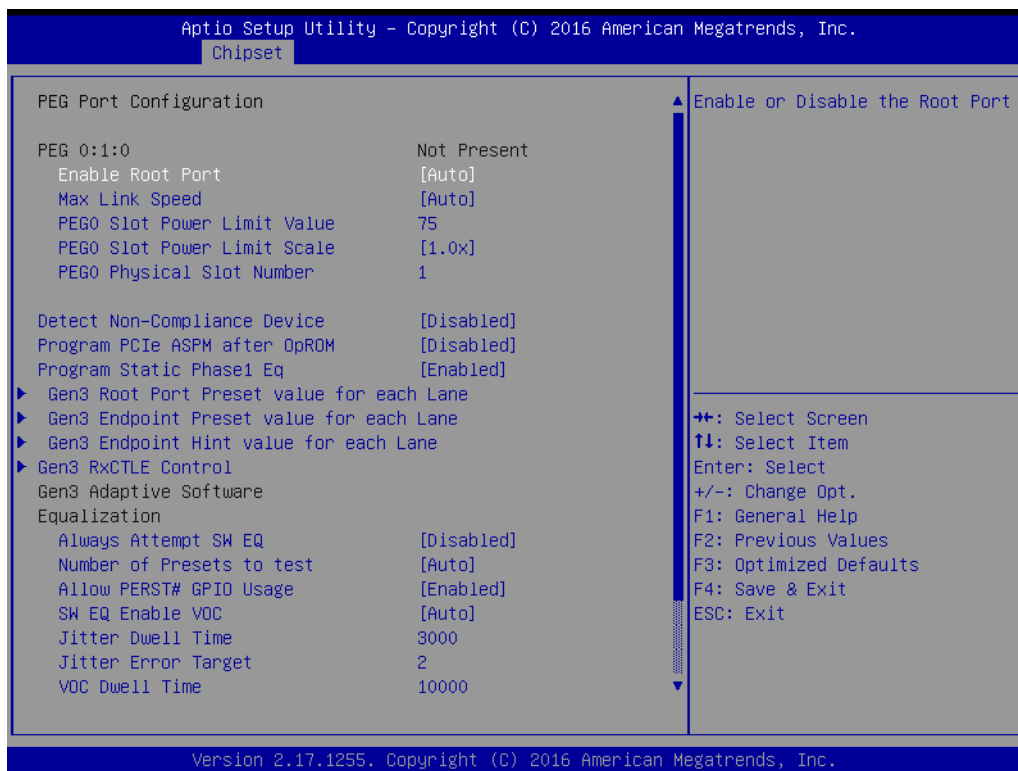

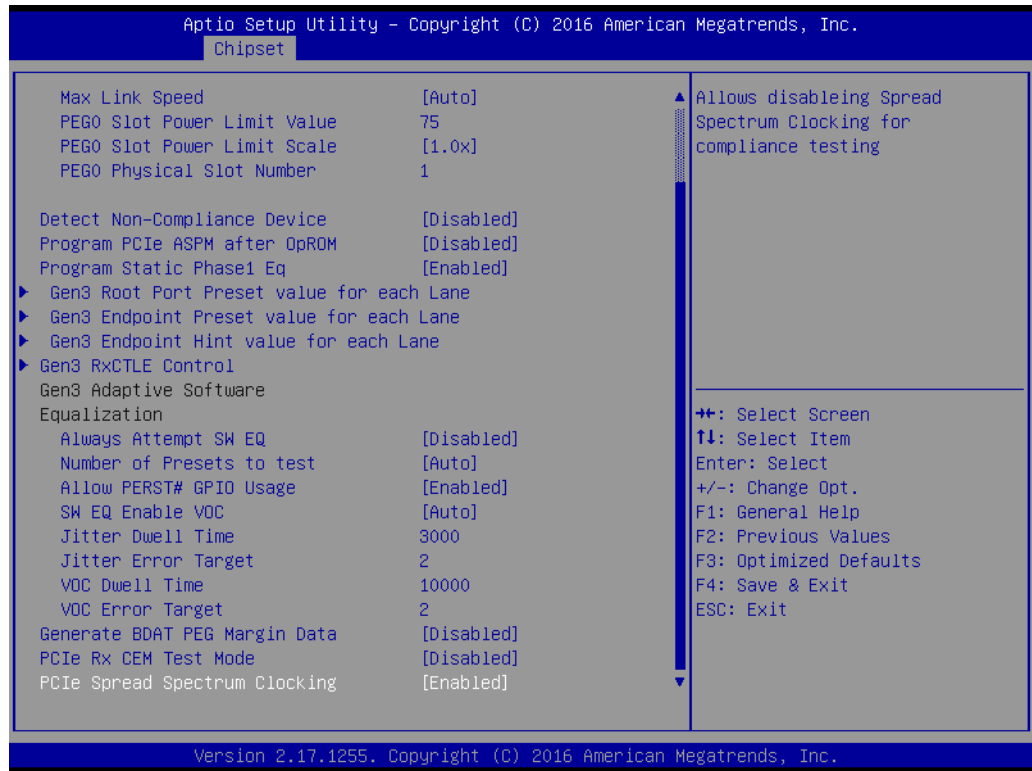

- Enable Root Port [Auto]
- Max Link Speed [Auto]
- Detect Non-Compliance Device [Disabled]
Detect Non-Compliance PCI Express Device in PEG
- Program PCIe ASPM after OpROM [Disabled]
Enabled: PCIe ASPM will be programmed after OpROM.
Disabled: PCIe ASPM will be programmed before OpROM.
- Program Static Phase1 Eq [Enabled]
- PEG Sampler Calibrate [Disabled]

■ Gen3 Root Port Preset value for each Lane

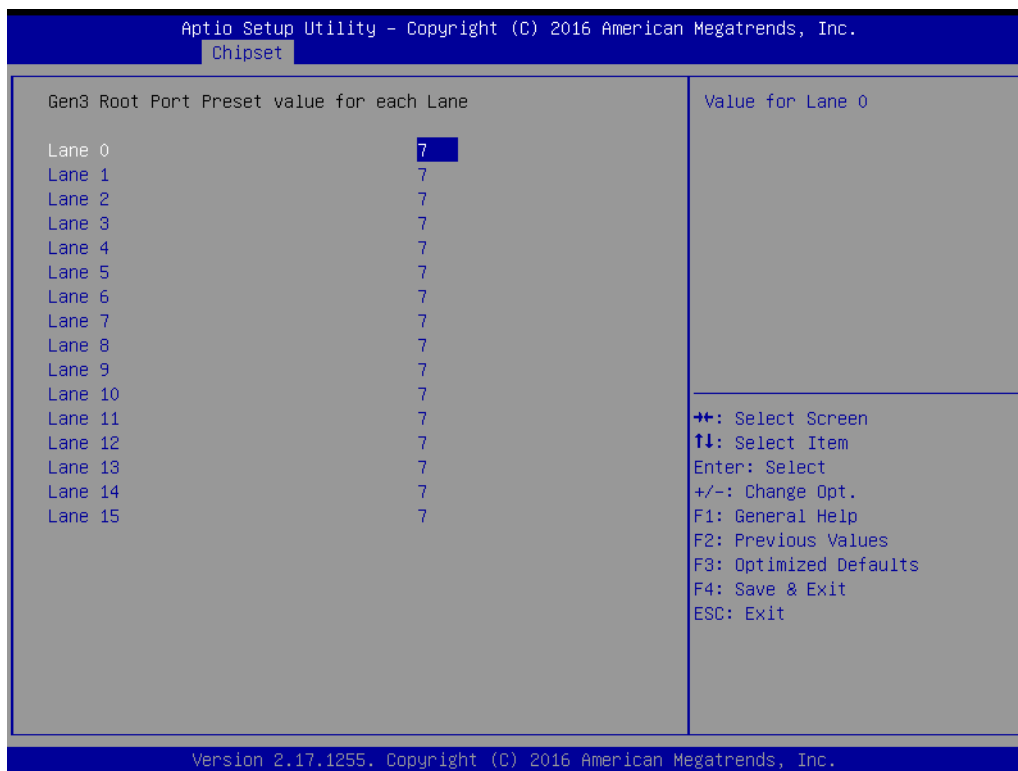

■ Gen3 Endpoint Preset value for each Lane

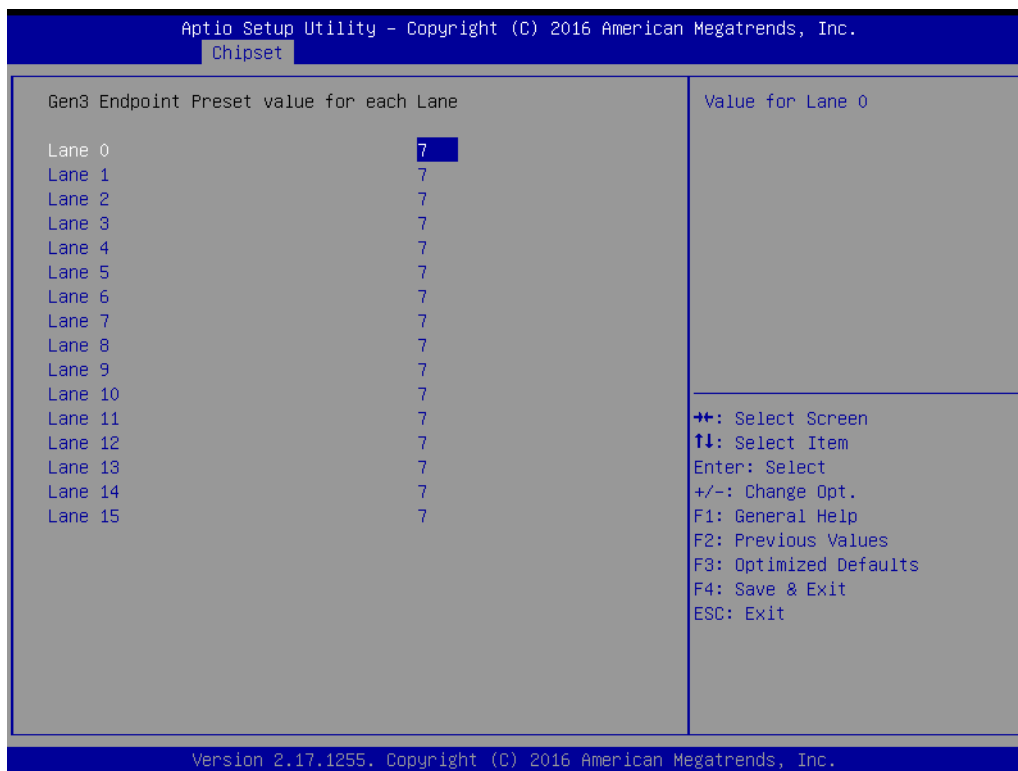

■ **Gen3 Endpoint Hint value for each Lane**

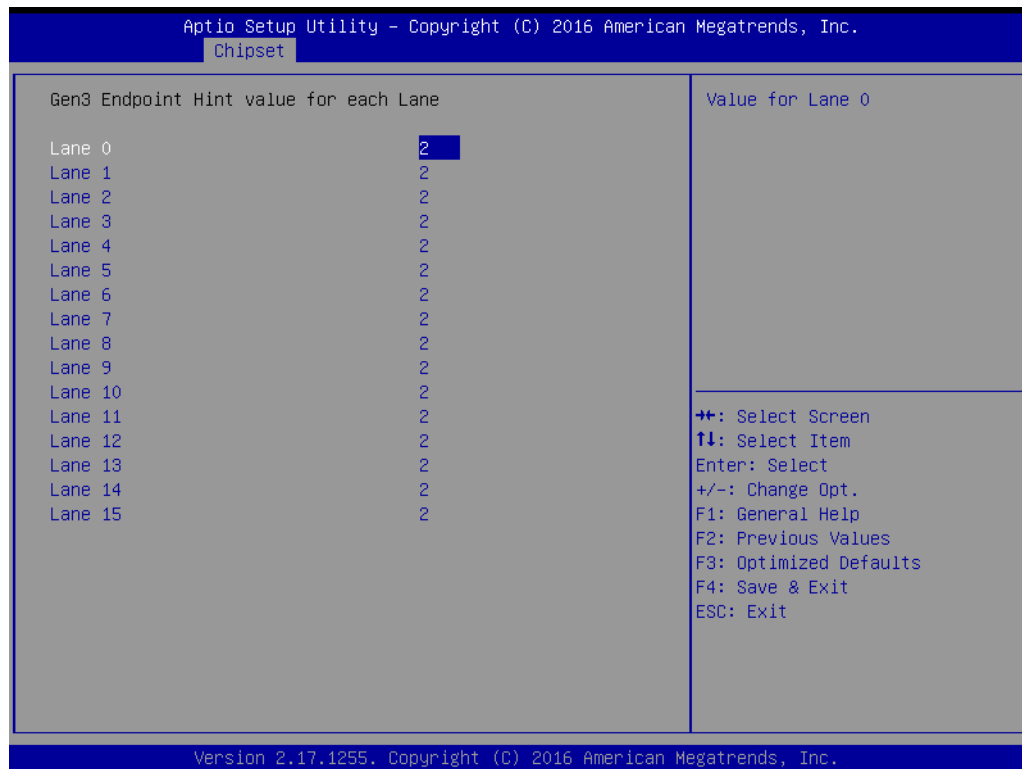

■ **Gen3 RxCTLE Control**

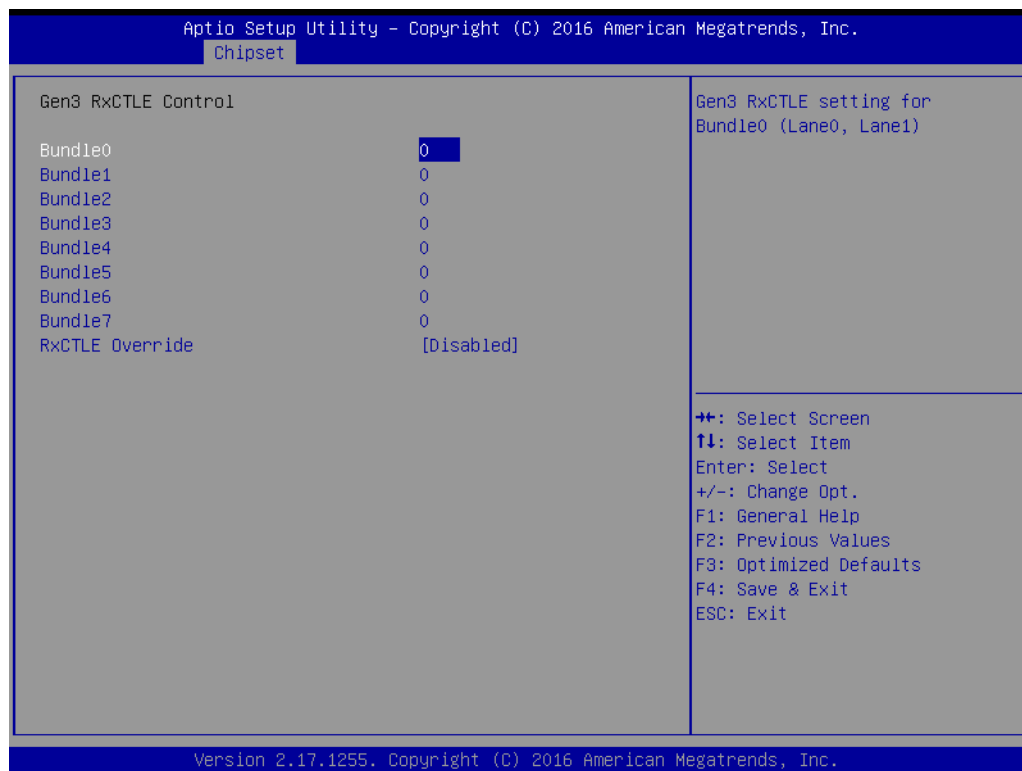

– RxCTLE Override [Disabled]

■ Memory Configuration

The item shows you memory specification included RC version, Frequency, size and voltage information etc.

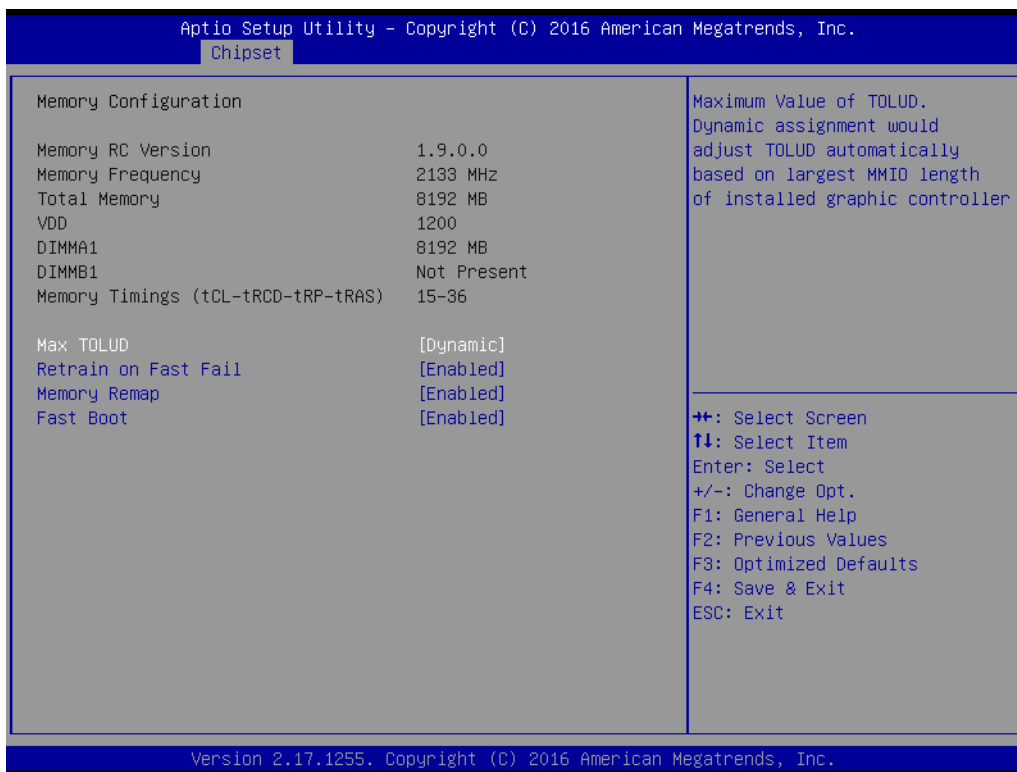

- Max TOLUD [Dynamic]
Maximum Value of TOLUD.
Dynamic assignment would adjust TOLUD automatically based on largest MMIO length of installed graphic controller.
- Retrain on Fast Fail [Enabled]
- Memory Remap [Enabled]
- Fast Boot [Enabled]

■ GT- Power Management Control

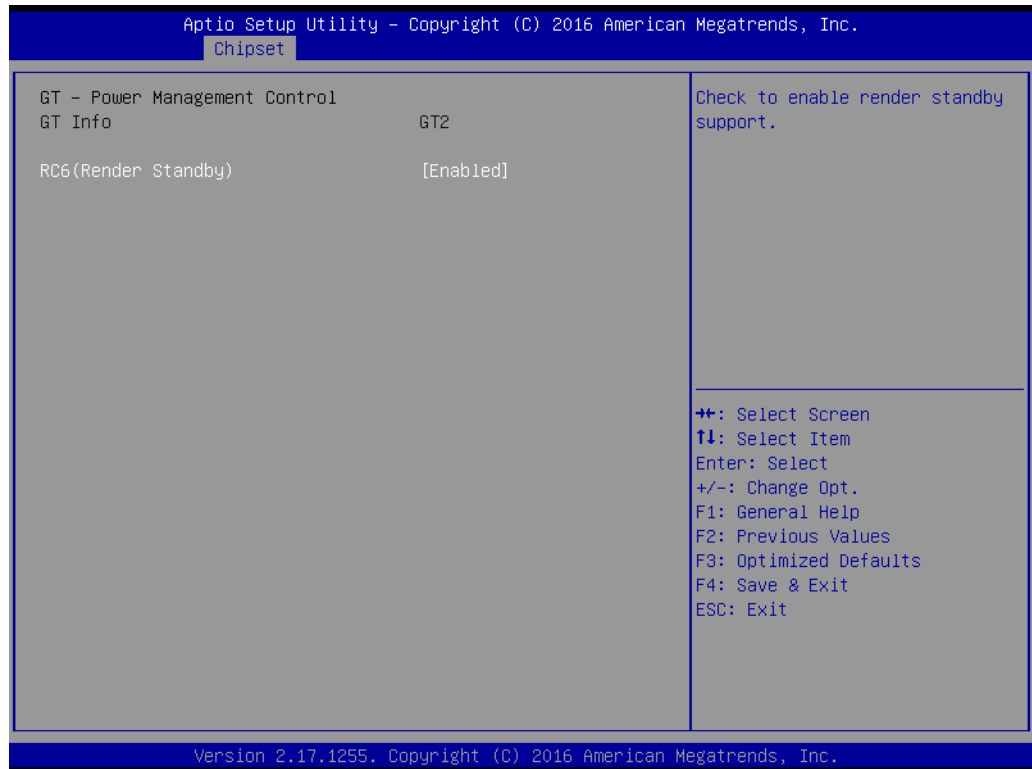

- RC6 (Render Standby) [Enabled]
Check to enable / disable render standby supported.

3.2.3.2 PCH-IO Configuration





- **LAN1 Control [Enabled]**
Enable or disable the LAN 1 controller.
- **LAN 2 controller [Enabled]**
Enable or disable the LAN 2 controller.
- **PCIE Wake [Disabled]**
Enable or disable PCIE Wake feature.
- **Deep Sleep [Disabled]**
Enable or disable the Deep Sleep function.
- **High Precision Timer [Enabled]**
- **Start After G3 [Power Off]**

■ PCI Express Configuration

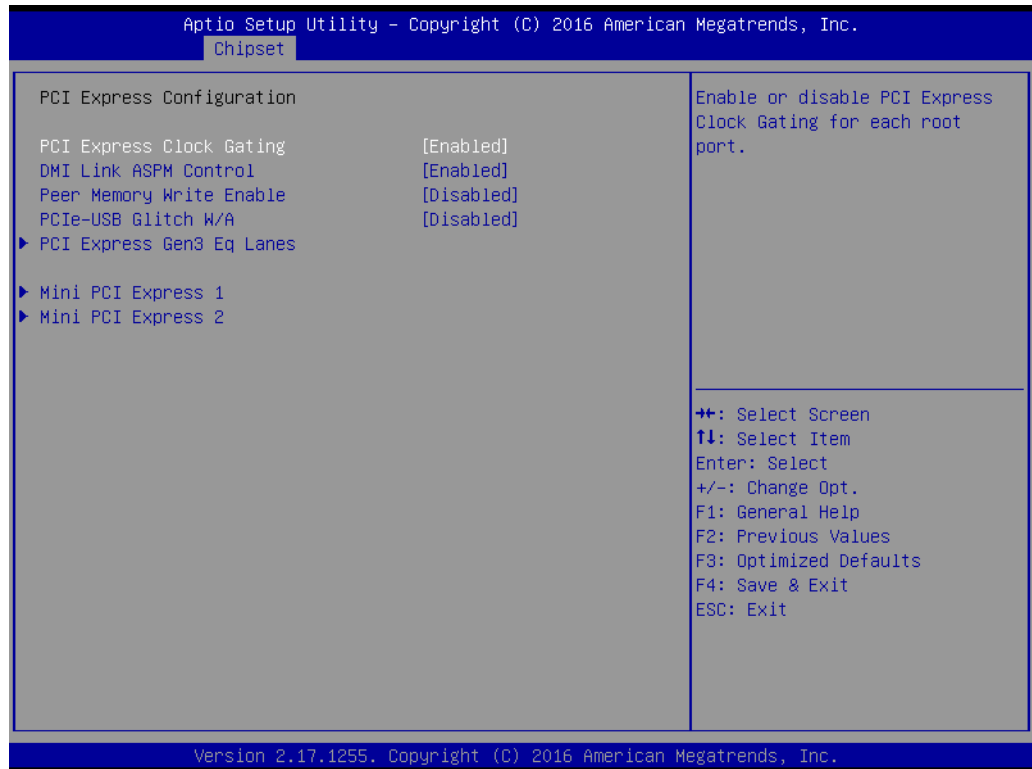

- PCI Express Clock Gating [Enabled]
Enable or disable PCI Express Clock Gating for each root port.
- DMI Link ASPM Control [Enabled]
Enable or disable the control of Active State Power Management on SA side of the DMI Link.
- Peer Memory Write Enable [Disabled]
- PCIe-USB Glitch W/A [Disabled]

■ PCI Express G3 Eq Lanes

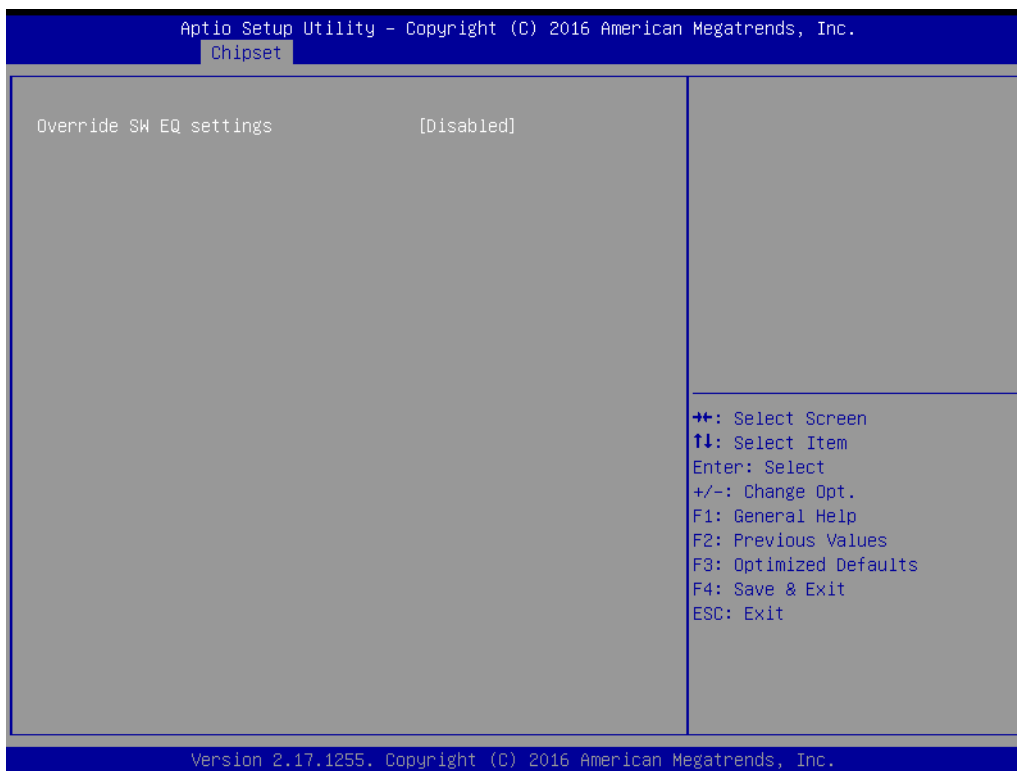

- Override SW EQ settings [Disabled]

■ Mini PCI Express1

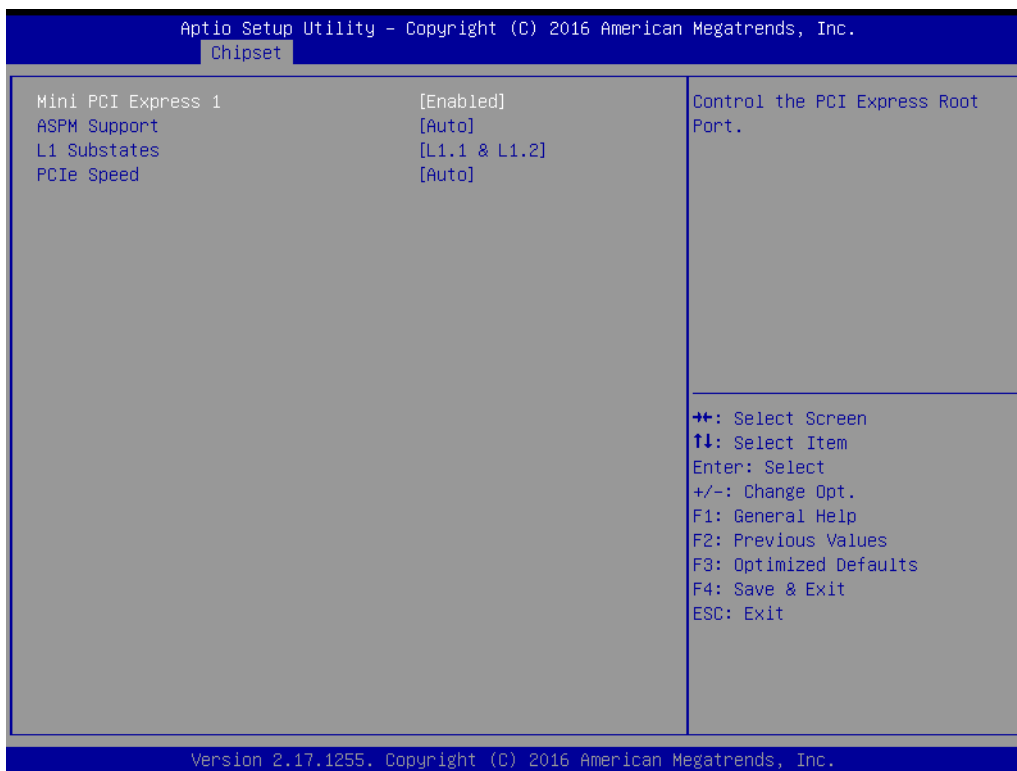

- Mini PCI Express [Enabled]
Enable or disable PCI Express Root Port controller.
- ASPM Support [Auto]

- L1 Substates [L1.1 & L1.2]
- PCIe Speed [Auto]

■ **Mini PCI Express2**

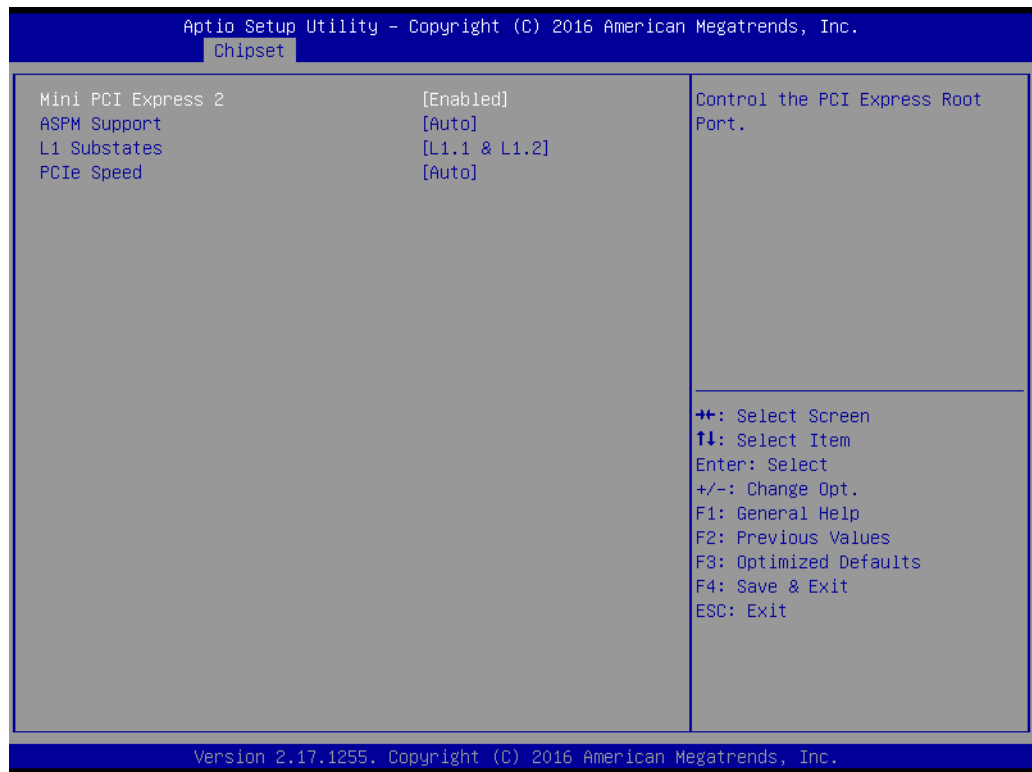

- Mini PCI Express [Enabled]
Enable or disable PCI Express Root Port controller.
- ASPM Support [Auto]
- L1 Substates [L1.1 & L1.2]
- PCIe Speed [Auto]

■ USB Configuration

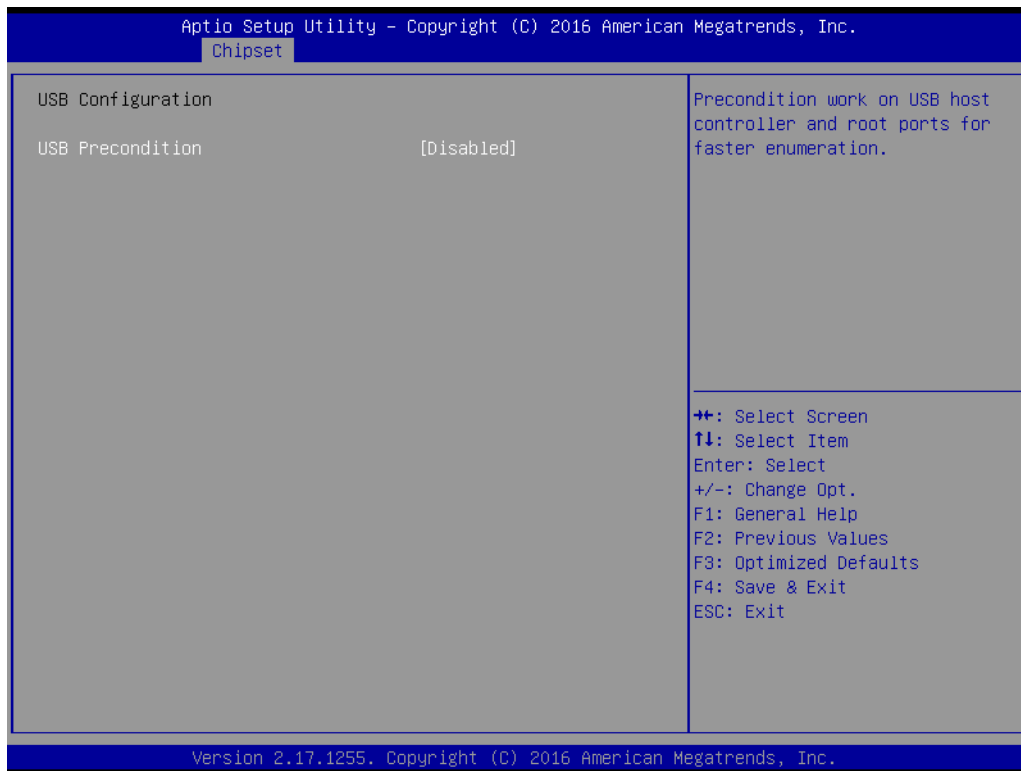

– USB Pre-condition [Disabled]

Note! *USB 2.0 & 3.0 only supported from 1 XHCI controller.*



■ BIOS Security Configuration

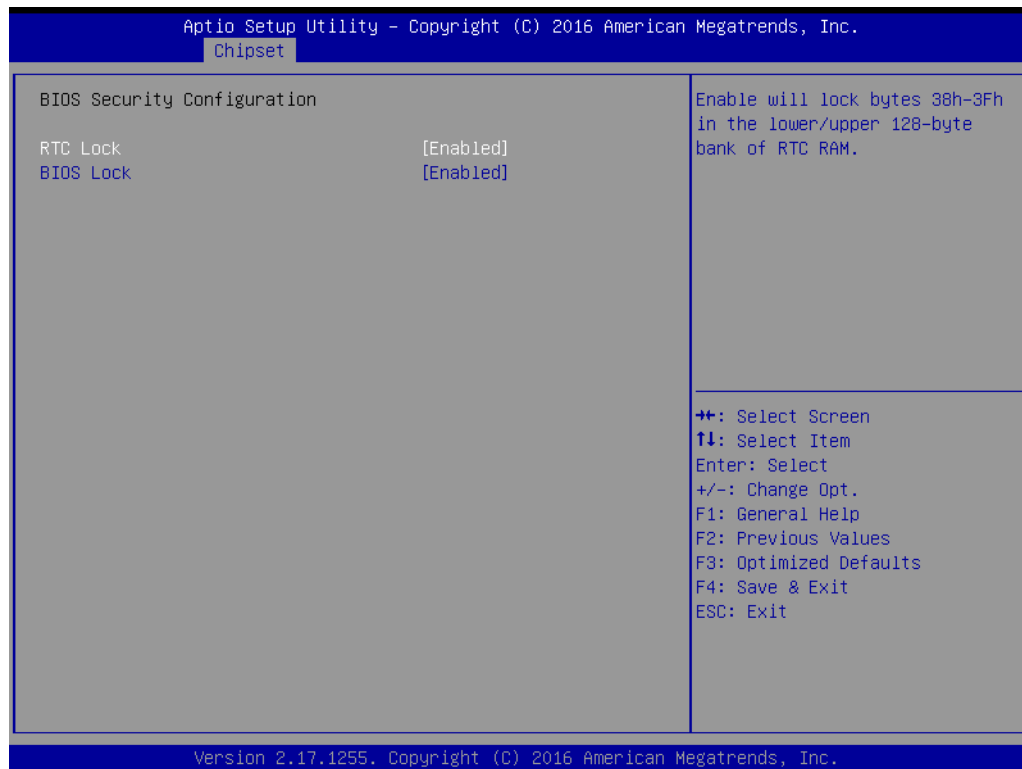

- RTC Lock [Enabled]
Enable will lock bytes 38h-3Fh in the lower/upper 128 byte bank of RTC RAM.
- BIOS Lock [Enabled]

■ HD Audio Configuration



- HD Audio [Auto]
This item is to control detection of the HD-Audio device.
[Disabled] = HAD will be unconditionally disabled.
[Enabled] = HAD will be unconditionally enabled.
[Auto] = HAD will be enabled if present, disabled otherwise.

3.2.4 Security Setting

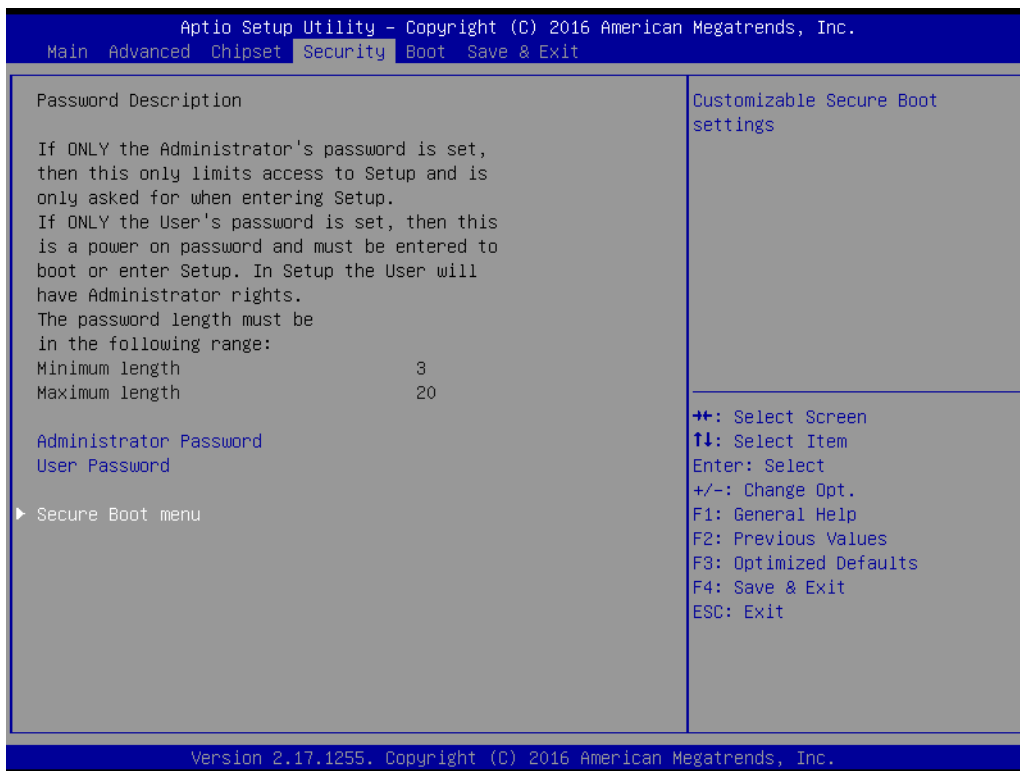

3.2.4.1 Secure Boot menu

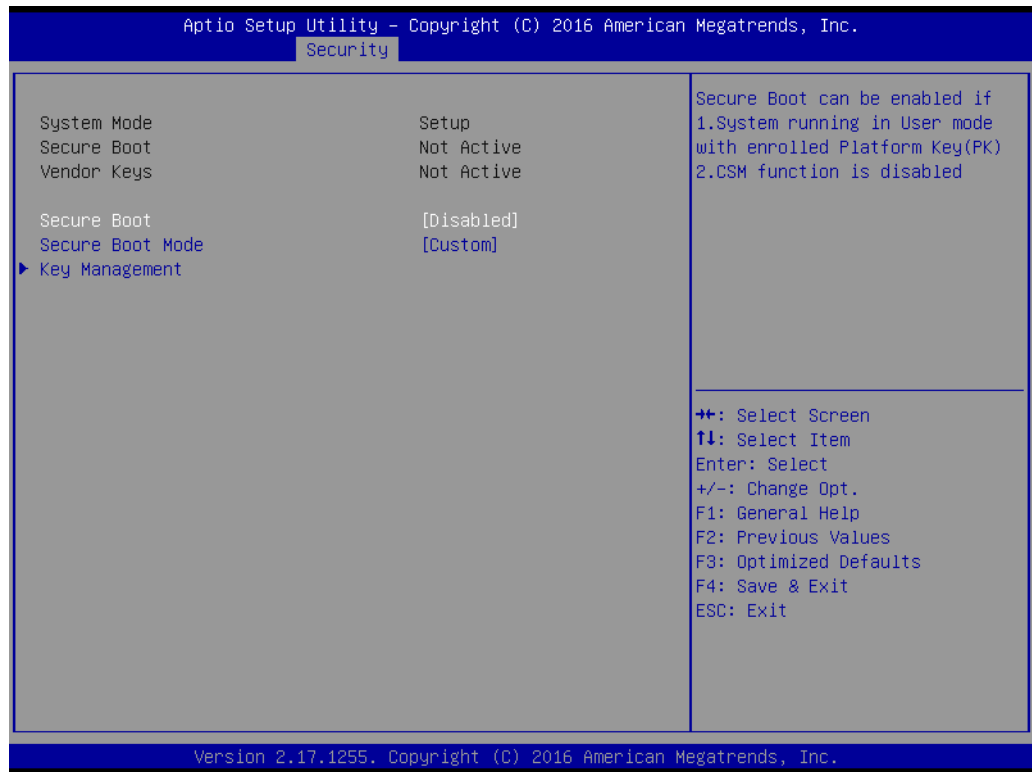

- **Secure Boot [Disabled]**
Secure Boot can be enabled if 2 conditions below:
 1. System is running in user mode with enrolled Platform Key (PK)
 2. CSM function is disabled
- **Secure Boot Mode [Custom]**

3.2.4.2 Key Management

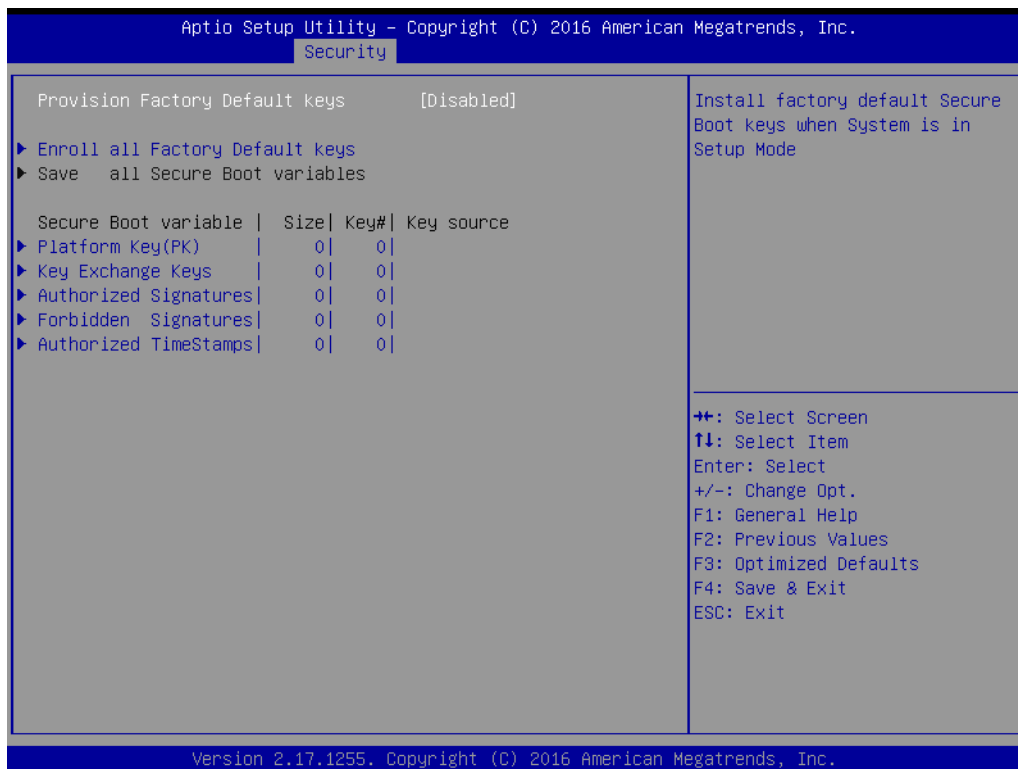

- **Provision Factory Default Keys [Disabled]**
Install factory default Secure Boot Keys when system is in setup mode.

3.2.5 Boot Setting

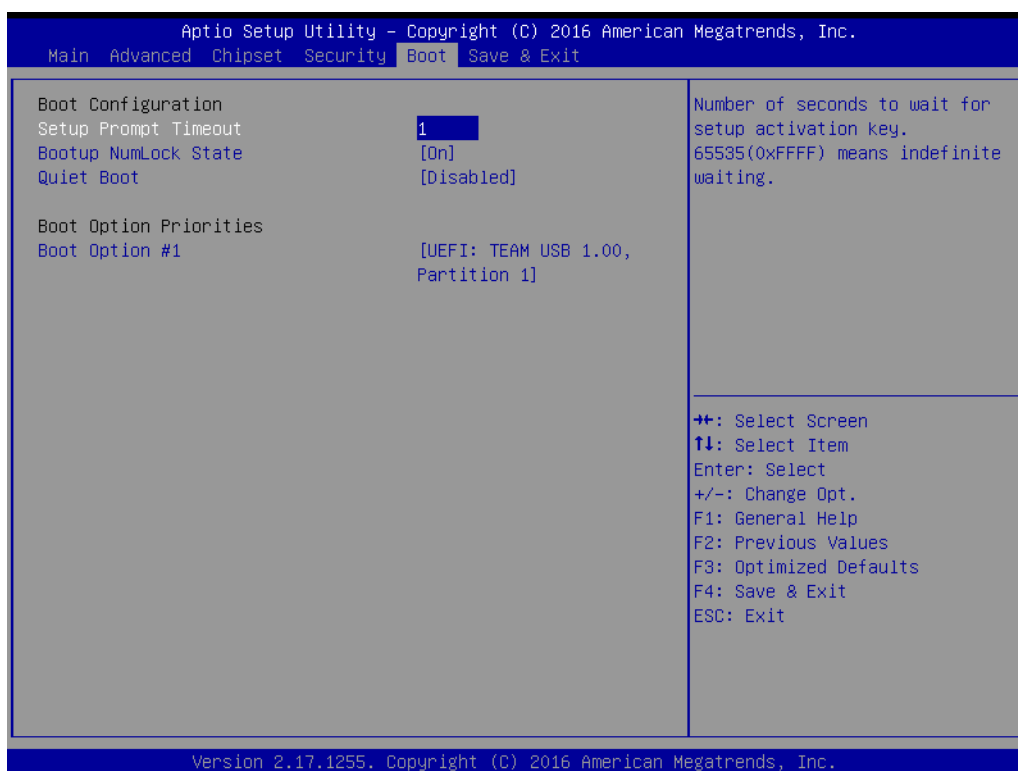

- **Setup Prompt Timeout [1]**

User the <+> and <-> keys to adjust the number of seconds to wait for setup activation key.

- **Bootup NumLock State [On]**
On or Off power on state for the NumLock
- **Quiet Boot [Disabled]**
If this option is set as disabled, the BIOS displays normal POST messages.
If set as enabled, an OEM logo is shown instead of POST messages.
- **Boot Option Priorities**
Choose boot priority from boot device

3.2.6 Save & Exit Configuration

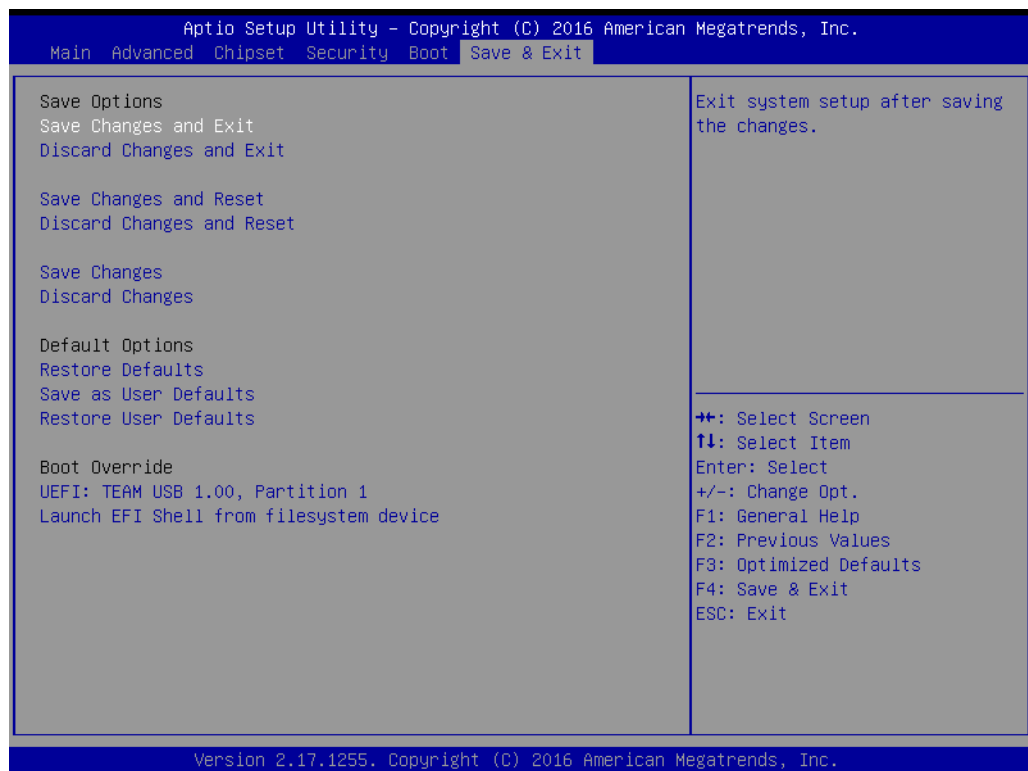

- **Save Changes and Exit**
When users have completed system configuration, select this option to save changes, exit BIOS setup menu and reboot the computer to take effect all system configuration parameters.
 1. Select Exit Saving Changes from the Exit menu and press <Enter>. The following message appears: Save Configuration Changes and Exit Now?
 2. Select [Ok] or [Cancel]
- **Discard Changes and Exit**
Select this option to quit Setup without making any permanent changes to the system configuration.
 1. Select Exit Discarding Changes from the Exit menu and press <Enter>. The following message appears: Discard Changes and Exit Setup Now? [Ok] or [Cancel]
 2. Select Ok to discard changes and exit. Discard Changes
Select Discard Changes from the Exit menu and press <Enter>.

- **Save Changes and Reset**

When users have completed system configuration, select this option to save changes, exit BIOS setup menu and reboot the computer to take effect all system configuration parameters.

1. Select Exit Saving Changes from the Exit menu and press <Enter>. The following message appears: Save Configuration Changes and Exit Now? [Ok] or [Cancel]

2. Select [Ok] or [Cancel]

- **Discard Changes and Reset**

Select this option to quit Setup without making any permanent changes to the system configuration.

1. Select Reset Discarding Changes from the Exit menu and press <Enter>. The following message appears: Discard Changes and Exit Setup Now? [Ok] or [Cancel]

2. Select Ok to discard changes and reset. Discard Changes
Select Discard Changes from the Exit menu and press <Enter>.

- **Restore Default**

The BIOS automatically configures all setup items to optimal settings when users select this option. Defaults are designed for maximum system performance, but may not work best for all computer applications.

In particular, do not use the Defaults if the user's computer is experiencing system configuration problems. Select Restore Defaults from the Exit menu and press <Enter>.

- **Save as User Default**

Save the all current settings as a user default.

- **Restore User Default**

Restore all settings to user default values.

- **Boot Override**

Shows the boot device types on the system.

Chapter 4

Software Introduction
& Service

4.1 Introduction

The mission of Advantech Embedded Software Services is to "Enhance quality of life with Advantech platforms and Microsoft® Windows® embedded technology." We enable Windows® Embedded software products on Advantech platforms to more effectively support the embedded computing community. Customers are freed from the hassle of dealing with multiple vendors (hardware suppliers, system integrators, embedded OS distributors) for projects. Our goal is to make Windows® Embedded Software solutions easily and widely available to the embedded computing community.

4.2 Value-Added Software Services

Software API: An interface that defines the ways by which an application program may request services from libraries and/or operating systems. Provides not only the underlying drivers required but also a rich set of user-friendly, intelligent and integrated interfaces, which speeds development, enhances security and offers add-on value for Advantech platforms. It plays the role of catalyst between developer and solution, and makes Advantech embedded platforms easier and simpler to adopt and operate with customer applications.

4.2.1 Software API

4.2.1.1 Control

GPIO



General Purpose Input/Output is a flexible parallel interface that allows a variety of custom connections. Allows users to monitor the level of signal input or set the output status to switch on/off the device. Our API also provide Programmable GPIO, which allows developers to dynamically set the GPIO input or output status.

SMBus



SMBus is the System Management Bus defined by Intel Corporation in 1995. It is used in personal computers and servers for low-speed system management communications. The SMBus API allows a developer to interface a embedded system environment and transfer serial messages using the SMBus protocols, allowing multiple simultaneous device control.

4.2.1.2 Display

Brightness Control



The Brightness Control API allows a developer to access embedded devices and easily control brightness.

Backlight



The Backlight API allows a developer to control the backlight (screen) on/off in embedded devices.

4.2.1.3 Monitor

Watchdog



A watchdog timer (WDT) is a device that performs a specific operation after a certain period of time if something goes wrong and the system does not recover on its own. A watchdog timer can be programmed to perform a warm boot (restarting the system) after a certain number of seconds.

Hardware Monitor



The Hardware Monitor (HWM) API is a system health supervision API that inspects certain condition indexes, such as fan speed, temperature and voltage.

4.2.1.4 Power Saving

CPU Speed



Makes use of Intel SpeedStep technology to save power consumption. The system will automatically adjust the CPU speed depending on the system loading.

System Throttling

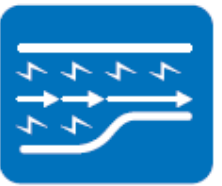

Refers to a series of methods for reducing power consumption in computers by lowering the clock frequency. This API allows the user to adjust the clock from 87.5% to 12.5%.

4.2.2 Software Utility

BIOS Flash

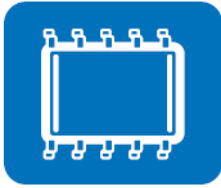

The BIOS Flash utility allows customers to update the flash ROM BIOS version, or use it to back up current BIOS by copying it from the flash chip to a file on customers' disk. The BIOS Flash utility also provides a command line version and an API for fast implementation into customized applications.

Embedded Security ID



The embedded application is the most important property of a system integrator. It contains valuable intellectual property, design knowledge and innovation, but it is easy to be copied! Embedded Security ID utility which provides reliable security functions for customers to secure their application data within embedded BIOS.

Monitoring



The Monitoring is a utility for customer to monitor the system health, like voltage, CPU and system temperature and fan speed. These items are important to a device, if the critical errors occur and are not solved immediately, permanent damage may be caused.

eSOS



The eSOS is a small OS stored in BIOS ROM. It will boot up in case of a main OS crash. It will diagnose the hardware status, and then send an e-mail to the designated administrator. The eSOS also provide for remote connection via Telnet server and FTP server so the administrator can attempt to rescue the system. Note: This function requires BIOS customization.

Chapter 5

Chipset Software
Installation Utility

5.1 Before You Begin

To facilitate the installation of the enhanced display drivers and utility software, read the instructions in this chapter carefully. The drivers for the AIMB-285 are located on Advantech support website: <http://support.advantech.com/support/>. The driver on the support website will guide and link you to the utilities and drivers under a Windows system. Updates are provided via Service Packs from Microsoft*.

Before you begin, it is important to note that most display drivers need to have the relevant software application already installed in the system prior to installing the enhanced display drivers. In addition, many of the installation procedures assume that you are familiar with both the relevant software applications and operating system commands. Review the relevant operating system commands and the pertinent sections of your application software's user manual before performing the installation.

 **Note!** *The driver files on the website are compressed. Do not attempt to install the drivers by copying the files manually. You must download the files and decompress them first. Also, please use the supplied SETUP program to install the drivers.*

5.2 Introduction

The Intel® Chipset Software Installation (CSI) utility installs the Windows INF files that outline to the operating system how the chipset components will be configured. This is needed for the proper functioning of the following features:

- Core PCI PnP services
- Serial ATA interface support
- USB support
- Identification of Intel® chipset components in the Device Manager

 **Note!** *This utility is used for the following versions of Windows, and it has to be installed **before** installing all the other drivers:*

- Windows 7 (32-bit)
- Windows 7 (64-bit)
- Windows 8.1 (32-bit)
- Windows 8.1 (64-bit)
- Windows 10 (32-bit)
- Windows 10 (64-bit)

Chapter 6

Graphic Setup

6.1 Introduction

From 6th Gen Intel Platform, it only has XHCI USB controller for all of USB 2.0 / 3.0 ports. So, when your operation system is Win 7, you need to install USB 3.0 driver manually first. Before you install USB 3.0 driver, all of USB ports can not work properly. So, Please make sure you connect PS/2 keyboard mouse to install the driver first.

For Win8 OS, its inbox driver can enable USB controller and work automatically. You still can download and update WIN8.1 USB 3.0 driver from website.

Here you can download USB 3.0 driver for installation: <http://support.advantech.com/Support/>

6.2 Windows 7/8 driver installation

Note! *If your operation system is Win7, please make sure you insert PS/2 keyboard mouse to install the driver first.*



Download USB 3.0 driver from website to your computer. Click “USB 3.0” folder and chose WIN7 or WIN8 for the driver installation.

01_Chip	2016/2/5 上午 10...	檔案資料夾
02_Graphics	2016/2/3 上午 02...	檔案資料夾
03_Realtek LAN	2016/3/7 上午 10...	檔案資料夾
04_Intel ME_AMT	2016/4/7 下午 01...	檔案資料夾
05_Audio	2016/2/17 下午 0...	檔案資料夾
06_Intel RAID_AHCI	2016/2/3 上午 02...	檔案資料夾
07_Intel USB3.0	2016/2/17 下午 0...	檔案資料夾
08_COM	2016/2/5 上午 10...	檔案資料夾
08_Others	2016/2/5 上午 10...	檔案資料夾

Driver	2015/8/4 上午 07...	檔案資料夾	
Intel(R) USB 3.0 Host Controller Adapt...	2015/8/4 上午 12...	Adobe Acrobat ...	226 KB
mup.xml	2015/8/4 上午 12...	XML Document	7 KB
Readme.txt	2015/8/4 上午 01...	文字文件	44 KB
SetupAdaptationDriver.exe	2015/8/1 上午 11...	應用程式	3,328 KB
Software License Agreement (PV).pdf	2013/3/6 上午 05...	Adobe Acrobat ...	128 KB
WixLicense.txt	2015/6/3 下午 03...	文字文件	13 KB

Chapter 7

LAN Configuration

7.1 Introduction

The AIMB-285 has dual Gigabit Ethernet LANs via dedicated PCI Express x1 lanes Realtek 8111G (LAN1 & LAN2) that offer bandwidth of up to 500 MB/sec, eliminating the bottleneck of network data flows and incorporating Gigabit Ethernet at 1000 Mbps.

7.2 Features

- Integrated 10/100/1000 Mbps transceiver
- 10/100/1000 Mbps triple-speed MAC
- High-speed RISC core with 24-KB cache
- On-chip voltage regulation
- Wake-on-LAN (WOL) support
- PCI Express X1 host interface

7.3 Installation

The AIMB-285's Realtek (LAN1 & LAN2) Gigabit integrated controllers support all major network operating systems. However, the installation procedure varies from system to system. Please find and use the section that provides the driver setup procedure for the operating system you are using.

7.4 Windows® 7/8.1/10 Driver Setup (Realtek 8111G)

Download the driver from support website on your computer and decompressed the file. Select the "Autorun" then navigate to the directory for your OS.

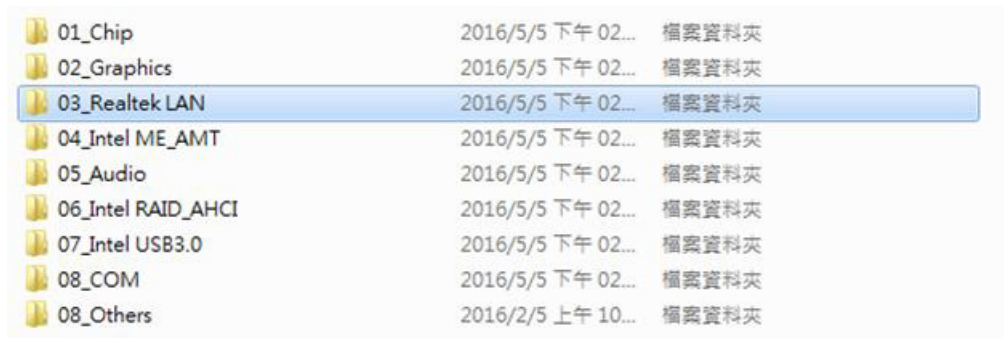

FAQ	2016/5/5 下午 02...	檔案資料夾	
ICON	2016/5/5 下午 02...	檔案資料夾	
QUICK_INSTALL_GUIDE	2016/5/5 下午 02...	檔案資料夾	
README	2016/5/5 下午 02...	檔案資料夾	
TOOL	2016/5/5 下午 02...	檔案資料夾	
UTILIZE_DUAL_MAC_GUIDE	2016/5/5 下午 02...	檔案資料夾	
WIN8	2016/5/5 下午 02...	檔案資料夾	
_Setup.dll	2015/11/5 上午 1...	應用程式擴充	318 KB
AutoInst.exe	2015/11/5 上午 1...	應用程式	87 KB
data1.cab	2015/11/5 上午 1...	WinRAR 壓縮檔	3,471 KB
data1.hdr	2015/11/5 上午 1...	ACDSee 10.0 HD...	35 KB
data2.cab	2015/11/5 上午 1...	WinRAR 壓縮檔	1 KB
EngLangID.txt	2015/11/5 上午 1...	文字文件	1 KB
InstCtrl.txt	2015/11/5 上午 1...	文字文件	1 KB
InstOpt.txt	2015/11/5 上午 1...	文字文件	1 KB
ISSetup.dll	2015/11/5 上午 1...	應用程式擴充	551 KB
layout.bin	2015/11/5 上午 1...	BIN 檔案	1 KB
setup.exe	2015/11/5 上午 1...	應用程式	392 KB
setup.ini	2015/11/5 上午 1...	組態設定	1 KB
setup.inx	2015/11/5 上午 1...	INX 檔案	267 KB
setup.isn	2015/11/5 上午 1...	ISN 檔案	41 KB
setup.iss	2015/11/5 上午 1...	ISS 檔案	1 KB
setupctrl.txt	2015/11/5 上午 1...	文字文件	1 KB

Appendix **A**

I/O Pin Assignments

A.1 DC input Phoenix Connector

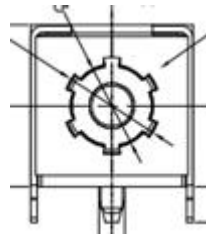

Pin	Signal	Pin	Signal
1	VCC(12V)	2	GND

A.2 Display Port

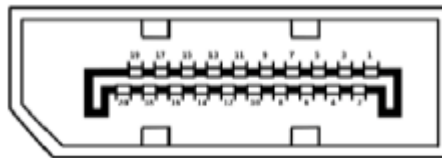

Pin	Signal	Pin	Signal
1	DP1_0+	11	GND
2	GND	12	DP1_3-
3	DP1_0-	13	DP1_AUX_EN#
4	DP1_1+	14	GND
5	GND	15	DP1_AUX+
6	DP1_1-	16	GND
7	DP1_2+	17	DP1_AUX-
8	GND	18	DP1_HPD
9	DP1_2-	19	GND
10	DP1_3+	20	+V3.3_DP1

A.3 High Definition Multimedia Interface

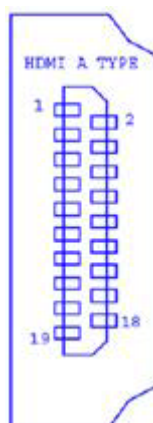

Pin	Signal	Pin	Signal
1	HDMI1_Z_D2+	11	GND
2	GND	12	HDMI1_Z_CLK-
3	HDMI1_Z_D2-	13	x
4	HDMI1_Z_D1+	14	x
5	GND	15	HDMI1_SCL
6	HDMI1_Z_D1-	16	HDMI1_SDA
7	HDMI1_Z_D0+	17	GND
8	GND	18	+V5_HDMI
9	HDMI1_Z_D0-	19	HDMI1_HPD
10	HDMI1_Z_CLK+	20	x

A.4 ATX Power supply (5VSB) connector



Pin	Signal
1	+V5SB
2	GND
3	PS_ON#

A.5 USB 3.0 Stack Connector



Pin	Signal	Pin	Signal
1	+5V	10	+5V
2	D0-	11	D1-
3	D0+	12	D1+
4	GND	13	GND
5	RX0-	14	RX1-
6	RX0+	15	RX1+
7	GND	16	GND
8	TX0-	17	TX1-
9	TX0+	18	TX1+

A.6 RJ45 2 Port

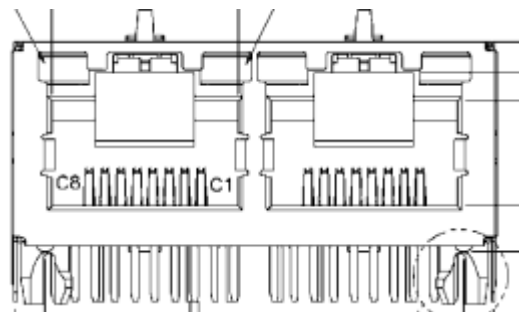

Pin	Signal	Pin	Signal
B1	MDI_LAN1_DP0	A1	LAN2_MDI0+
B2	MDI_LAN1_DN0	A2	LAN2_MDI0-
B3	MDI_LAN1_DP1	A3	LAN2_MDI1+
B4	MDI_LAN1_DN1	A4	LAN2_MDI1-
B5	LAN1_CONN	A5	LAN2_CONNved
B6	LAN1_CT	A6	LAN2_CT
B7	MDI_LAN1_DP2	A7	LAN2_MDI2+
B8	MDI_LAN1_DN2	A8	LAN2_MDI2-
B9	MDI_LAN1_DP3	A9	LAN2_MDI3+
B10	MDI_LAN1_DN3	A10	LAN2_MDI3-
B11	LAN1_LED0_ACT#	A11	LAN2_LED1_ACT#
B12	+V3.3_DUAL	A12	+V3.3_DUAL
B13	LAN1_LED1_1G#	A13	LAN2_LED2_1G#
B14	LAN1_LED2_100M#	A14	LAN2_LED0_100M#

A.7 Battery Wafer Box



Pin	Signal
1	VBAT
2	GND

A.8 HD Analog Audio Interface

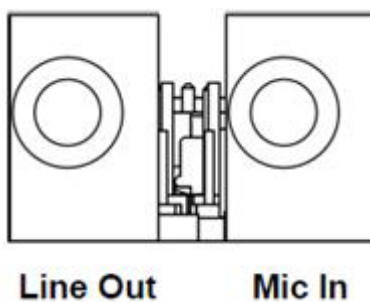

AUDIO1: LINE-OUT
AUDIO2: MIC

A.9 Front HD Analog Audio Interface

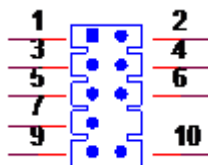

Pin	Signal	Pin	Signal
1	MIC IN L	2	GND
3	MIC IN R	4	FPAUD_DETECT#
5	LINE OUT R	6	SENSE R1
7	SENSE	8	KEY
9	LINE OUT L	10	SENSE R2

B11	WAKE#	A11	PWRGD
B12	Reserved	A12	GND
B13	GND	A13	REFCLK+
B14	TX0+	A14	REFCLK-
B15	TX0-	A15	GND
B16	GND	A16	RX0+
B17	Reserved	A17	RX0-
B18	DETECT#	A18	GND
B19	TX1+	A19	CONFIG1
B20	TX1-	A20	GND
B21	GND	A21	RX1+
B22	GND	A22	RX1-
B23	TX2+	A23	GND
B24	TX2-	A24	GND
B25	GND	A25	RX2+
B26	GND	A26	RX2-
B27	TX3+	A27	GND
B28	TX3-	A28	GND
B29	GND	A29	RX3+
B30	Reserved	A30	RX3-
B31	Reserved	A31	GND
B32	GND	A32	CONFIG2

A.13 MINIPCIIE and 3G Connector

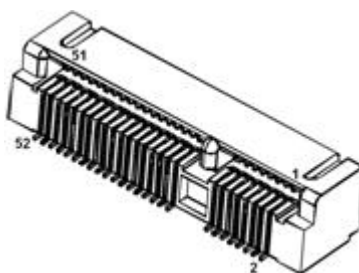

Pin	Signal	Pin	Signal
1	WAKE#	2	+3.3Vaux
3	Reserved	4	GND
5	Reserved	6	+1.5V
7	CLKREQ#	8	UIM_PWR
9	GND	10	UIM_DATA
11	REFCLK-	12	UIM_CLK
13	REFCLK+	14	UIM_RESET
15	GND	16	UIM_VPP
17	Reserved	18	GND
19	Reserved	20	DISABLE#
21	DETECT#	22	RESET#
23	PCIE_RX+	24	+3.3Vaux

25	PCIE_RX-	26	GND
27	GND	28	+1.5V
29	GND	30	SMB_CLK
31	PCIE_TX-	32	SMB_DATA
33	PCIE_TX+	34	GND
35	GND	36	USB_D-
37	GND	38	USB_D+
39	+3.3Vaux	40	GND
41	+3.3Vaux	42	Reserved
43	V1.2_DETECT#	44	LED_WLAN#
45	Reserved	46	Reserved
47	Reserved	48	+1.5V
49	Reserved	50	GND
51	Reserved	52	+3.3Vaux

A.14 USB 2.0 Connector

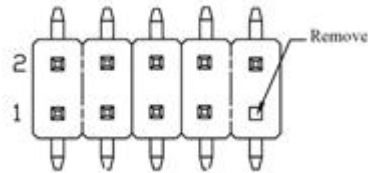

Pin	Signal	Pin	Signal
1	+5V	2	+5V
3	D-	4	D-
5	D+	6	D+
7	GND	8	GND
9	Key	10	x

A.15 SATA Signal Connector

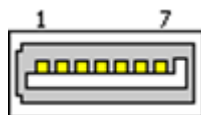

Pin	Signal
1	GND
2	TX+
3	TX-
4	GND
5	RX-
6	RX+
7	GND

A.16 LVDS Backlight Inverter Power Connector



Pin	Signal
1	+12V
2	GND
3	BKL_EN
4	BKL_CTRL
5	+5V

A.17 General Purpose I/O Pin Header

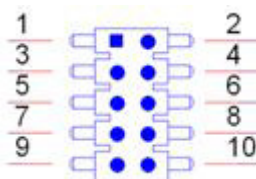

Pin	Signal	Pin	Signal
1	GPIO0	2	GPIO4
3	GPIO1	4	GPIO5
5	GPIO2	6	GPIO6
7	GPIO3	8	GPIO7
9	+3.3V	10	GND

A.18 COM Port



Pin	Signal	Pin	Signal
1	TX-	2	DSR#
3	TX+	4	RTS#
5	RX-	6	CTS#
7	RX+	8	RI#
9	GND		

A.19 PS/2 Keyboard and Mouse Connector



Pin	Signal	Pin	Signal
1	KB CLK	2	KB DATA
3	MS CLK	4	GND
5	+5V	6	MS DATA

A.20 Low Pin Count Header

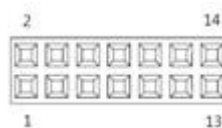

Pin	Signal	Pin	Signal
1	CLK_33M	2	AD1
3	RESET#	4	AD0
5	FRAME#	6	+3.3V
7	AD3	8	GND
9	AD2	10	SMB_CLK
11	SERIRQ	12	SMB_DATA
13	+5VSB	14	+5V

A.21 SYSTEM FAN Power Connector

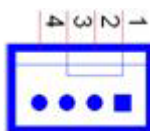

Pin	Signal
1	GND
2	+12V
3	DETECT
4	PWM IN

A.22 SPI Programming Pin Header

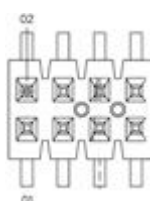

Pin	Signal	Pin	Signal
1	CS#	2	+3.3V
3	MISO	4	X
5	X	6	SCK
7	GND	8	MOSI

A.23 SPI BIOS Flash Socket

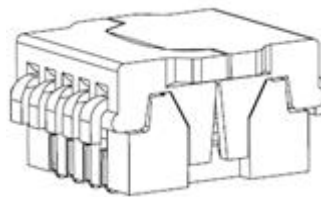
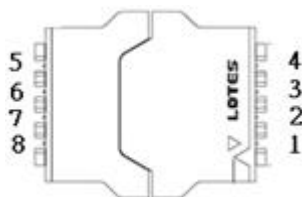

Pin	Signal	Pin	Signal
1	CS#	5	MOSI
2	MISO	6	SCK
3	WP# / IO2	7	HOLD# / IO3
4	GND	8	+3.3V

A.24 CPU FAN Power Connector

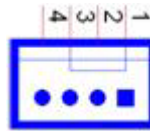

Pin	Signal
1	GND
2	+12V
3	DETECT
4	PWM IN

A.25 SMBUS Programming INFINEON for +Vcore Controller

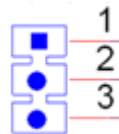

Pin	Signal
1	INF_SMBCLK
2	INF_SMBDATA
3	GND

A.26 MINIPCIE and mSATA Connector

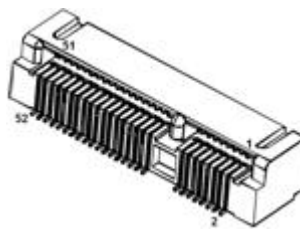

MINIPCIE:

Pin	Signal	Pin	Signal
1	WAKE#	2	+3.3Vaux
3	Reserved	4	GND
5	Reserved	6	+1.5V
7	CLKREQ#	8	Reserved
9	GND	10	Reserved
11	REFCLK-	12	Reserved
13	REFCLK+	14	Reserved
15	GND	16	Reserved

17	Reserved	18	GND
19	Reserved	20	DISABLE#
21	DETECT#	22	RESET#
23	PCIE_RX+	24	+3.3Vaux
25	PCIE_RX-	26	GND
27	GND	28	+1.5V
29	GND	30	SMB_CLK
31	PCIE_TX-	32	SMB_DATA
33	PCIE_TX+	34	GND
35	GND	36	USB_D-
37	GND	38	USB_D+
39	+3.3Vaux	40	GND
41	+3.3Vaux	42	Reserved
43	V1.2_DETECT#	44	LED_WLAN#
45	Reserved	46	Reserved
47	Reserved	48	+1.5V
49	Reserved	50	GND
51	MSATA_DETECT#	52	+3.3Vaux

mSATA:

Pin	Signal	Pin	Signal
1	Reserved	2	+3.3V
3	Reserved	4	GND
5	Reserved	6	+1.5V
7	Reserved	8	Reserved
9	GND	10	Reserved
11	Reserved	12	Reserved
13	Reserved	14	Reserved
15	GND	16	Reserved
17	Reserved	18	GND
19	Reserved	20	Reserved
21	DETECT#	22	Reserved
23	RX+	24	+3.3V
25	RX-	26	GND
27	GND	28	+1.5V
29	GND	30	SMB_CLK
31	TX-	32	SMB_DATA
33	TX+	34	GND
35	GND	36	Reserved
37	GND	38	Reserved
39	+3.3V	40	GND
41	+3.3V	42	Reserved
43	Reserved	44	Reserved
45	Reserved	46	Reserved
47	Reserved	48	+1.5V
49	Reserved	50	GND
51	MSATA_DETECT#	52	+3.3V

A.27 Video Graphics Array Connector

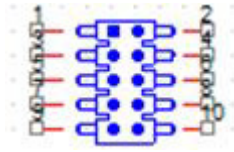

Pin	Signal	Pin	Signal
1	RED	2	SCL
3	GREEN	4	x
5	BLUE	6	SDA
7	VSYNC	8	GND
9	HSYNC	10	+V5

A.28 SATA Power Connector

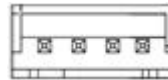

Pin	Signal	Pin	Signal
1	+V5	3	GND
2	GND	4	+V12

A.29 LVDS Panel Connector

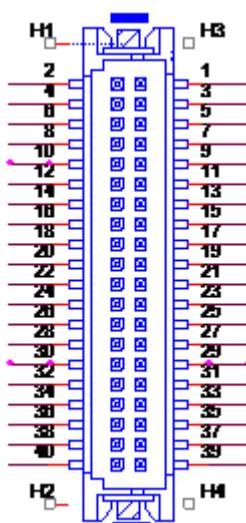

Pin	Signal	Pin	Signal
1	VDD	2	VDD
3	LVDS_DET#	4	GND
5	VDD	6	VDD
7	OD0-	8	ED0-
9	OD0+	10	ED0+
11	GND	12	GND
13	OD1-	14	ED1-
15	OD1+	16	ED1+
17	GND	18	GND
19	OD2-	20	ED2-
21	OD2+	22	ED2+
23	GND	24	GND
25	OCK-	26	ECK-
27	OCK+	28	ECK+
29	GND	30	GND
31	DDC_CLK	32	DDC_DAT
33	GND	34	GND
35	OD3-	36	ED3-
37	OD3+	38	ED3+
39	LVDS_ENBKL	40	VCON

Please connect Pin3 to any GND pin on LVDS panel to enable LVDS.

A.30 ATX 12V Power Supply Connector



Pin	Signal
1	GND
2	GND
3	+12V
4	+12V

A.31 SIM Card Connector



Pin	Signal
1	UIM_PWR
2	UIM_RESET
3	UIM_CLK
4	Reserved
5	GND
6	UIM_VPP
7	UIM_DATA
8	Reserved

ADVANTECH

Enabling an Intelligent Planet

www.advantech.com

Please verify specifications before quoting. This guide is intended for reference purposes only.

All product specifications are subject to change without notice.

No part of this publication may be reproduced in any form or by any means, electronic, photocopying, recording or otherwise, without prior written permission of the publisher.

All brand and product names are trademarks or registered trademarks of their respective companies.

© Advantech Co., Ltd. 2016