

# Ultra Small Surface Mount Coaxial Connectors - Low Profile 1.9mm or 2.4mm Mated Height

## U.FL Series

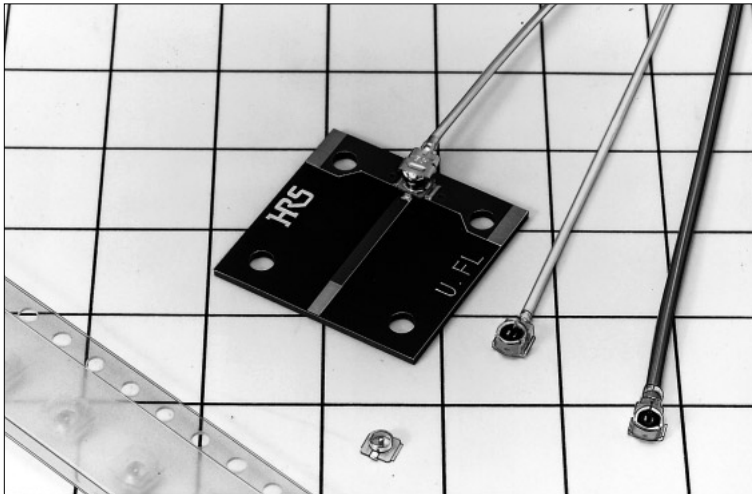

### Up to 6GHz Transmission Speed

#### Mated Height Comparison (With E.FL series)

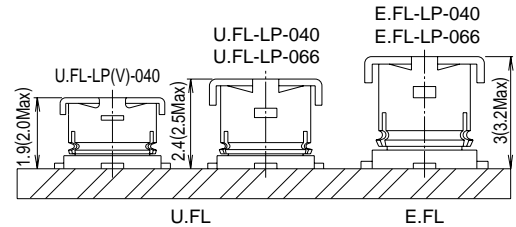

### ■ Features

#### 1. Extremely Small Occupied Mounting Area

Reduced board space requirement by 18% to 7.7mm<sup>2</sup>, when compared with Hirose's E.FL connectors.

#### 2. Light Weight

One of the world's lightest coaxial connectors.  
Receptacle: 15.7mg

#### 3. Frequencies of Up to 6GHz

To meet the frequency requirements of a wide variety of miniature equipment, these connectors offer high frequency performance from DC to 6 GHz.

#### 4. Board Placement with Automatic Equipment

Supplied on tape-and-reel packaging.

#### 5. Use of Ultra-fine Teflon Cable

Several of ultra-fine single and double shielded Teflon<sup>®</sup> coaxial cables terminate to U.FL plug.

#### 6. Simple Disconnection

Dedicated tool allows reliable un-mating of the plug.

#### 7. User Friendly Mating Operation

Tactile lock feeling ensures and confirms reliable connection.

### ■ Applications

Mobile phones, Wireless LAN, Mini-PCI, Bluetooth, PDA, GPS, electronic measuring instruments, etc.

### ● Space Factor of Mated Connector

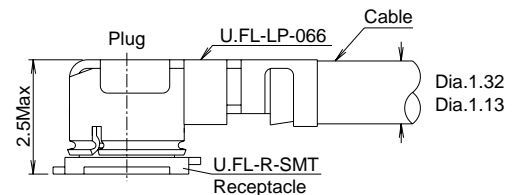
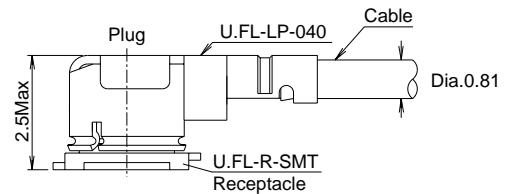

**NEW**

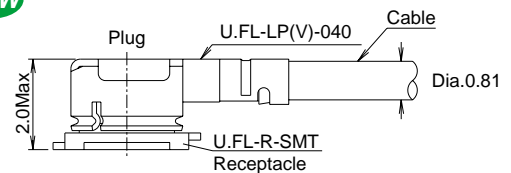

**NEW**

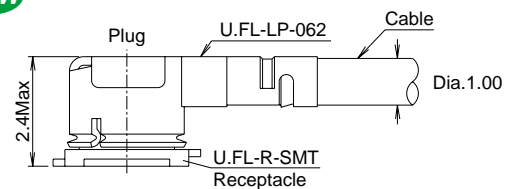

**NEW**

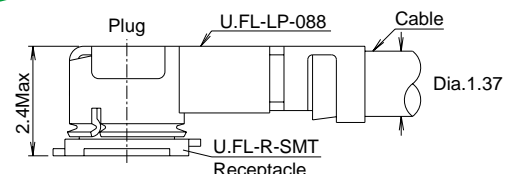

\*Teflon is a registered trademark of DuPont.

## ■ Product Specifications

Ratings	Nominal characteristic impedance Voltage rating Frequency range	50 ohms 60 V AC (rms) DC to 6 GHz	Operating temperature range Operating humidity	-40°C to +90°C 90% max.
---------	-----------------------------------------------------------------------	-----------------------------------------	---------------------------------------------------	----------------------------

Item	Specification	Conditions	
1. Contact resistance	Center: 20 m ohms max. Outside: 10 m ohms max.	10 mA max.	
2. Insulation resistance	500 M ohms min.	100 V DC	
3. Withstanding voltage	No flashover or insulation breakdown.	200 V AC / 1 minute	
4. V.S.W.R.*	Part No.	Up to 3GHz	3 to 6GHz
	U.FL-LP-040 dia.0.81mm Coaxial Cable Assembly	1.3 Max	1.35 Max
	U.FL-LP(V)-040 dia.0.81mm Coaxial Cable Assembly	1.3 Max	1.3 Max
	U.FL-LP-068 dia.1.13mm Coaxial Cable Assembly	1.3 Max	1.4 Max
	U.FL-LP-066 dia.1.32mm Coaxial Cable Assembly	1.3 Max	1.5 Max
	U.FL-LP-062 dia.1mm Coaxial Cable Assembly	1.3 Max	1.3 Max
	U.FL-LP-088 dia.1.37mm Coaxial Cable Assembly	1.3 Max	1.4 Max
5. Center contact holding force	0.15 N min.	Measured with a $\phi$ 0.475 pin gauge	
6. Durability (mating/un-mating, with corresponding plug)	Contact resistance Center: 25 m ohms max. Outside: 15 m ohms max.	30 cycles	
7. Vibration	No electrical discontinuity of 1 $\mu$ s min.	Frequency: 10 to 100 Hz, single amplitude of 1.5mm, acceleration of 59m/s <sup>2</sup> , for 5 cycles in the direction of each of the 3 axis.	
8. Shock	No damage, cracks or parts dislocation.	Acceleration of 735 m/s <sup>2</sup> , 11ms duration, sine half-wave waveform, 6 cycles in each of 3 axes.	
9. Humidity (Steady state)	No damage, cracks or parts dislocation. Insulation resistance 100 M ohms min.(when humidity high) Insulation resistance 500 M ohms min.(when dry)	96 hours at temperature of 40°C and humidity of 95%.	
10. Temperature cycle	No damage, cracks or parts dislocation. Contact resistance:25 m ohms max. (Center) 15 m ohms max. (Outside)	Temperature:-40°C→+5 to +35°C→+90°C→+5 to +35°C Time: 30 → 5 max. →30 →5 max.(Minutes) 5 cycles	
11. Salt spray test	No excessive corrosion	5% salt water solution, 48 hours	

\*V.S.W.R. Measurement System

The above V.S.W.R. standard values were measured using the measurement connection shown below.

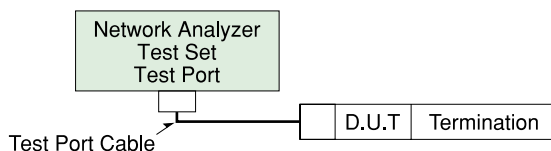

Note 1: Cable type connectors were measured with SMA conversion adapters attached to both ends of the harness product of a suitable 100cm cable.

Note 2: Board type connectors were mounted to a 50 $\Omega$  glass epoxy board and measurements were conducted with SMA conversion adapters attached.

## ■ Material/Finishes

Part	Material		Finish	Remarks
Shell	Phosphor bronze		Silver plated	_____
Male center contact	Brass		Gold plated	_____
Female center contact	Phosphor bronze		Gold plated	_____
Insulator	Plug	PBT	Color: Black	UL94V-0
	Receptacle	LCP	Color: Beige	UL94V-0

## ■ Receptacles

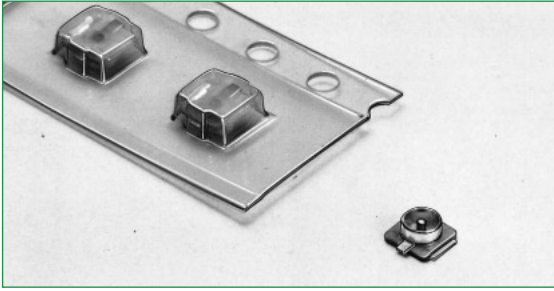

Note 1: Receptacles of (01) specification are sold by the bag with 100 pieces per bag.  
Please order in pack units.

Note 2: Receptacles of (10) specification are sold by the reel (which contains 2,500 pieces).  
Please order in reel units.

Note 3: This area may be covered by insulating material.

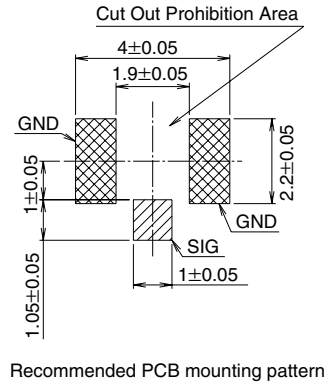
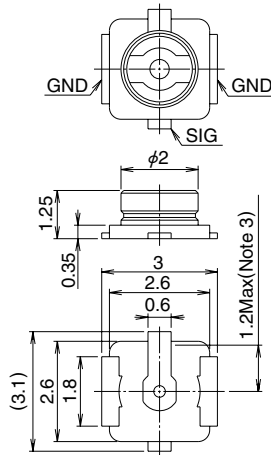

Part No.	CL No.	Packaging	Weight (mg)
U.FL-R-SMT(01)	331-0471-0-01	Bag packaging (100 pieces/bag)	15.7/unit
U.FL-R-SMT(10)	331-0471-0-10	Reel packaging (2500 pieces/reel)	

## ● Packaging Specifications

### Embossed Carrier Tape Dimensions

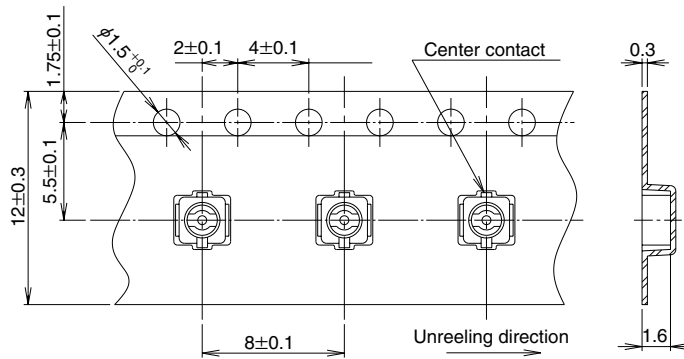

### Reel Dimensions

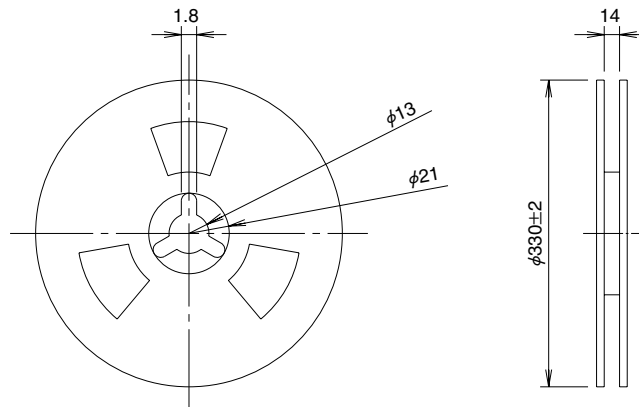

## ■ Cable Assembly (Plug)

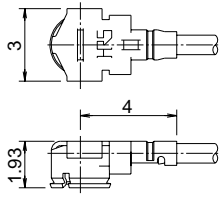
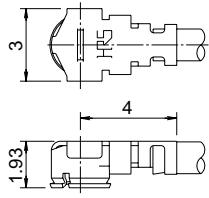
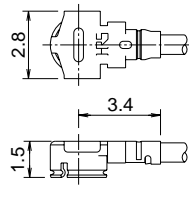
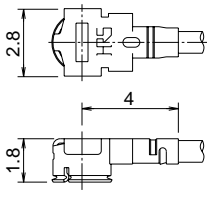
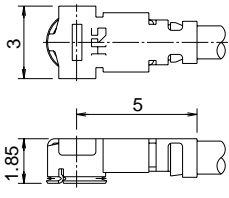
Part No.	U.FL-LP-040	U.FL-LP-066	U.FL-LP(V)-040	U.FL-LP-062	U.FL-LP-088
					
Mated Height	2.5mm Max. (2.4mm Nom.)	2.5mm Max. (2.4mm Nom.)	2.0mm Max. (1.9mm Nom.)	2.4mm Max. (2.3mm Nom.)	2.4mm Max. (2.3mm Nom.)
Applicable cable	Dia. 0.81mm Coaxial cable	Dia. 1.13mm and Dia. 1.32mm Coaxial cable	Dia. 0.81mm Coaxial cable	Dia. 1mm Coaxial cable	Dia. 1.37mm Coaxial cable
Weight (mg)	53.7	59.1	34.8	45.5	71.7

## ● Cable Guide

Description	Cable Type	Cable Specification						
		Inner Conductor*	Dielectric Diameter	Outer Conductor*	Jacket Diameter	Nominal Impedance	Nominal attenuation	
							At 3GHz	At 6GHz
Dia.0.81mm Coaxial Cable	04	7/0.05 SA (AWG36)	Dia.0.40 PFA	Single Shield SA	Dia.0.81 PFA	50 ohms	6.45dB/m	9.42dB/m
Dia.1.13mm Coaxial Cable	068	7/0.08 SA (AWG32)	Dia.0.68 FEP	Single Shield SA[TA]	Dia.1.13 FEP	50 ohms	3.43dB/m [3.73dB/m]	5.13dB/m [5.44dB/m]
Dia.1.32mm Coaxial Cable	066	7/0.08 SA (AWG32)	Dia.0.66 FEP	Double Shield TA	Dia.1.32 FEP	50 ohms	3.8dB/m	5.6dB/m
Dia.1mm Coaxial Cable	062	7/0.071 SA (AWG33)	Dia.0.62 FEP	Tape, single Shield TAT	Dia.1 FEP	50 ohms	3.1dB/m	4.4dB/m
Dia.1.37mm Coaxial Cable	088	7/0.102 SA (AWG30)	Dia.0.88 FEP	Single Shield TA	Dia.1.37 FEP	50 ohms	2.8dB/m	4.3dB/m

(data as provided by cable suppliers, for reference only)

\* SA : Silver plated annealed copper wire, TA : Tin plated annealed copper wire, TAT : Tin plated copper wire alloyed with tin

## How to Specify Plug Cable Assembly

Dimensions of U.FL Series assembly products should be made as indicated below.

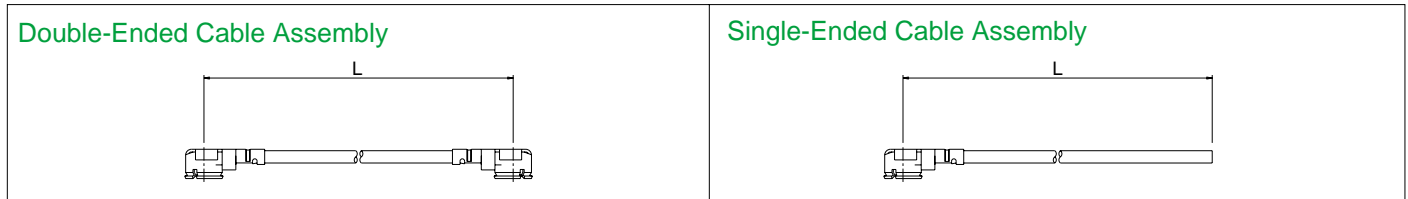

### Ordering Information

**U.FL - [ ] LP - [ ] - A - (L)**

①                      ②                      ③                      ④

① Series name	U.FL
② Assembly type	LP: Single ended 2LP: Double ended
③ Cable type	04 : Dia.0.81mm Coaxial Cable 068 : Dia.1.13mm Coaxial Cable 066 : Dia.1.32mm Coaxial Cable 062 : Dia.1 mm Coaxial Cable 088 : Dia.1.37mm Coaxial Cable
④ Total Length(mm)	Length is expressed in mm units.

### Total Standard Tolerance for Total Length of Cable Assembly

Total Length(mm)	Standard Tolerance (mm)
35 ≤ L ≤ 200	± 4
200 < L ≤ 500	± 8
500 < L ≤ 1000	±12
1000 < L	±1.5%

Note: Shortest length L is 35 mm.

Part No. of Plug	Part No. of Cable Assembly	Description
U.FL-LP-040	U.FL-2LP-04N1-A-(L)	Dia. 0.81mm double ended coaxial cable, color: white
	U.FL-2LP-04N2-A-(L)	Dia. 0.81mm double ended coaxial cable, color: black
	U.FL-LP-04N1-A-(L)	Dia. 0.81mm single ended coaxial cable, color: white
	U.FL-LP-04N2-A-(L)	Dia. 0.81mm single ended coaxial cable, color: black
U.FL-LP-068	U.FL-2LP-068N1-A-(L)	Dia. 1.13mm double ended coaxial cable, color: gray
	U.FL-2LP-068N2-A-(L)	Dia. 1.13mm double ended coaxial cable, color: black
	U.FL-LP-068N1-A-(L)	Dia. 1.13mm single ended coaxial cable, color: gray
	U.FL-LP-068N2-A-(L)	Dia. 1.13mm single ended coaxial cable, color: black
U.FL-LP-066	U.FL-2LP-066J1-A-(L)	Dia. 1.32mm double ended coaxial cable, color: gray
	U.FL-2LP-066J2-A-(L)	Dia. 1.32mm double ended coaxial cable, color: black
	U.FL-LP-066J1-A-(L)	Dia. 1.32mm single ended coaxial cable, color: gray
	U.FL-LP-066J2-A-(L)	Dia. 1.32mm single ended coaxial cable, color: black
U.FL-LP(V)-040	U.FL-2LP(V)-04N1-A-(L)	Dia. 0.81mm double ended coaxial cable, color: white
	U.FL-2LP(V)-04N2-A-(L)	Dia. 0.81mm double ended coaxial cable, color: black
	U.FL-LP(V)-04N1-A-(L)	Dia. 0.81mm single ended coaxial cable, color: white
	U.FL-LP(V)-04N2-A-(L)	Dia. 0.81mm single ended coaxial cable, color: black
U.FL-LP-062	U.FL-2LP-062N1D-A-(L)	Dia. 1mm double ended coaxial cable, color: gray
	U.FL-2LP-062N2D-A-(L)	Dia. 1mm double ended coaxial cable, color: black
	U.FL-LP-062N1D-A-(L)	Dia. 1mm single ended coaxial cable, color: gray
	U.FL-LP-062N2D-A-(L)	Dia. 1mm single ended coaxial cable, color: black
U.FL-LP-088	U.FL-2LP-088K1T-A-(L)	Dia. 1.37mm double ended coaxial cable, color: gray
	U.FL-2LP-088K2T-A-(L)	Dia. 1.37mm double ended coaxial cable, color: black
	U.FL-LP-088K1T-A-(L)	Dia. 1.37mm single ended coaxial cable, color: gray
	U.FL-LP-088K2T-A-(L)	Dia. 1.37mm single ended coaxial cable, color: black

Please contact Hirose Sales Representative for cable length and cable end treatment.

## ■ Conversion Adapters

### ● SMA Conversion Adapter

(Mating portion: U.FL side jack - SMA side plug)



Note: The U.FL side mating portions has a lower lock retention force than the regular product, therefore, cannot be used for purposes other than performance measurements.

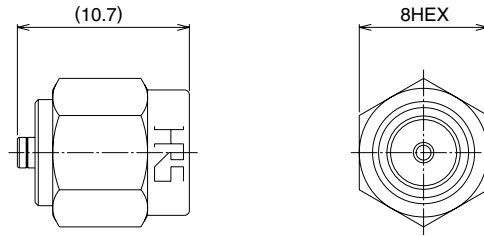

Part No.	CL No.
HRMP-U.FLJ	311-0300-2

### ● SMA Conversion Adapter

(Mating portion: U.FL side plug - SMA side jack)



Note: The U.FL side mating portions has a lower lock retention force than the regular product, therefore, cannot be used for purposes other than performance measurements.

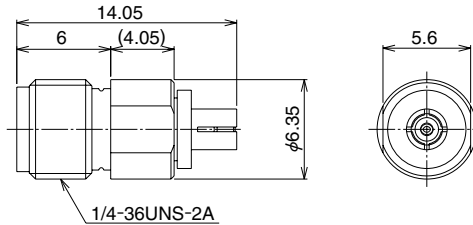

Part No.	CL No.
HRMJ-U.FLP	311-0301-5

### ● SMA Conversion Adapter

(Mating portion: U.FL side plug-SMA side jack)



Note: This connector is used by compressing the mated portion of U.FL side onto the U.FL-R-SMT portion.

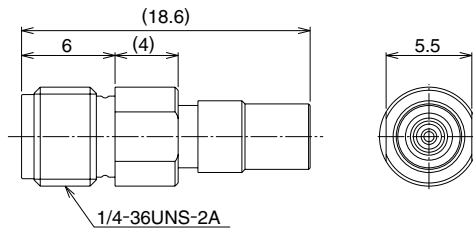

Part No.	CL No.
HRMJ-U.FLP-ST1	311-0385-5

## ■ Receptacle Inspection

This receptacle is used for inspecting the continuity, withstand voltage, and other aspects of the harness product.



This receptacle is used for check the continuity, withstanding voltage, and other performance of the cable assembly products.

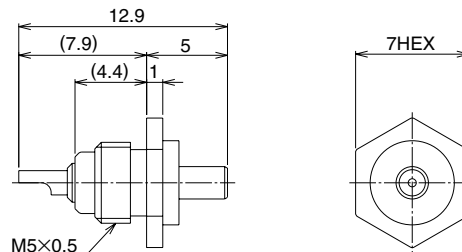

Part No.	CL No.
U.FL-R-1	331-0466-0

## ■ Plug Extraction Tool

This jig is used for extraction from a mating condition.



Note: Part No. U.FL-LP-N-2 for U.FL-LP-040/066/088.  
Part No. U.FL-LP(V)-N-2 for U.FL-LP(V)-040/U.FL-LP-062.

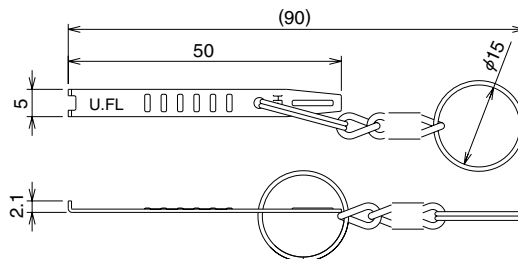

Part No.	CL No.
U.FL-LP-N-2	331-0494-5
U.FL-LP(V)-N-2	331-0493-2

## Usage Precautions

### 1. Plugs

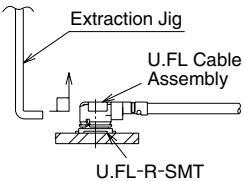
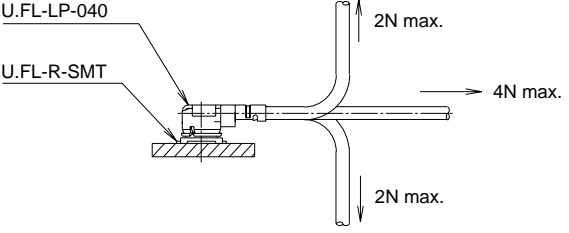
<p>(1) Connection/ disconnection of connectors</p>	<p>1) To disconnect connectors, insert the end portion of U.FL-LP-N-2 and U.FL-LP(V)-N-2 under the connector flanges and pull off vertically, in the direction of the connector mating axis.</p> <p>2) To mate the connectors, the mating axes of both connectors must be aligned and the connectors can be mated. The "click" will confirm fully mated connection. Do not attempt to insert on an extreme angle.</p> 
<p>(2) Permissible load on the cable after connector are mated.</p>	<p>After the connectors are mating, do not apply a load to the cable in excess of the values indicated in the diagram below.</p> 
<p>(3) Precautions</p>	<p>Do NOT forcefully twist or deform wires.</p>

### 2. Receptacles

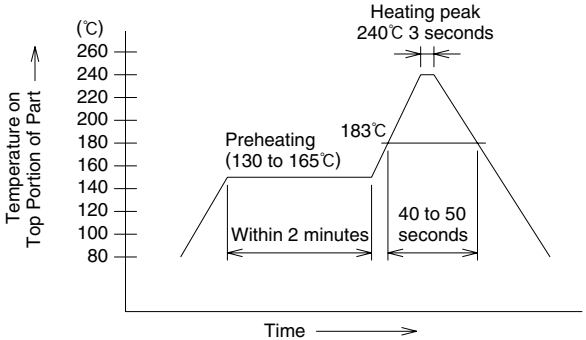
<p>(1) Recommended soldering temperature profile</p>	 <p>1) The temperature profile indicates the board surface temperature at the point of contacts with the connector terminals.</p> <p>2) The temperature profile will change depending on conditions which include such factors as the size of the board, the solder used, and the solder thickness.</p>
<p>(2) Recommended manual soldering</p>	<p>Manual soldering: 350°C for 5 seconds</p>
<p>(3) Recommended screen thickness</p>	<p>0.1 to 0.15 mm</p>