

THIS DOCUMENT IS THE PROPERTY OF KEYSTONE ELECTRONICS CORP. AND SHALL NOT BE REPRODUCED, DISTRIBUTED OR USED AS A BASIS FOR MANUFACTURE WITHOUT PRIOR WRITTEN PERMISSION FROM KEYSTONE ELECTRONICS CORP.

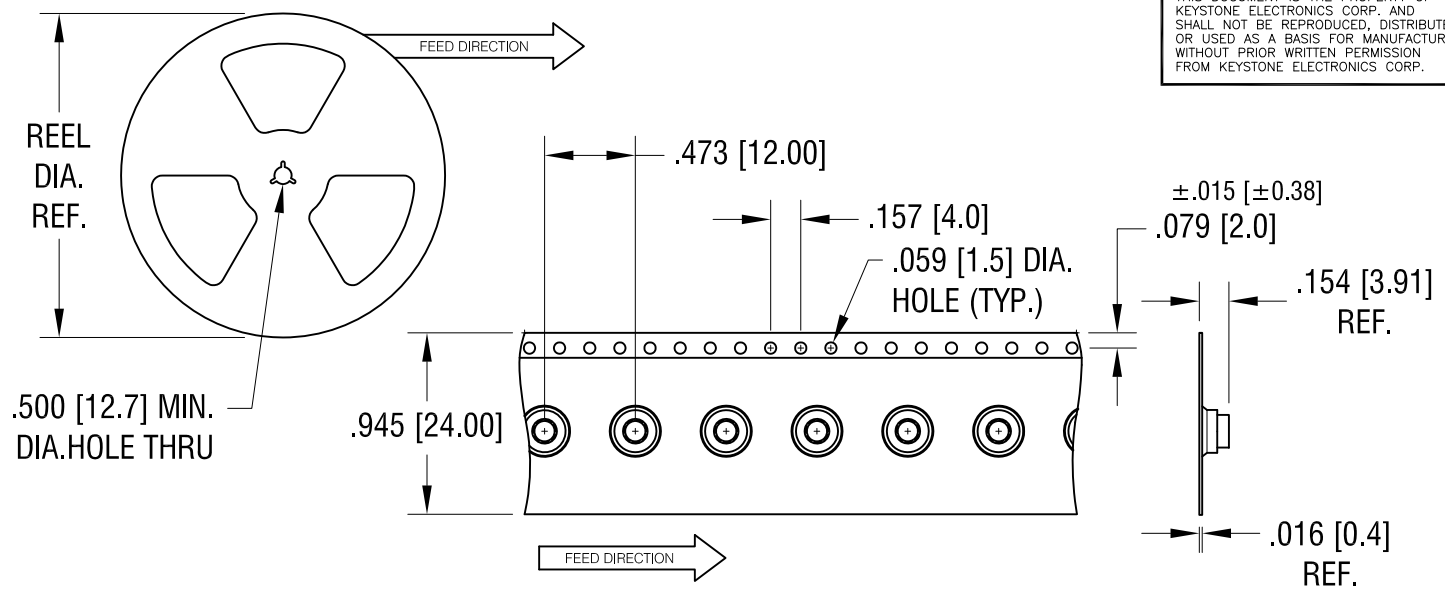

ACTUAL SIZE

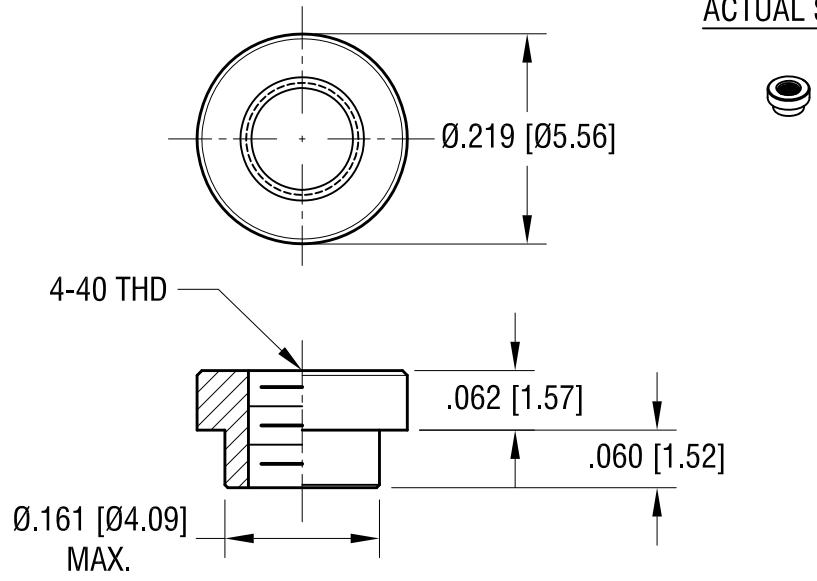

NOTES:

1. SUPPLIED ON TAPE AND REEL ONLY.
TAPE AND REEL SPECIFICATIONS:
2. TAPE:
MAT'L - ALL CONDUCTIVE POLYSTYRENE CARRIER
ANSI/EIA-481 STANDARD
3. REEL:
13" [330.2] DIA. 1500 PIECES PER REEL
4. KAPTON TAPE ADDED TO TOP SURFACE
OF STANDOFF

KEYSTONE ELECTRONICS CORP.			
www.keyelco.com • ASTORIA, N.Y. 11105-2017 • Tel (718) 956-8900			
PART NAME		SM STANDOFF	
MATERIAL		STEEL	
FINISH		DRN BY	DATE
ELECTRO-TIN		NT	4.11.16
		APP'D	SCALE
		LN	5X, 1X
TOLERANCES	INCH [MM]	CODE	DWG NO.
DECIMAL	± .005 [± 0.13]	C	4881
ANGULAR	± 1°		
UNLESS OTHERWISE SPECIFIED			

DATE	DESCRIPTION	REV.	
------	-------------	------	--