

THIS DRAWING IS UNPUBLISHED.

RELEASED FOR PUBLICATION

ALL RIGHTS RESERVED.

© COPYRIGHT - By -

LOC J

DIST -

REVISIONS

変更

DESCRIPTION

DATE

DWN

APVD

P

P

REVISED PER ECO-11-005140

28MAR11

RK

HMR

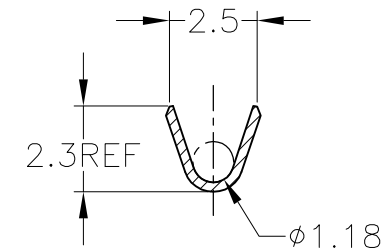
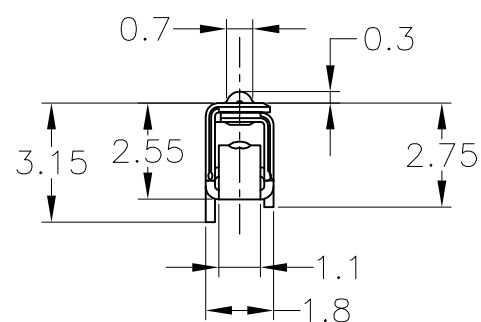
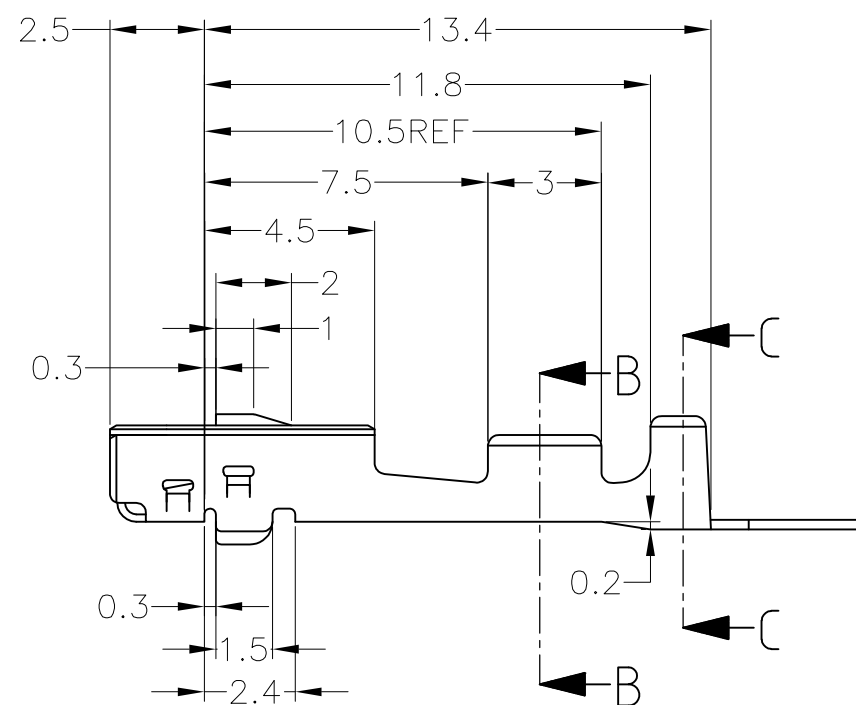
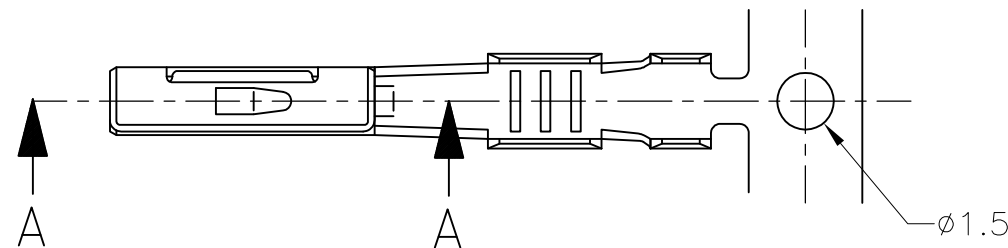

SECT. B-B

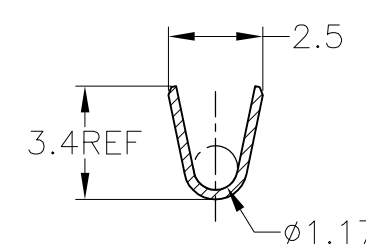

SECT. C-C

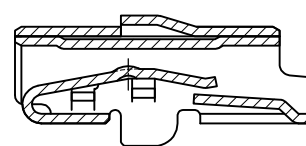

SECT. A-A

SIZE MARK

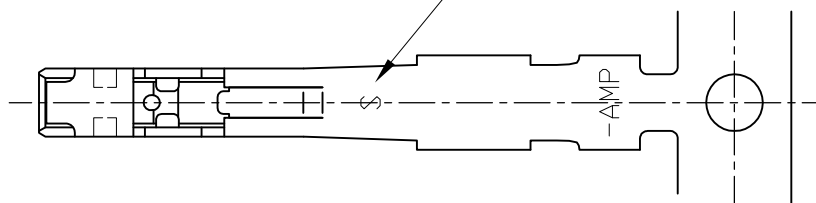

1. 適用電線 ; AVSS, CAVS, CAVUS 0.3~0.85mm²
 AVS 0.3~0.5mm²

但し、使用するコネクタによって
 適用電線が制限される場合がある

2. 取付適用規格番号 ; 114-5217

1. APPLICABLE WIRE RANGE;
 AVSS, CAVS, CAVUS 0.3~0.85mm²
 AVS 0.3~0.5mm²

BUT, AN APPLIED CONNECTOR OFTEN MAKE
 THE APPLICABLE WIRE RANGE NARROW

2. APPLICATION SPEC NO; 114-5217

SEE DRAWING 316836-2	316836-2
PRE-TIN	316836-1
FINISH	PART NUMBER

THIS DRAWING IS A CONTROLLED DOCUMENT.		DWN M.SUGAWARA 17MAY06	 TE Connectivity	
DIMENSIONS: 単位: 耗 mm		CHK T.SHINOHARA 17MAY06		
TOLERANCES UNLESS OTHERWISE SPECIFIED: 一般公差		APVD K.BETSUI 17MAY06	NAME 名称	
0 PLC ±- 1 PLC ±- 2 PLC ±- 3 PLC ±- 4 PLC ±- ANGLES ±-		PRODUCT SPEC 製品規格	040 III UNSEALED CONTACT RECEPTACLE (S) Sn	
MATERIAL 材料 Cu ALLOY		APPLICATION SPEC 取付適用規格 114-5217	SIZE A3	CAGE CODE 00779
FINISH 仕上 SEE TABLE		WEIGHT 0.27g	DRAWING NO 番号 C-316836	RESTRICTED TO -
TOLERANCES UNLESS OTHERWISE SPECIFIED: 一般公差		CUSTOMER DRAWING		SCALE 尺度 5:1
10 ≥ ±0.2	30 ≥ > 10 ±0.25	SHEET 1 OF 1		REV P
100 ≥ > 30 ±0.3	ANGLE: ±3°			