

MSRD620CT, NRVSRD620VCT, SSRD8620CT Series

Switch-mode Soft Ultrafast Recovery Reverse Polarity Power Rectifier

State-of-the-art geometry features epitaxial construction with glass passivation. Ideally suited for low voltage, high frequency switching power supplies, free wheeling diode and polarity protection diodes.

Features

- Soft Ultrafast Recovery
- Matched Dual Die Construction – May Be Paralleled for High Current Output
- Short Heat Sink Tab Manufactured – Not Sheared
- Epoxy Meets UL 94 V-0 @ 0.125 in.
- NRVSRD and SSRD8 Prefixes for Automotive and Other Applications Requiring Unique Site and Control Change Requirements; AEC-Q101 Qualified and PPAP Capable
- These Devices are Pb-Free and are RoHS Compliant*

Mechanical Characteristics

- Case: Epoxy, Molded
- Weight: 0.4 Grams (Approximately)
- Finish: All External Surfaces Corrosion Resistant and Terminal Leads are Readily Solderable
- Lead and Mounting Surface Temperature for Soldering Purposes: 260°C Max. for 10 Seconds
- ESD Ratings:
 - ◆ Machine Model = C
 - ◆ Human Body Model = 2



ON Semiconductor®

www.onsemi.com

SOFT ULTRAFAST REVERSE POLARITY RECTIFIER 6.0 AMPERES, 200 VOLTS

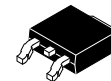

DPAK
CASE 369C

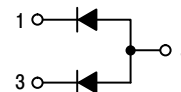

MARKING DIAGRAM

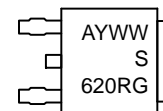

A = Assembly Location
Y = Year
WW = Work Week
G = Pb-Free Package

ORDERING INFORMATION

Device	Package	Shipping†
MSRD620CTRG	DPAK (Pb-Free)	75 Units/Rail
SSRD8620CTRG	DPAK (Pb-Free)	75 Units/Rail
MSRD620CTT4RG	DPAK (Pb-Free)	2,500 / Tape & Reel
NRVSRD620VCTT4RG	DPAK (Pb-Free)	2,500 / Tape & Reel
SSRD8620CTT4RG	DPAK (Pb-Free)	2,500 / Tape & Reel

†For information on tape and reel specifications, including part orientation and tape sizes, please refer to our Tape and Reel Packaging Specifications Brochure, BRD8011/D.

MSRD620CT, NRVSRD620VCT, SSRD8620CT Series

MAXIMUM RATINGS

Rating	Symbol	Value	Unit
Peak Repetitive Reverse Voltage Working Peak Reverse Voltage DC Blocking Voltage	V_{RRM} V_{RWM} V_R	200	V
Average Rectified Forward Current (At Rated V_R , $T_C = 162^\circ\text{C}$) Per Leg Per Package	I_O	3.0 6.0	A
Non-Repetitive Peak Surge Current (Surge Applied at Rated Load Conditions, Halfwave, Single Phase, 60 Hz) Per Package	I_{FSM}	45	A
Storage/Operating Case Temperature	T_{stg}, T_C	-65 to +175	$^\circ\text{C}$
Operating Junction Temperature	T_J	-65 to +175	$^\circ\text{C}$

Stresses exceeding those listed in the Maximum Ratings table may damage the device. If any of these limits are exceeded, device functionality should not be assumed, damage may occur and reliability may be affected.

THERMAL CHARACTERISTICS

Rating	Symbol	Value	Unit
Thermal Resistance – Junction-to-Case (Note 1) Per Leg	$R_{\theta JC}$	5.0	$^\circ\text{C}/\text{W}$
Thermal Resistance – Junction-to-Ambient (Note 1) Per Leg	$R_{\theta JA}$	60	$^\circ\text{C}/\text{W}$
Thermal Resistance – Junction-to-Ambient (Note 2) Per Leg	$R_{\theta JA}$	166	$^\circ\text{C}/\text{W}$

1. Mounted with 700 mm² copper pad size (approximately 1 in²) 1 oz FR4 board.
2. Mounted with pad size approximately 46 mm² copper, 1 oz FR4 board.

ELECTRICAL CHARACTERISTICS

Rating	Symbol	Value		Unit
Maximum Instantaneous Forward Voltage (Note 3) Per Leg ($I_F = 3.0\text{ A}$) ($I_F = 6.0\text{ A}$)	V_F	$T_J = 25^\circ\text{C}$	$T_J = 125^\circ\text{C}$	V
		1.15 1.30	0.95 1.15	
Maximum Instantaneous Reverse Current (Note 3) Per Leg ($V_R = 200\text{ V}$)	I_R	$T_J = 25^\circ\text{C}$	$T_J = 125^\circ\text{C}$	μA
		1.0	200	
Maximum Reverse Recovery Time (Note 4) Per Leg ($V_R = 30\text{ V}$, $I_F = 1.0\text{ A}$, $di/dt = 50\text{ A}/\mu\text{s}$)	t_{rr}	75		ns

Product parametric performance is indicated in the Electrical Characteristics for the listed test conditions, unless otherwise noted. Product performance may not be indicated by the Electrical Characteristics if operated under different conditions.

3. Pulse Test: Pulse Width $\leq 380\ \mu\text{s}$, Duty Cycle $\leq 2\%$.
4. t_{rr} measured projecting from 25% of I_{RM} to ground.

MSRD620CT, NRVSRD620VCT, SSRD8620CT Series

TYPICAL CHARACTERISTICS

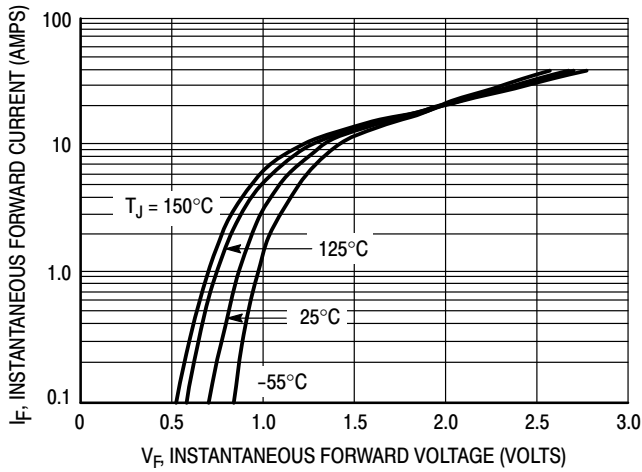

Figure 1. Typical Forward Voltage, Per Leg

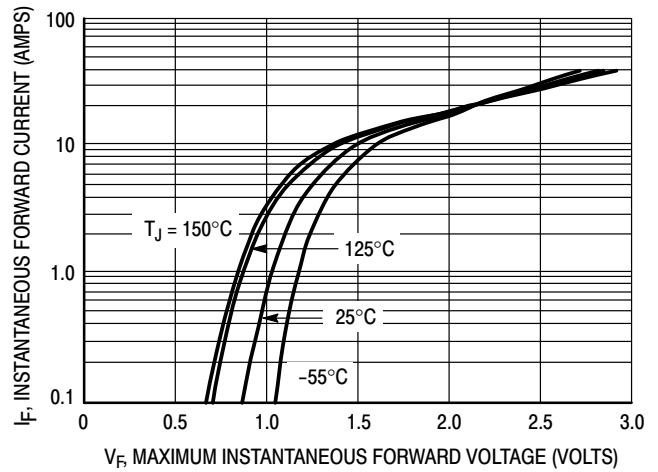

Figure 2. Maximum Forward Voltage, Per Leg

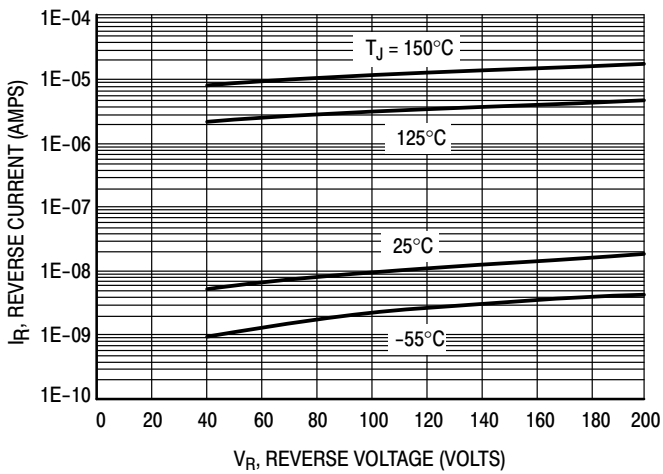

Figure 3. Typical Reverse Current, Per Leg

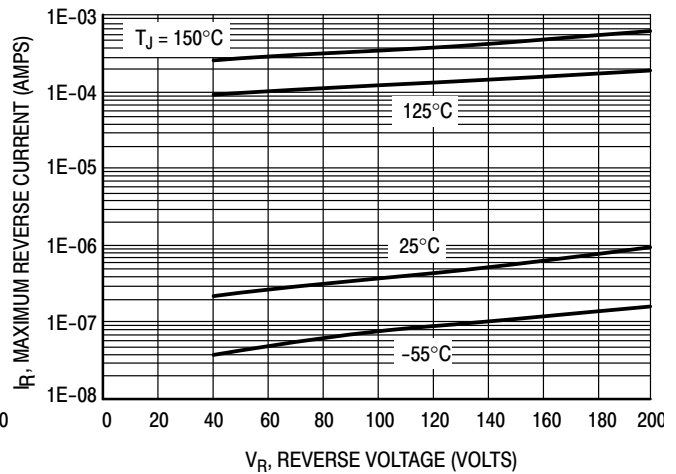

Figure 4. Maximum Reverse Current, Per Leg

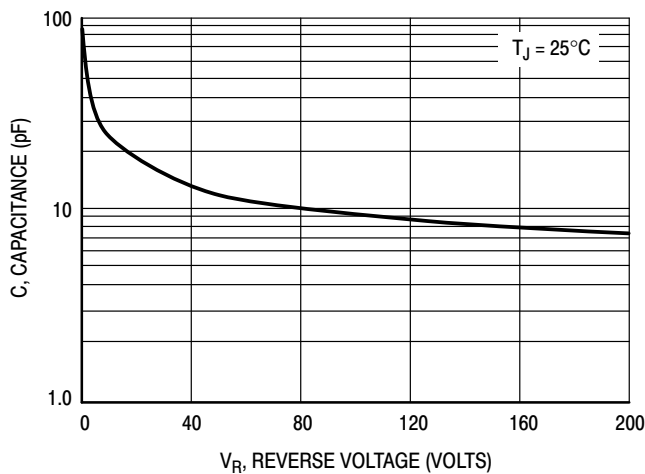

Figure 5. Typical Capacitance

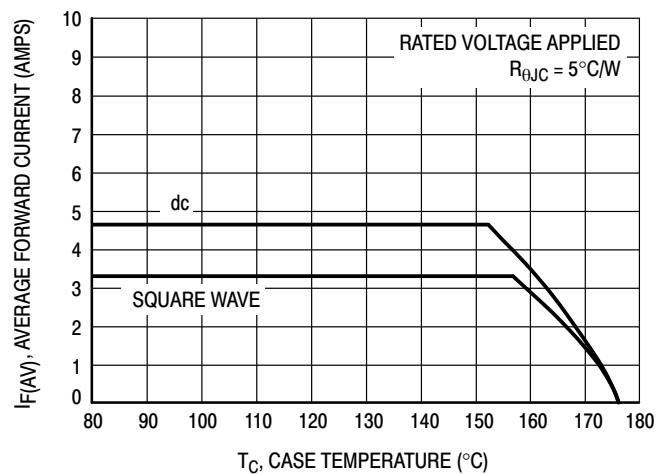

Figure 6. Typical Current Derating, Case (Per Leg)

MSRD620CT, NRVSRD620VCT, SSRD8620CT Series

TYPICAL CHARACTERISTICS

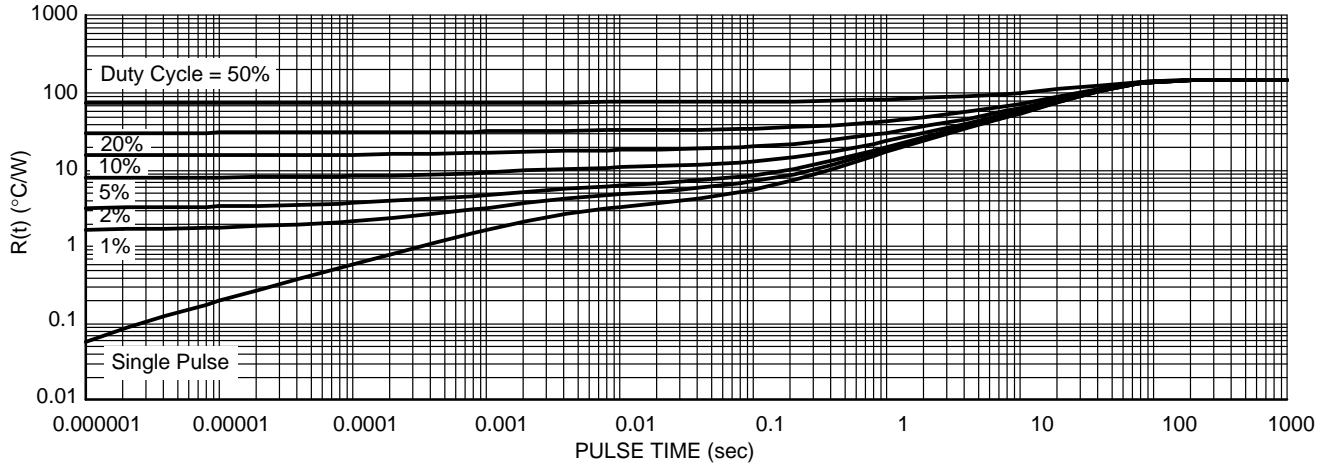

Figure 7. Thermal Response, Junction-to-Ambient (46 mm² pad)

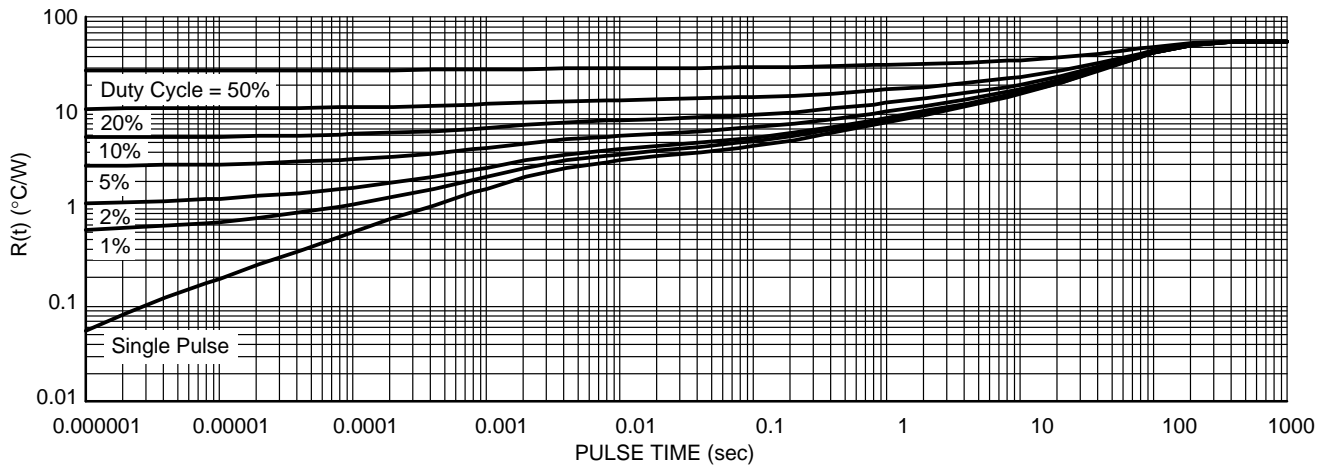
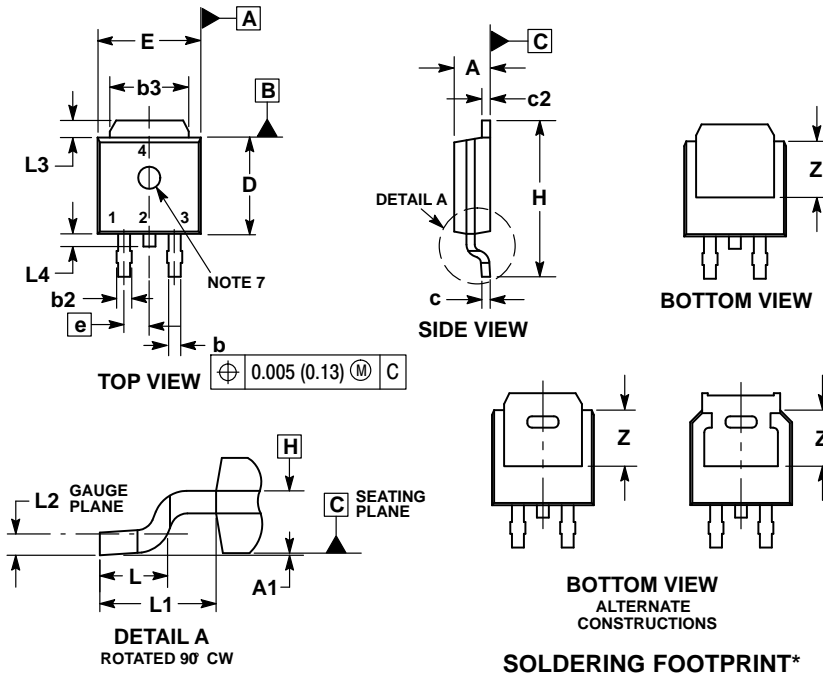

Figure 8. Thermal Response, Junction-to-Ambient (1 in² pad)

MSRD620CT, NRVSRD620VCT, SSRD8620CT Series

PACKAGE DIMENSIONS

DPAK (SINGLE GAUGE) CASE 369C ISSUE F



NOTES:

1. DIMENSIONING AND TOLERANCING PER ASME Y14.5M, 1994.
2. CONTROLLING DIMENSION: INCHES.
3. THERMAL PAD CONTOUR OPTIONAL WITHIN DIMENSIONS b3, L3 and Z.
4. DIMENSIONS D AND E DO NOT INCLUDE MOLD FLASH, PROTRUSIONS, OR BURRS. MOLD FLASH, PROTRUSIONS, OR GATE BURRS SHALL NOT EXCEED 0.006 INCHES PER SIDE.
5. DIMENSIONS D AND E ARE DETERMINED AT THE OUTERMOST EXTREMES OF THE PLASTIC BODY.
6. DATUMS A AND B ARE DETERMINED AT DATUM PLANE H.
7. OPTIONAL MOLD FEATURE.

DIM	INCHES		MILLIMETERS	
	MIN	MAX	MIN	MAX
A	0.086	0.094	2.18	2.38
A1	0.000	0.005	0.00	0.13
b	0.025	0.035	0.63	0.89
b2	0.028	0.045	0.72	1.14
b3	0.180	0.215	4.57	5.46
c	0.018	0.024	0.46	0.61
c2	0.018	0.024	0.46	0.61
D	0.235	0.245	5.97	6.22
E	0.250	0.265	6.35	6.73
e	0.090 BSC		2.29 BSC	
H	0.370	0.410	9.40	10.41
L	0.055	0.070	1.40	1.78
L1	0.114 REF		2.90 REF	
L2	0.020 BSC		0.51 BSC	
L3	0.035	0.050	0.89	1.27
L4	---	0.040	---	1.01
Z	0.155	---	3.93	---

SCALE 3:1 $\left(\frac{\text{mm}}{\text{inches}}\right)$

*For additional information on our Pb-Free strategy and soldering details, please download the ON Semiconductor Soldering and Mounting Techniques Reference Manual, SOLDERRM/D.

ON Semiconductor and are trademarks of Semiconductor Components Industries, LLC dba ON Semiconductor or its subsidiaries in the United States and/or other countries. ON Semiconductor owns the rights to a number of patents, trademarks, copyrights, trade secrets, and other intellectual property. A listing of ON Semiconductor's product/patent coverage may be accessed at www.onsemi.com/site/pdf/Patent-Marking.pdf. ON Semiconductor reserves the right to make changes without further notice to any products herein. ON Semiconductor makes no warranty, representation or guarantee regarding the suitability of its products for any particular purpose, nor does ON Semiconductor assume any liability arising out of the application or use of any product or circuit, and specifically disclaims any and all liability, including without limitation special, consequential or incidental damages. Buyer is responsible for its products and applications using ON Semiconductor products, including compliance with all laws, regulations and safety requirements or standards, regardless of any support or applications information provided by ON Semiconductor. "Typical" parameters which may be provided in ON Semiconductor data sheets and/or specifications can and do vary in different applications and actual performance may vary over time. All operating parameters, including "Typicals" must be validated for each customer application by customer's technical experts. ON Semiconductor does not convey any license under its patent rights nor the rights of others. ON Semiconductor products are not designed, intended, or authorized for use as a critical component in life support systems or any FDA Class 3 medical devices or medical devices with a same or similar classification in a foreign jurisdiction or any devices intended for implantation in the human body. Should Buyer purchase or use ON Semiconductor products for any such unintended or unauthorized application, Buyer shall indemnify and hold ON Semiconductor and its officers, employees, subsidiaries, affiliates, and distributors harmless against all claims, costs, damages, and expenses, and reasonable attorney fees arising out of, directly or indirectly, any claim of personal injury or death associated with such unintended or unauthorized use, even if such claim alleges that ON Semiconductor was negligent regarding the design or manufacture of the part. ON Semiconductor is an Equal Opportunity/Affirmative Action Employer. This literature is subject to all applicable copyright laws and is not for resale in any manner.

PUBLICATION ORDERING INFORMATION

LITERATURE FULFILLMENT:

Literature Distribution Center for ON Semiconductor
19521 E. 32nd Pkwy, Aurora, Colorado 80011 USA
Phone: 303-675-2175 or 800-344-3860 Toll Free USA/Canada
Fax: 303-675-2176 or 800-344-3867 Toll Free USA/Canada
Email: orderlit@onsemi.com

N. American Technical Support: 800-282-9855 Toll Free
USA/Canada
Europe, Middle East and Africa Technical Support:
Phone: 421 33 790 2910
Japan Customer Focus Center
Phone: 81-3-5817-1050

ON Semiconductor Website: www.onsemi.com

Order Literature: <http://www.onsemi.com/orderlit>

For additional information, please contact your local Sales Representative