

Split Dual Si/SiC Hybrid IGBT Module 100 Amperes/1200 Volts

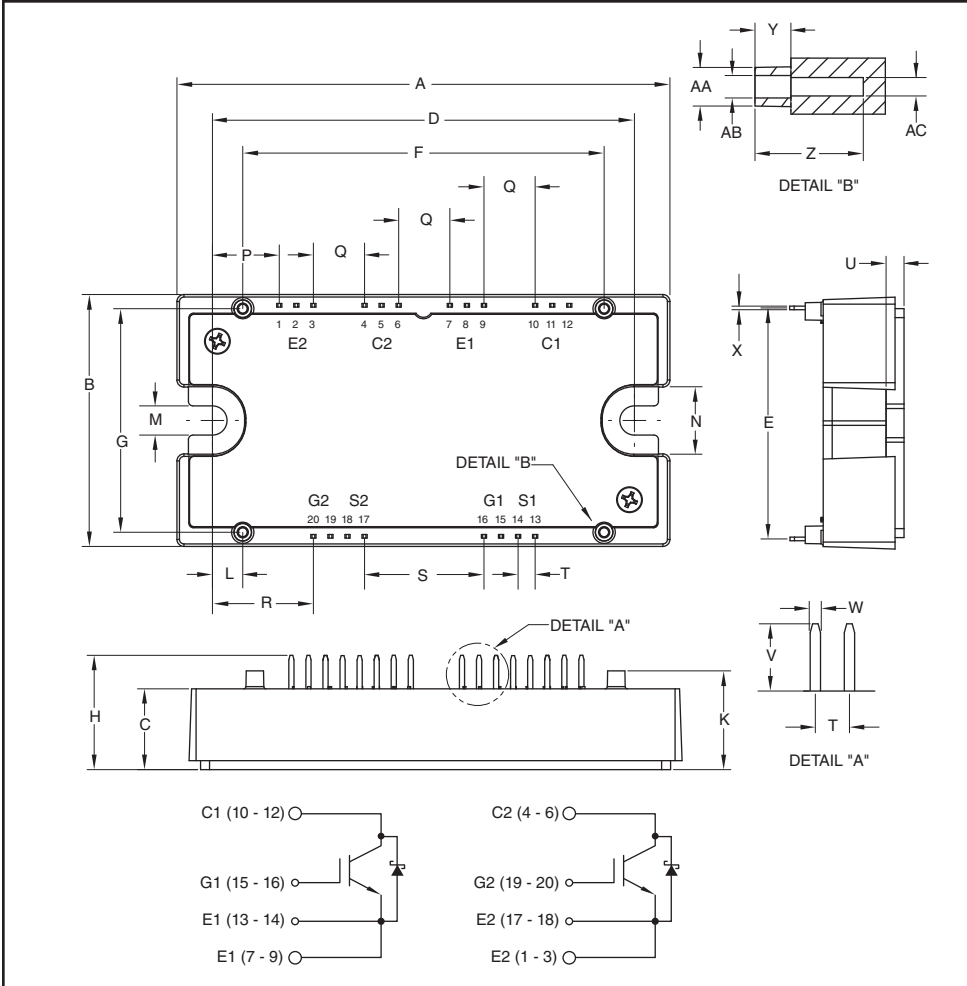

Outline Drawing and Circuit Diagram

Dimensions	Inches	Millimeters
A	4.32	109.8
B	2.21	56.1
C	0.71	18.0
D	3.70±0.02	94.0±0.5
E	2.026	51.46
F	3.17	80.5
G	1.96	49.8
H	1.00	25.5
K	0.87	22.0
L	0.266	6.75
M	0.26	6.5
N	0.59	15.0
P	0.586	14.89

Dimensions	Inches	Millimeters
Q	0.449	11.40
R	0.885	22.49
S	1.047	26.6
T	0.15	3.80
U	0.16	4.0
V	0.30	7.5
W	0.045	1.15
X	0.03	0.8
Y	0.16	4.0
Z	0.47	12.1
AA	0.17 Dia.	4.3 Dia.
AB	0.10 Dia.	2.5 Dia.
AC	0.08 Dia.	2.1 Dia.

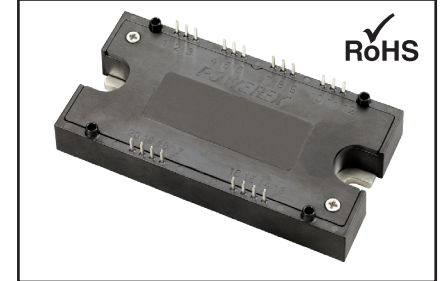

Description:

Powerex IGBT Modules are designed for use in high frequency applications; upwards of 30 kHz for hard switching applications and 80 kHz for soft switching applications. Each module consists of two IGBT Transistors with each transistor having a reverse-connected super-fast recovery free-wheel silicon carbide Schottky diode. All components and interconnects are isolated from the heat sinking baseplate, offering simplified system assembly and thermal management.

Features:

- Low ESW(off)
- Aluminum Nitride Isolation
- Discrete Super-Fast Recovery Free-Wheel Silicon Carbide Schottky Diode**
- Low Internal Inductance
- 2 Individual Switches per Module
- Isolated Baseplate for Easy Heat Sinking
- Copper Baseplate
- RoHS Compliant

Applications:

- Energy Saving Power Systems such as:
Fans; Pumps; Consumer Appliances
- High Frequency Type Power Systems such as:
UPS; High Speed Motor Drives; Induction Heating; Welder; Robotics
- High Temperature Power Systems such as:
Power Electronics in Electric Vehicle and Aviation Systems

QID1210005
Split Dual Si/SiC Hybrid IGBT Module
 100 Amperes/1200 Volts

Absolute Maximum Ratings, $T_j = 25^\circ\text{C}$ unless otherwise specified

Ratings	Symbol	QID1210005	Units
Junction Temperature	T_j	-40 to 150	$^\circ\text{C}$
Storage Temperature	T_{stg}	-40 to 150	$^\circ\text{C}$
Collector-Emitter Voltage (G-E Short)	V_{CES}	1200	Volts
Gate-Emitter Voltage (C-E Short)	V_{GES}	± 20	Volts
Collector Current ($T_C = 25^\circ\text{C}$)	I_C	100*	Amperes
Peak Collector Current	I_{CM}	200*	Amperes
Emitter Current** ($T_C = 25^\circ\text{C}$)	I_E	80*	Amperes
Repetitive Peak Emitter Current ($T_C = 25^\circ\text{C}$, $t_p = 10\text{ms}$, Half Sine Pulse)**	I_{EM}	455*	Amperes
Maximum Collector Dissipation ($T_C = 25^\circ\text{C}$, $T_j \leq 150^\circ\text{C}$)	P_C	730	Watts
Mounting Torque, M6 Mounting	—	40	in-lb
Weight	—	270	Grams
Isolation Voltage (Main Terminal to Baseplate, AC 1 min.)	V_{ISO}	2500	Volts

IGBT Electrical Characteristics, $T_j = 25^\circ\text{C}$ unless otherwise specified

Characteristics	Symbol	Test Conditions	Min.	Typ.	Max.	Units	
Collector-Cutoff Current	I_{CES}	$V_{CE} = V_{CES}$, $V_{GE} = 0\text{V}$	—	—	1.0	mA	
Gate Leakage Current	I_{GES}	$V_{GE} = V_{GES}$, $V_{CE} = 0\text{V}$	—	—	0.5	μA	
Gate-Emitter Threshold Voltage	$V_{GE(th)}$	$I_C = 10\text{mA}$, $V_{CE} = 10\text{V}$	4.5	6.0	7.5	Volts	
Collector-Emitter Saturation Voltage	$V_{CE(sat)}$	$I_C = 100\text{A}$, $V_{GE} = 15\text{V}$, $T_j = 25^\circ\text{C}$	—	5.0	6.5	Volts	
		$I_C = 100\text{A}$, $V_{GE} = 15\text{V}$, $T_j = 125^\circ\text{C}$	—	5.0	—	Volts	
Total Gate Charge	Q_G	$V_{CC} = 600\text{V}$, $I_C = 100\text{A}$, $V_{GE} = 15\text{V}$	—	450	—	nC	
Input Capacitance	C_{ies}		—	—	16	nf	
Output Capacitance	C_{oes}	$V_{CE} = 10\text{V}$, $V_{GE} = 0\text{V}$	—	—	1.3	nf	
Reverse Transfer Capacitance	C_{res}		—	—	0.3	nf	
Inductive Load	Turn-on Delay Time	$t_{d(on)}$	$V_{CC} = 600\text{V}$, $I_C = 100\text{A}$,	—	—	TBD	ns
	Rise Time			t_r	$V_{GE1} = V_{GE2} = 15\text{V}$,	—	—
Switch	Turn-off Delay Time	$t_{d(off)}$	$R_G = 3.1\Omega$,	—	—	TBD	ns
	TimeFall Time			t_f	Inductive Load Switching Operation	—	—

* Pulse width and repetition rate should be such that device junction temperature (T_j) does not exceed $T_{j(max)}$ rating.

**Represents characteristics of the anti-parallel, emitter-to-collector silicon carbide Schottky diode (FWDI).

QID1210005
Split Dual Si/SiC Hybrid IGBT Module
 100 Amperes/1200 Volts

Reverse Schottky Diode Characteristics, $T_j = 25\text{ }^\circ\text{C}$ unless otherwise specified

Characteristics	Symbol	Test Conditions	Min.	Typ.	Max.	Units
Diode Forward Voltage	V_{FM}	$I_F = 80\text{A}, V_{GS} = -5\text{V}$	—	1.6	2.0	Volts
		$I_F = 80\text{A}, V_{GS} = -5\text{V}, T_j = 175^\circ\text{C}$	—	2.5	3.2	Volts
Diode Reverse Current	I_R	$V_R = 1200\text{V}$	—	140	800	μA
		$V_R = 1200, T_j = 150^\circ\text{C}$	—	260	1600	μA
Diode Capacitive Charge	Q_C	$V_R = 1200\text{V}, I_F = 80\text{A}, di/dt = 800\text{A}/\mu\text{s}$	—	520	—	nC

Thermal and Mechanical Characteristics, $T_j = 25\text{ }^\circ\text{C}$ unless otherwise specified

Characteristics	Symbol	Test Conditions	Min.	Typ.	Max.	Units
Thermal Resistance, Junction to Case	$R_{th(j-c)Q}$	Per IGBT 1/2 Module,	—	—	0.17	$^\circ\text{C}/\text{W}$
		T_C Reference Point Under Chips				
Thermal Resistance, Junction to Case	$R_{th(j-c)D}$	Per FWDi 1/2 Module, T_C Reference	—	—	0.304	$^\circ\text{C}/\text{W}$
		T_C Reference Point Under Chips				
Contact Thermal Resistance	$R_{th(c-f)}$	Per 1/2 Module, Thermal Grease Applied	—	0.04	—	$^\circ\text{C}/\text{W}$
External Gate Resistance	R_G		3.1	—	31	Ω
Internal Inductance	L_{int}	IGBT Part	—	10	—	nH

QID1210005
Split Dual Si/SiC Hybrid IGBT Module
 100 Amperes/1200 Volts

OUTPUT CHARACTERISTICS (TYPICAL)

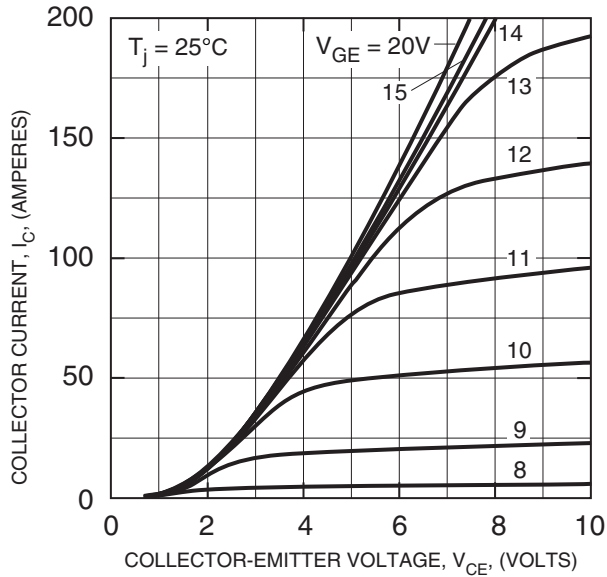

TRANSFER CHARACTERISTICS (TYPICAL)

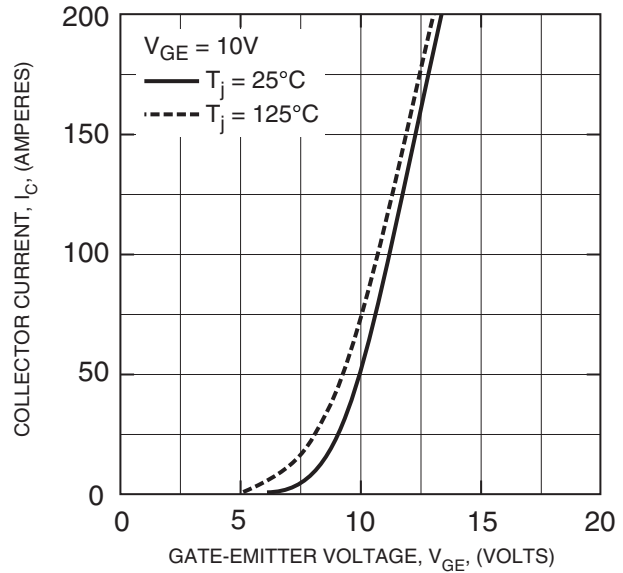

COLLECTOR-EMITTER SATURATION VOLTAGE CHARACTERISTICS (TYPICAL)

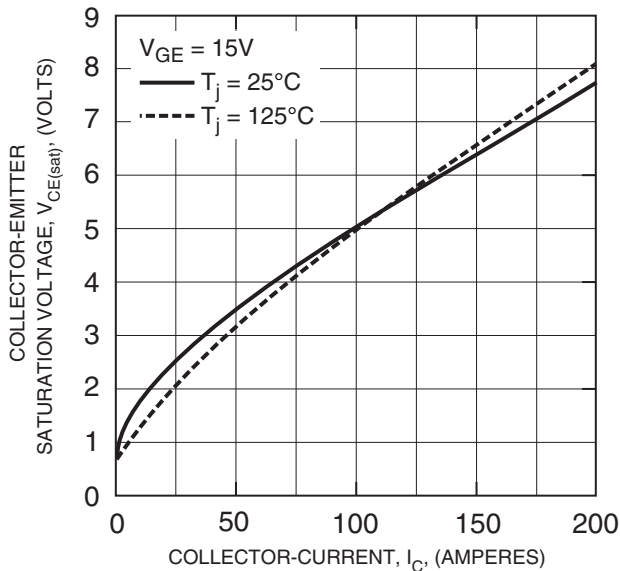

COLLECTOR-EMITTER SATURATION VOLTAGE CHARACTERISTICS (TYPICAL)

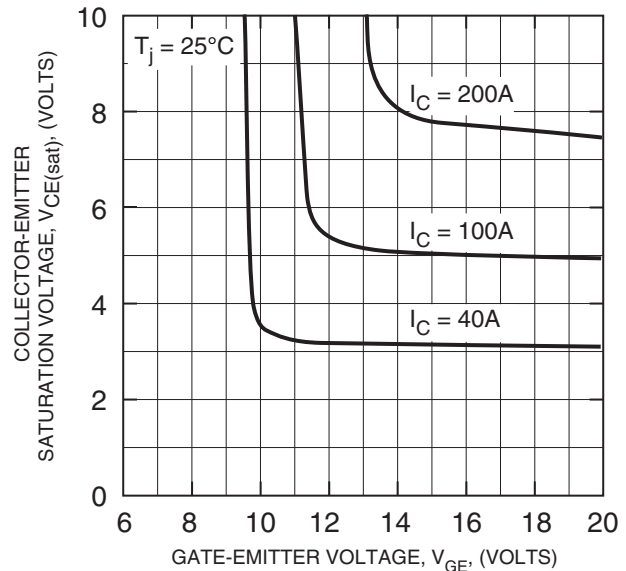

QID1210005
Split Dual Si/SiC Hybrid IGBT Module
 100 Amperes/1200 Volts

FREE-WHEEL SCHOTTKY DIODE FORWARD CHARACTERISTICS (TYPICAL)

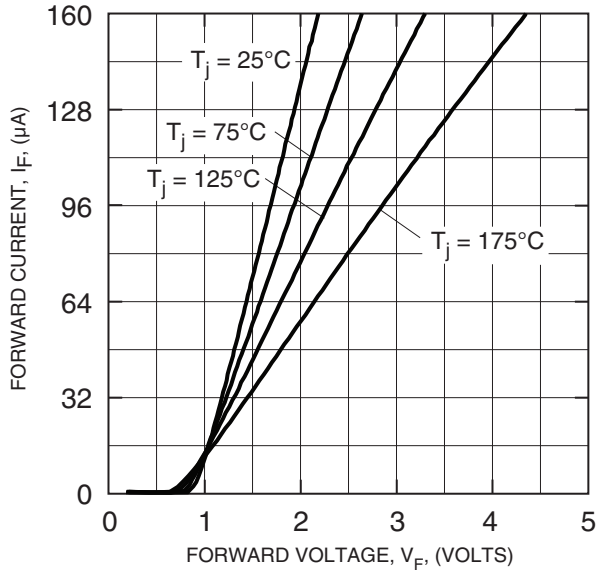

FREE-WHEEL SCHOTTKY DIODE REVERSE CHARACTERISTICS (TYPICAL)

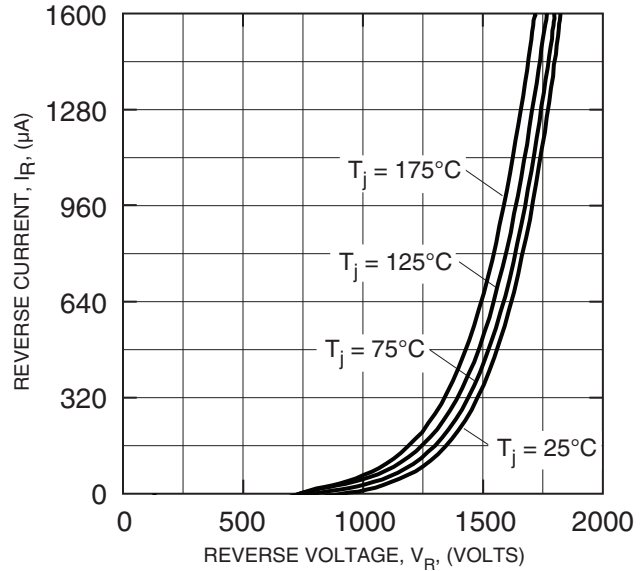

CAPACITANCE VS. V_{CE} (TYPICAL)

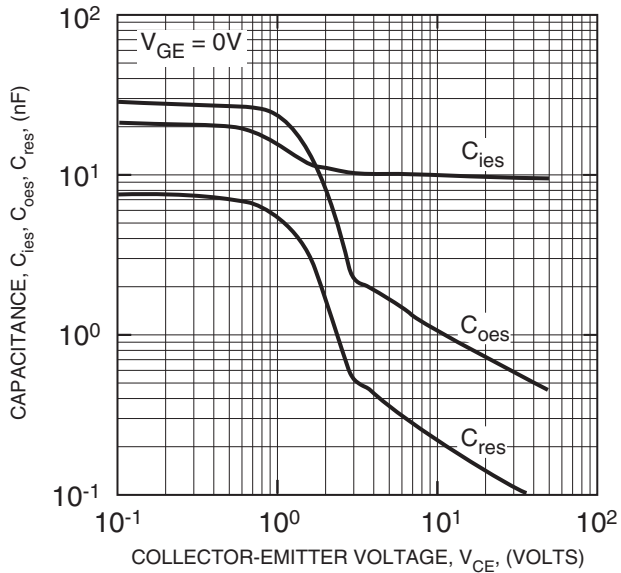

HALF-BRIDGE SWITCHING CHARACTERISTICS (TYPICAL)

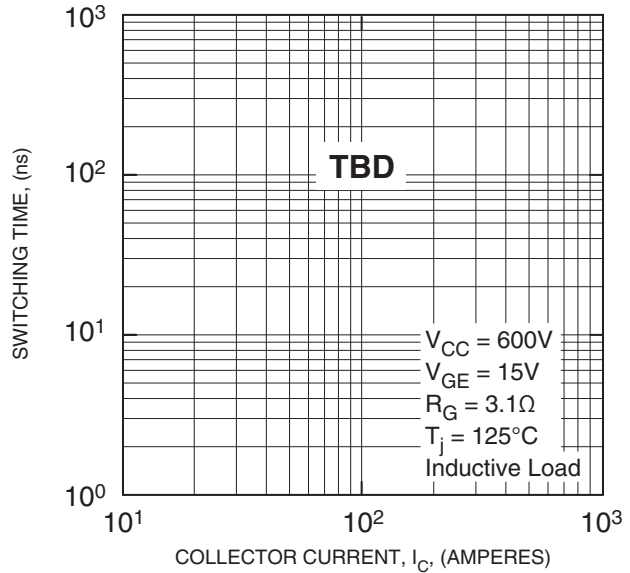

Information presented is based upon manufacturers testing and projected capabilities. This information is subject to change without notice. The manufacturer makes no claim as to the suitability of use, reliability, capability, or future availability of this product.

QID1210005
Split Dual Si/SiC Hybrid IGBT Module
 100 Amperes/1200 Volts

GATE CHARGE VS. V_{GE}

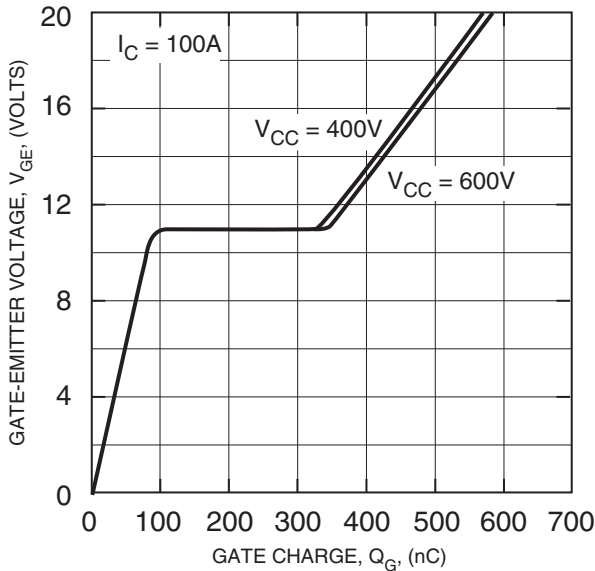

SWITCHING LOSS VS. COLLECTOR CURRENT (TYPICAL)

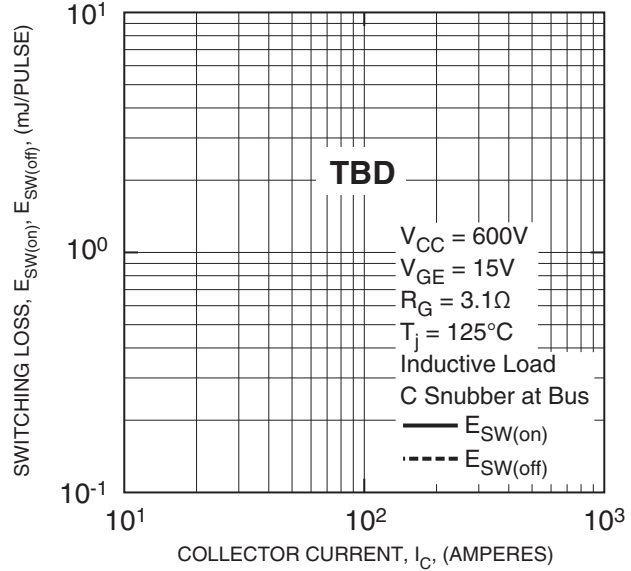

SWITCHING LOSS VS. GATE RESISTANCE (TYPICAL)

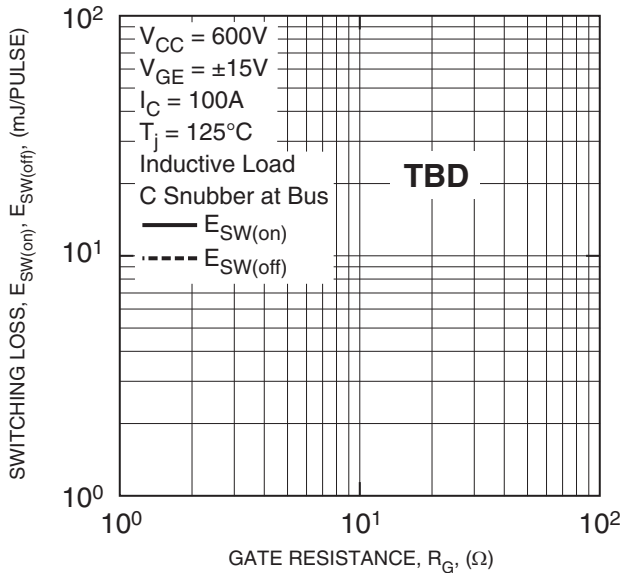

REVERSE RECOVERY SWITCHING LOSS VS. EMITTER CURRENT (TYPICAL)

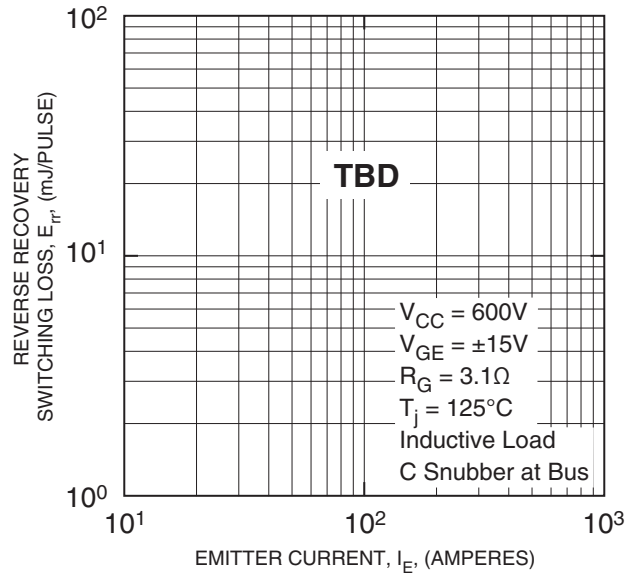

Information presented is based upon manufacturers testing and projected capabilities. This information is subject to change without notice. The manufacturer makes no claim as to the suitability of use, reliability, capability, or future availability of this product.

QID1210005
Split Dual Si/SiC Hybrid IGBT Module
 100 Amperes/1200 Volts

REVERSE RECOVERY SWITCHING LOSS VS. GATE RESISTANCE (TYPICAL)

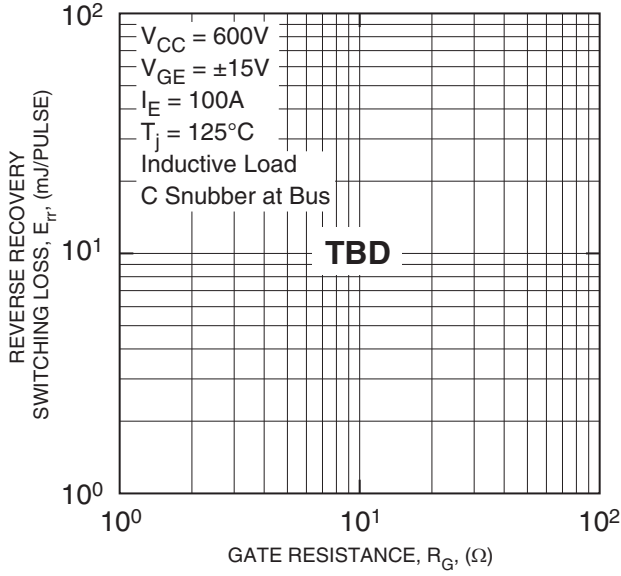

TRANSIENT THERMAL IMPEDANCE CHARACTERISTICS (IGBT & FWDi)

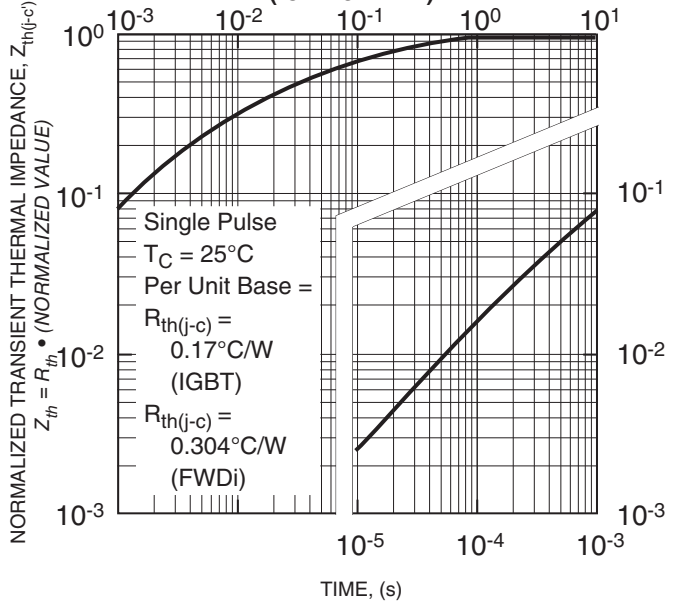

Information presented is based upon manufacturers testing and projected capabilities. This information is subject to change without notice. The manufacturer makes no claim as to the suitability of use, reliability, capability, or future availability of this product.