

NCP1653EVB

300 W, Wide Mains, PFC Stage Driven by the NCP1653 Evaluation Board User's Manual



ON Semiconductor®

<http://onsemi.com>

Eval Board User's Manual

Introduction

The NCP1653 is a Power Factor Controller to efficiently drive Continuous Conduction Mode (CCM) step-up pre-converters. As shown by the ON Semiconductor application note AND8184/D, that details the four key steps to design a NCP1653 driven PFC stage, this circuit represents a major leap towards compactness and ease of implementation.

Housed in a DIP8 or SO-8 package, the circuit minimizes the external components count without sacrificing performance and flexibility. In particular, the NCP1653 integrates all the key protections to build robust PFC stages like an effective input power runaway clamping circuitry.

When needed or wished, the NCP1653 also allows operation in Follower Boost mode* to drastically lower the pre-converter size and cost, in a straight-forward manner. For more information on this device, please refer to the ON Semiconductor data sheet NCP1653/D.

The board illustrates the circuit capability to effectively drive a high power, universal line application. More specifically, it is designed to meet the following specifications:

- Maximum output power: 300 W
- Input voltage range: from 90 V_{rms} to 265 V_{rms}
- Regulation output voltage: 385 V
- Switching frequency: 100 kHz

This application was tested using a resistive load. As in many applications, the PFC controller is fed by an output of the downstream converter, there is generally no need for an auto-supply circuitry. Hence, in our demo-board, the NCP1653 V_{CC} is to be supplied by a 15 V external power supply.

The external voltage source that is to be applied to the NCP1653 V_{CC}, should exceed 13.25 V typically, to allow the circuit startup. After startup, the V_{CC} operating range is from 9.5 to 18 V.

The voltage applied to the NCP1653 V_{CC} must NOT exceed 18 V.

The NCP1653 is a continuous conduction mode and fixed frequency controller (100 kHz). The coil (600 μH) is selected to limit the peak-to-peak current ripple in the range of 30% at the sinusoid top, in full load and low line conditions. Again, for details on how the application is designed, please refer to the ON Semiconductor application note AND8184/D.

As detailed in the document, the board yields very nice Power Factor ratios and effectively limits the Total Harmonic Distortion (THD).

*The "Follower Boost" mode makes the pre-converter output voltage stabilize at a level that varies linearly versus the AC line amplitude. This technique aims at reducing the difference between the output and input voltages to optimize the boost efficiency and minimize the cost of the PFC stage (refer to MC33260 and NCP1653 data sheet at www.onsemi.com).

NCP1653EVB



Figure 1. The Board

Three coils from three different vendors have been validated on this board:

- C1062-B from CoilCraft
- MB09008 from microSpire
- SRW42EC-E02H001 from TDK

For the sake of consistency, this evaluation board reports the performance and results that were obtained using the CoilCraft coil. However, it has been checked that the two other coils yield high performance too.

NCP1653EVB

PCB LAYOUT

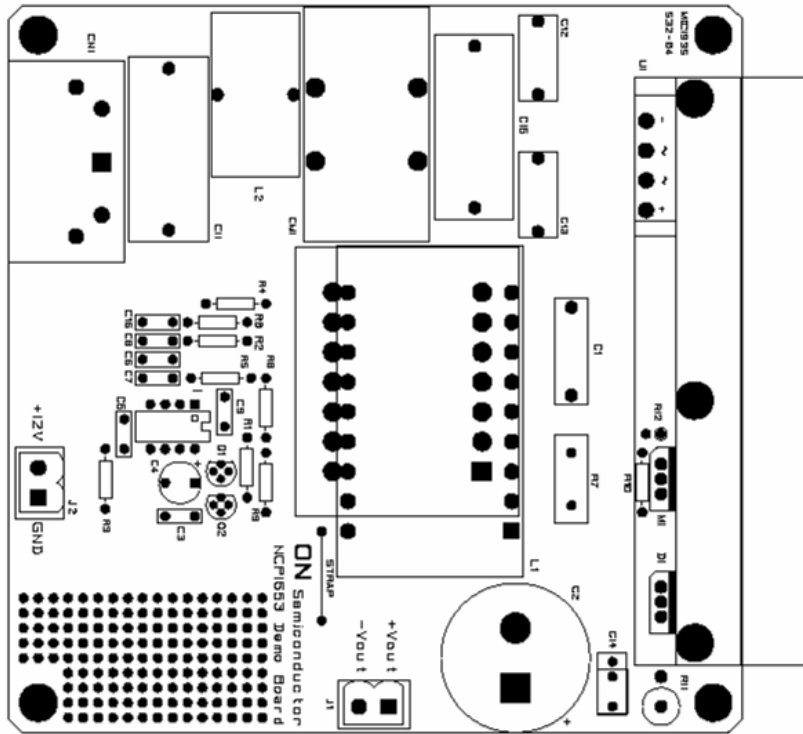

Figure 3. Component Placement

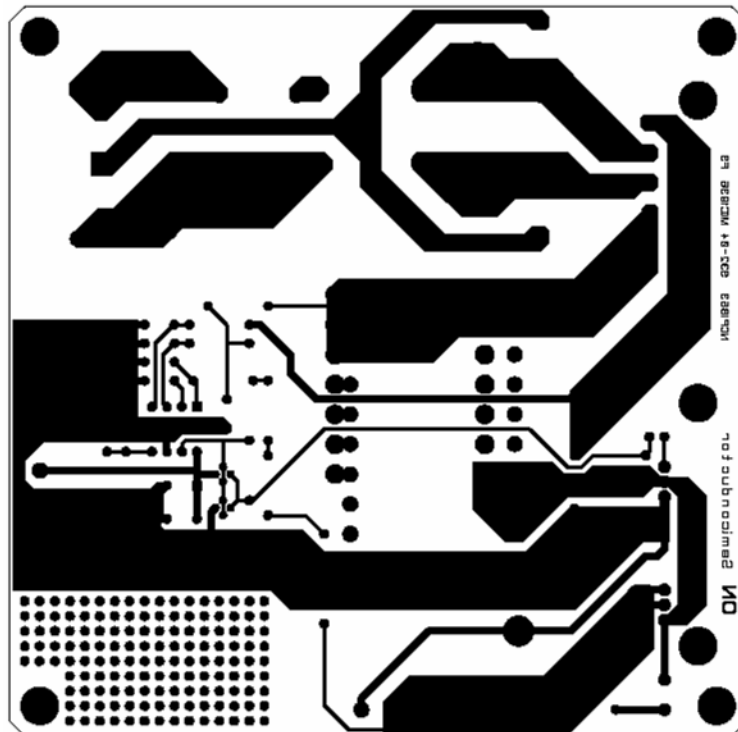

Figure 4. PCB Layout (Components' Side)

NCP1653EVB

GENERAL BEHAVIOR – TYPICAL WAVEFORMS

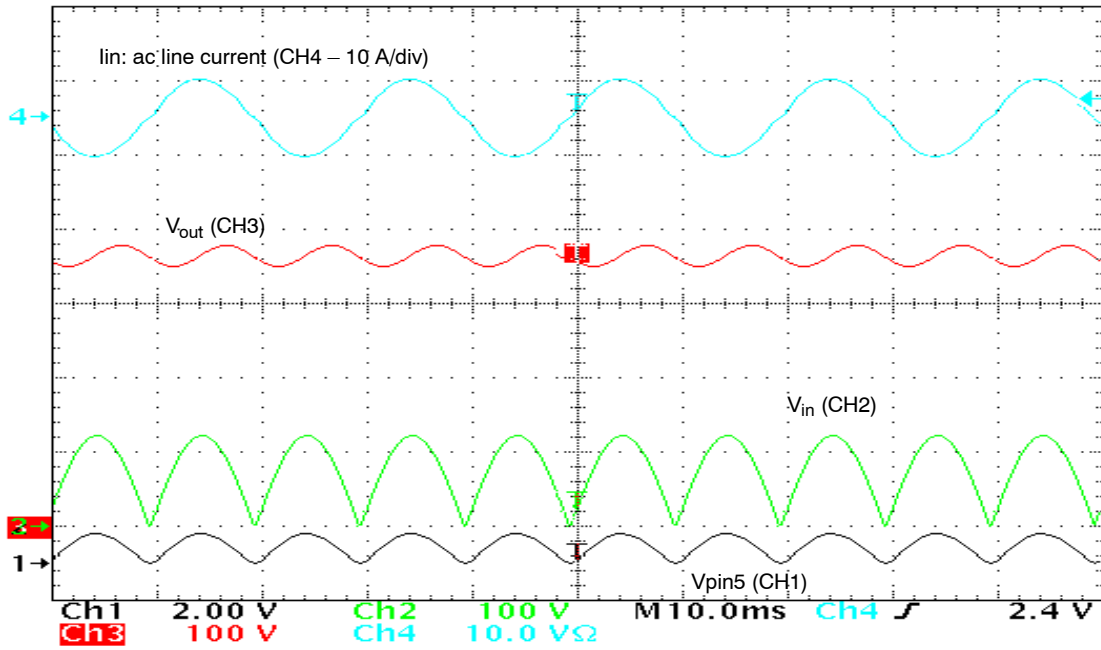

Figure 5.

$V_{ac} = 90\text{ V}$, $P_{in} = 326.5\text{ W}$, $V_{out} = 365\text{ V}$, $I_{out} = 822\text{ mA}$, $PF = 0.999$, $THD = 4\%$

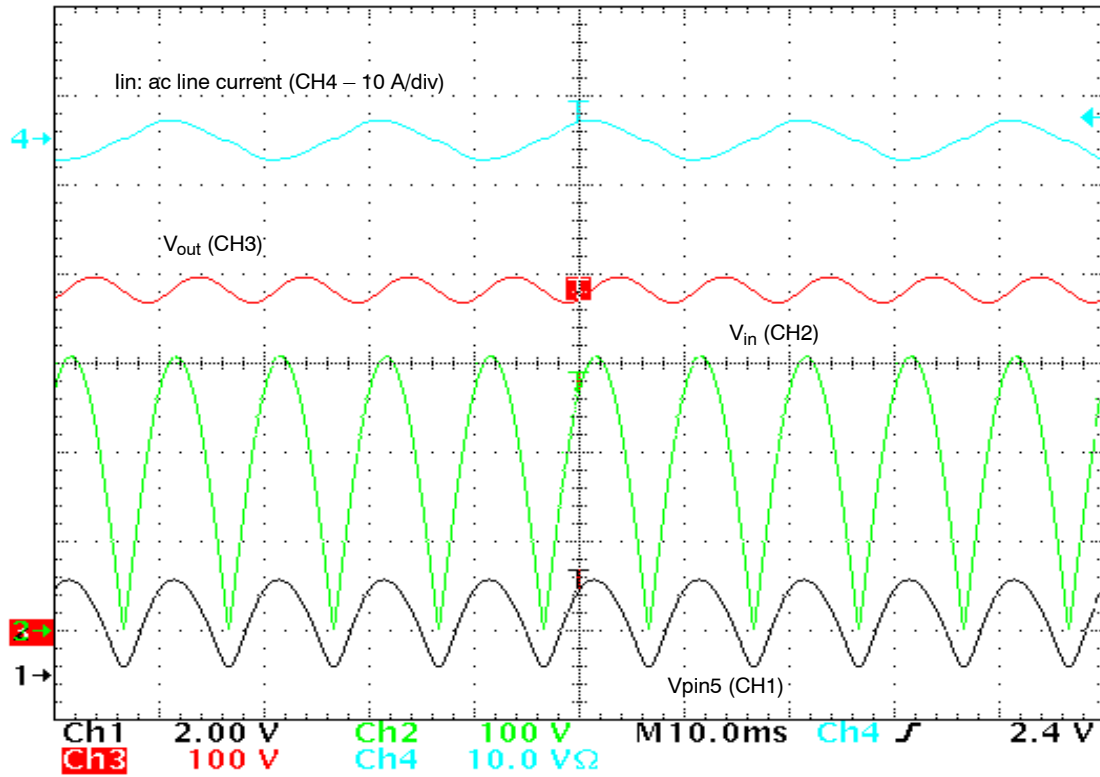

Figure 6.

$V_{ac} = 220\text{ V}$, $P_{in} = 325\text{ W}$, $V_{out} = 384\text{ V}$, $I_{out} = 814\text{ mA}$, $PF = 0.989$, $THD = 8\%$

NCP1653EVB

Table 1. THD AND EFFICIENCY AT $V_{ac} = 110\text{ V}$

P_{in} (W)	V_{out} (V)	I_{out} (A)	PF (-)	THD (%)	eff (%)
331.3	370.0	0.83	0.998	4	93
296.7	373.4	0.74	0.998	4	93
157.3	381.8	0.38	0.995	7	92
109.8	383.5	0.26	0.993	9	91
80.7	384.4	0.19	0.990	10	91
67.4	385.0	0.16	0.988	10	91

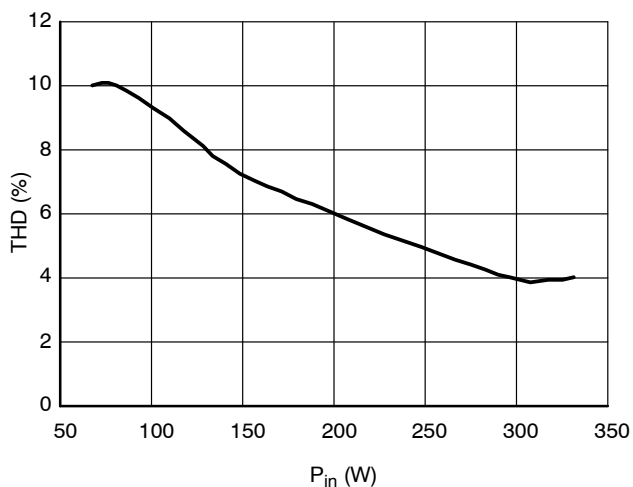

Figure 7. THD vs. P_{in}

The Total Harmonic Distortion keeps below 10% from P_{max} (maximum power – 300 W) down to about $P_{max}/5$.

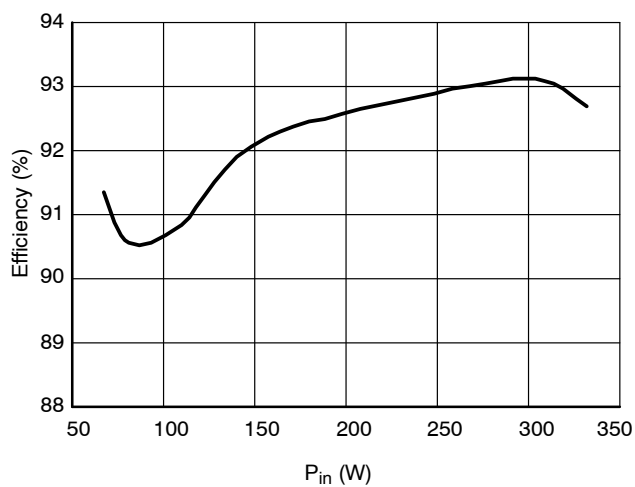

Figure 8. Efficiency vs. P_{in}

The efficiency remains higher than 90% for input powers ranging from 67 to 330 W.

In standby (no load conditions), the PFC stage enters a stable burst mode, where the circuit keeps regulating the output voltage and minimizes the power consumption (See Figure 11).

NCP1653EVB

Table 2. THD AND EFFICIENCY AT $V_{ac} = 220\text{ V}$

P_{in} (W)	V_{out} (V)	I_{out} (A)	PF (-)	THD (%)	eff (%)
66.9	386.6	0.16	0.920	15	92
80.2	386.5	0.19	0.933	14	92
110.0	386.7	0.27	0.960	11	95
157.3	386.4	0.38	0.978	9	93
215.7	386.2	0.53	0.985	8	95
311.4	385.4	0.77	0.989	9	95

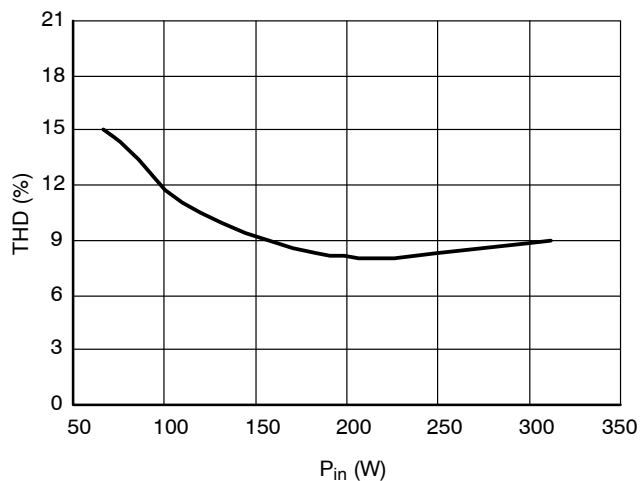

Figure 9. THD vs. P_{in}

Similarly to the 110 Vac results, low THD values are obtained. The Total Harmonic Distortion keeps below 15% from P_{max} (maximum power – 300 W) down to about $P_{max}/5$.

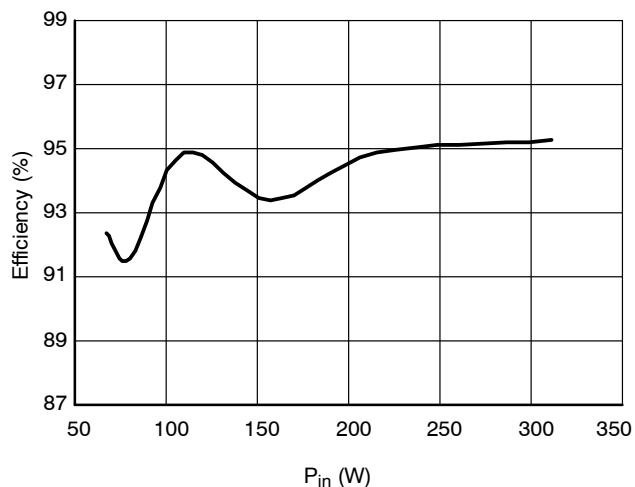

Figure 10. Efficiency vs. P_{in}

Again the efficiency keeps high in a large power range. More specifically, it remains higher than 91% for input powers ranging from 67 to 330 W.

In standby (no load conditions), the PFC stage enters a stable burst mode, where the circuit keeps regulating the output voltage and minimizes the power consumption.

NCP1653EVB

Thermal Measurements

The following results were obtained using a thermal camera, after a 1 h operation at 25°C ambient temperature. These data are indicative. They show that *the demo-board may require additional heatsink capability* if used in high ambient temperature applications.

Measurements Conditions:

- $V_{ac} = 90\text{ V}$
- $P_{in} = 326\text{ W}$
- $V_{out} = 365\text{ V}$
- $I_{out} = 0.82\text{ A}$
- $PF = 0.999$
- $THD = 3\%$

Power MOSFET	Heatsink	Bulk Capacitor	Output Diode	Coil (ferrite)	Coil (wires)	Input Bridge
100°C	80°C	50°C	75°C	100°C	130°C	85°C

No Load Operation

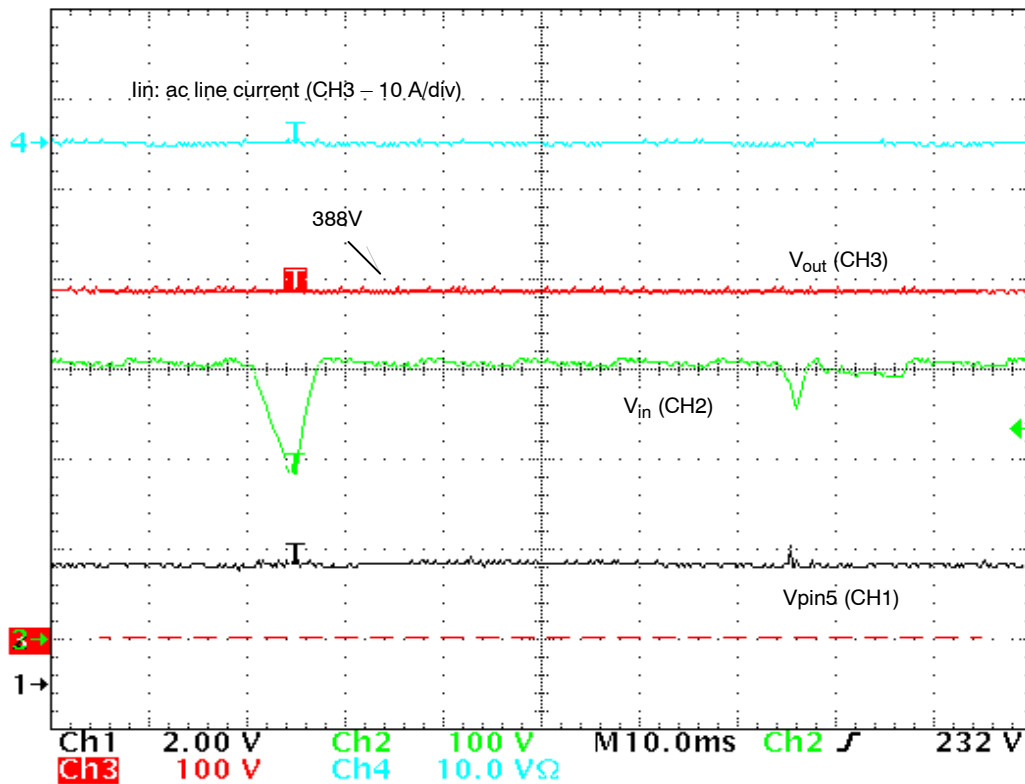

Figure 11.

$P_{out} = 0\text{ W}$, $V_{ac} = 230\text{ V}$

When in light load, the circuit enters a welcome burst mode that enables the circuit to keep regulating. V_{pin5} oscillates around the pin5 internal reference voltage (2.5 V).

The power losses @ 220 V_{ac} , are nearly 130 mW. This result was obtained by using a W.h meter (measure duration: 1 h).

NCP1653EVB

Soft-Start

The NCP1653 grounds the “ V_{control} ” capacitor when it is off, i.e., before each circuit active sequence (“ V_{control} ” being the regulation block output). Provided the low regulation

bandwidth required by PFC stages, “ V_{control} ” increases slowly. As a result, **the power delivery rises gradually** and the PFC pre-regulator startup smoothly and noiselessly.

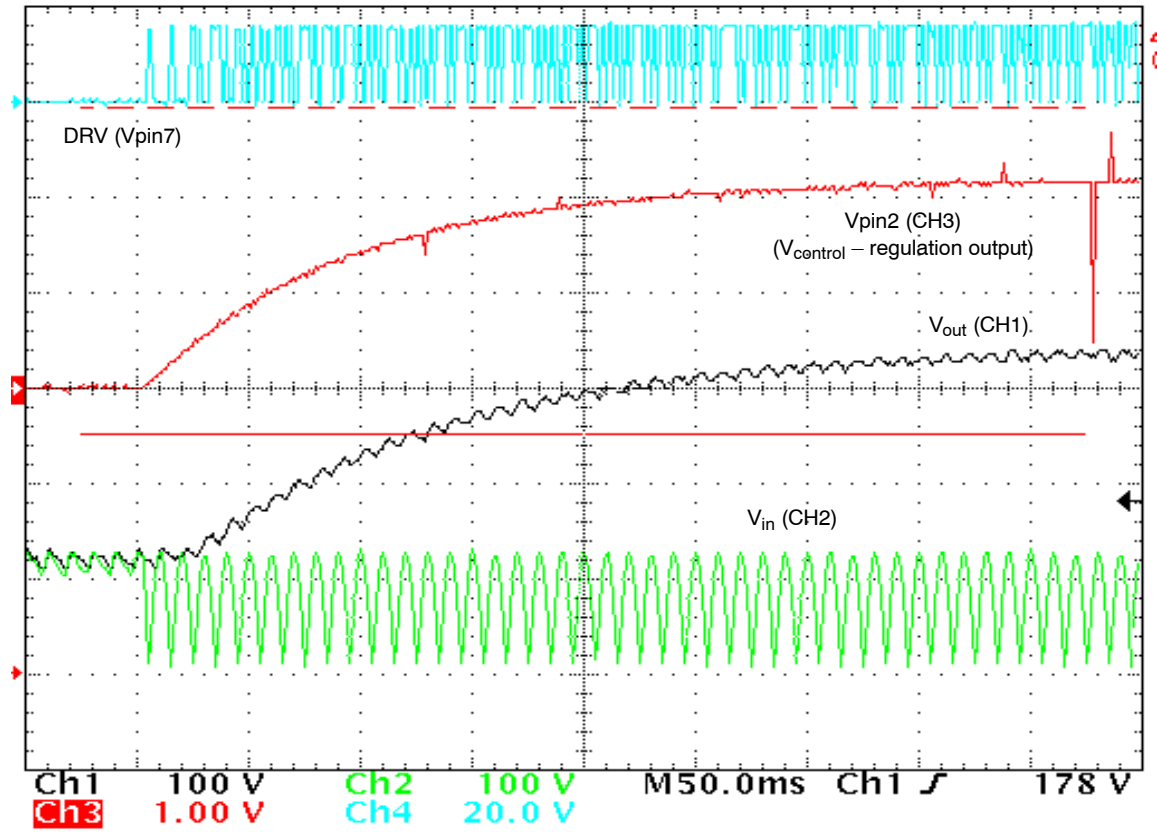

Figure 12.

NCP1653EVB

Test Procedure

1. Apply a 500 Ω /400 W resistive load across the output (between the “+V_{OUT}” and “-V_{OUT}” terminals of the board).
2. Adjust a 350 W or more, isolated ac power source so that it outputs a 110 V_{RMS}, sinusoidal voltage (50 or 60 Hz).
3. Place a power analyzer able to measure:
 - The power delivered by the power source (“Pin”)
 - The power factor (“PF”) and the Total Harmonic Distortion (“THD”) of the current absorbed from the ac power source
4. Plug the application to the ac power source.
5. Supply the controller by applying 15 V to the V_{CC} socket (between the “+12 V” and “GND” terminals of the board) and measure:

Parameters	Comments	Limits
V _{OUT}	Voltage Measured between “+V _{OUT} ” and “-V _{OUT} ”	365 V < V _{OUT} < 385 V
PF	Power Factor	> 0.990
THD	Total Harmonic Distortion	< 8%
Efficiency		> 91%

6. Observe the input current (current drawn from the ac power source) using a current probe and the oscilloscope. The current is nearly sinusoidal.

7. Gradually decrease the power source input voltage until the input current top becomes flat. Measure the plateau (see Figure 14). It must be between 4.9 and 5.3 A (over-current limitation). This test must be very short to avoid any excessive heating of the board. Immediately stop the test if the input current exceeds 5.3 A, or if the input voltage is below 75 V_{RMS}.
8. Increase the ac power source voltage to 220 V and measure:

Parameters	Comments	Limits
V _{OUT}	Voltage Measured between “+V _{OUT} ” and “-V _{OUT} ”	375 V < V _{OUT} < 395 V
PF	Power Factor	> 0.980
THD	Total Harmonic Distortion	< 12%
Efficiency		> 93%

9. Observe the output voltage (i.e., the voltage between the “+V_{OUT}” and “-V_{OUT}” terminals of the board) with an oscilloscope. Unplug the PFC stage from the power source. Set the triggering level at about 200 V, the trigger position being set at 10% of the screen. Program the scope to observe 50 or 100 ms in single acquisition mode.
10. Abruptly apply the power source. Check that the output voltage keeps below 450 V (Over-Voltage Protection) (see Figure 15).

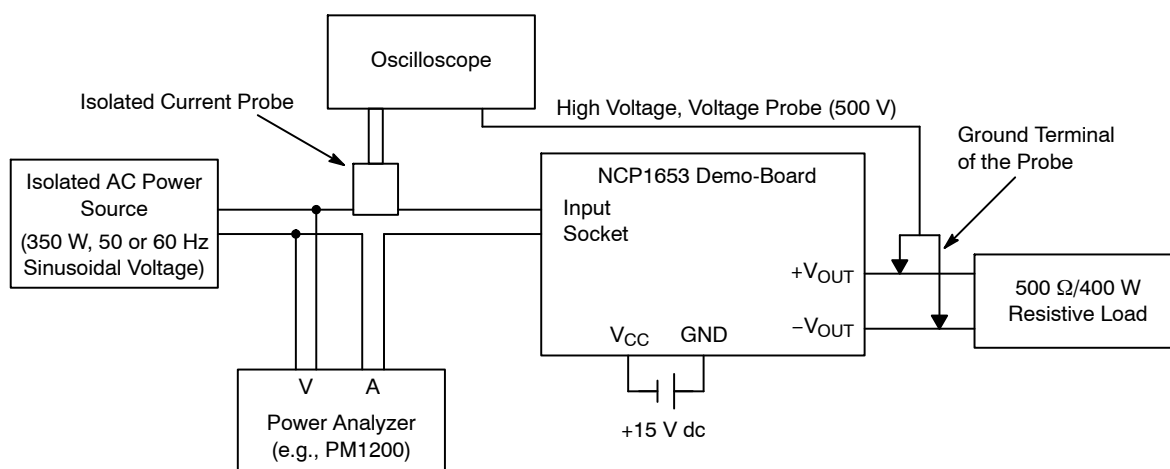

WARNING: The board contains high voltage, hot, live parts. Be very cautious when manipulating or testing it. It is the responsibility of those who utilize the board, to take all the precautions to avoid that themselves or other people are injured by electric hazards or are victim of any other pains caused by the board.

Figure 13. Test Procedure Schematic

NCP1653EVB

Table 3. BILL OF MATERIALS FOR THE NCP1653 EVALUATION BOARD

Designator	Qty.	Description	Value	Tolerance	Footprint	Manufacturer	Manufacturer Part Number	Substitution Allowed	Lead Free
U2	1	Power Factor Controller	-	-	DIP8	ON Semiconductor	NCP1653PG	No	Yes
C1	1	Class X2 Capacitor	100 nF, 275 V	20%	Axial	Evov Rifa	PHE840MX6100M	No	Yes
C2	1	Electrolytic Capacitor	100 μ F, 450 V	20%	Radial	Vishay BC Components	2222 159 37101	No	Yes
C3, C7, C9	3	Polyester Film Capacitor	100 nF, 100 V	10%	Axial	AVX	BQ014E0104K	Yes	Yes
C4	1	Electrolytic Capacitor	47 μ F, 35 V	20%	Radial	Panasonic	ECA1VM470	Yes	Yes
C5, C6, C8	3	Polyester Film Capacitor	1 nF, 100 V	10%	Axial	AVX	BQ014E0102K	Yes	Yes
C11, C15	2	Class X2 Capacitor	1 μ F, 275 V	20%	Axial	Evov Rifa	PHE840MD7100M	No	Yes
C12, C13	2	Class Y2 Capacitor	4.7 nF, 250 V	20%	Disc	Vishay Roederstein	WYO472MCMCF0KR	Yes	Yes
R1	1	Axial Resistor	4.5 Ω , 1/4 W	1%	Axial	Panasonic	ERO-S2PHF4R53	Yes	Yes
R2	1	Axial Resistor	470 k Ω , 1/4 W	1%	Axial	Vishay Dale	CCF55470KFKE36	Yes	Yes
R3	1	Axial Resistor	56 k Ω , 1/4 W	1%	Axial	Vishay Dale	CCF5556K0KFKE36	Yes	Yes
R4	1	Axial Resistor	4.7 M Ω , 1/4 W	1%	Axial	Phoenix Passive Comp.	2306 242 64705	Yes	Yes
R5, R8	2	Axial Resistor	680 k Ω , 1/4 W	1%	Axial	Vishay Dale	CCF55680KFKE36	Yes	Yes
R6	1	Axial Resistor	2.8 k Ω , 1/4 W	1%	Axial	Vishay Dale	CCF552K80KFKE36	Yes	Yes
R7	1	Axial Resistor	0.1 Ω , 1/4 W	1%	Axial	Vishay Sfernice	RLP3 0R10 1%	No	Yes
R9	1	Axial Resistor	560 k Ω , 1/4 W	1%	Axial	Vishay Dale	CCF55560KFKE36	Yes	Yes
R10	1	Axial Resistor	10 k Ω , 1/4 W	1%	Axial	Vishay Dale	CCF5510K0KFKE36	Yes	Yes
R12	1	Strap (Short Circuit)	-	-	Through	-	-	Yes	Yes
L1	1	PFC Coil	600 μ H	-	-	Coilcraft	C1062-B	No	Yes
L4	1	DM Filter	150 μ H, 5 A	20%	Toroidal	Würth Elektronik	7447055	No	Yes
CM1	1	CM Filter	2x6.8 mH, 4 A	30%	-	Epcos	B82725J2402N20	No	Yes
U1	1	Bridge Rectifier	6 A, 800 V	-	KBU	Vishay General Semi.	KBU6K	No	Yes
D1	1	Diode	600 V, 4 A	-	TO220	Cree	CSD04060A	No	Yes
M1	1	MOSFET	600 V, 20 A	-	TO220	Infineon	SPP20N60S5	No	Yes
H1	1	Heatsink	2.9°C/W	-	-	Aavid Thermalloy	KM100-1	Yes	Yes
	4	Board Supports	-	-	-	Richco	TCBS-8-01	Yes	Yes
F1	1	Fuse	250 V, 4 A	-	-	Schurter	FTT 0034.5049	Yes	Yes
	2	Thermal Pad (TO220)	-	-	-	Bergquist	3223-07FR-43	Yes	Yes
	1	Heatsink Clip (TO218)	-	-	-	Aavid Thermalloy	4473	Yes	Yes
	2	Heatsink Clip (TO220)	-	-	-	Aavid Thermalloy	4426	Yes	Yes
CN1	1	AC Connector	-	-	-	Schurter	GSF1.1201.31	Yes	Yes
J1, GND	2	Terminal Block	-	-	Pitch: 5mm	Weidmuller	1715250000	Yes	Yes
	3	Screws	-	-	-	-	MPMS 003 0008 PH	-	-
STRAP	1	Strap (Short Circuit)	-	-	-	3M	923345-06-C	Yes	Yes

NCP1653EVB

Table 4. VENDORS CONTACTS

Vendor	Contact	Product Information
CoilCraft	-	www.coilcraft.com
microSpire	-	www.microspire.com
TDK	Info@tdk.de	www.tdk.co.jp/tetop01/
EPCOS	-	www.epcos.fr/
CREE	www.cree.com/Products/pwr_sales2.asp	www.cree.com/Products/pwr_index.asp

ON Semiconductor and  are registered trademarks of Semiconductor Components Industries, LLC (SCILLC). SCILLC owns the rights to a number of patents, trademarks, copyrights, trade secrets, and other intellectual property. A listing of SCILLC's product/patent coverage may be accessed at www.onsemi.com/site/pdf/Patent-Marking.pdf. SCILLC reserves the right to make changes without further notice to any products herein. SCILLC makes no warranty, representation or guarantee regarding the suitability of its products for any particular purpose, nor does SCILLC assume any liability arising out of the application or use of any product or circuit, and specifically disclaims any and all liability, including without limitation special, consequential or incidental damages. "Typical" parameters which may be provided in SCILLC data sheets and/or specifications can and do vary in different applications and actual performance may vary over time. All operating parameters, including "Typicals" must be validated for each customer application by customer's technical experts. SCILLC does not convey any license under its patent rights nor the rights of others. SCILLC products are not designed, intended, or authorized for use as components in systems intended for surgical implant into the body, or other applications intended to support or sustain life, or for any other application in which the failure of the SCILLC product could create a situation where personal injury or death may occur. Should Buyer purchase or use SCILLC products for any such unintended or unauthorized application, Buyer shall indemnify and hold SCILLC and its officers, employees, subsidiaries, affiliates, and distributors harmless against all claims, costs, damages, and expenses, and reasonable attorney fees arising out of, directly or indirectly, any claim of personal injury or death associated with such unintended or unauthorized use, even if such claim alleges that SCILLC was negligent regarding the design or manufacture of the part. SCILLC is an Equal Opportunity/Affirmative Action Employer. This literature is subject to all applicable copyright laws and is not for resale in any manner.

PUBLICATION ORDERING INFORMATION

LITERATURE FULFILLMENT:

Literature Distribution Center for ON Semiconductor
P.O. Box 5163, Denver, Colorado 80217 USA
Phone: 303-675-2175 or 800-344-3860 Toll Free USA/Canada
Fax: 303-675-2176 or 800-344-3867 Toll Free USA/Canada
Email: orderlit@onsemi.com

N. American Technical Support: 800-282-9855 Toll Free
USA/Canada
Europe, Middle East and Africa Technical Support:
Phone: 421 33 790 2910
Japan Customer Focus Center
Phone: 81-3-5817-1050

ON Semiconductor Website: www.onsemi.com

Order Literature: <http://www.onsemi.com/orderlit>

For additional information, please contact your local Sales Representative