

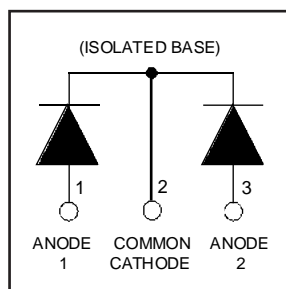
# HFA60MC60C

HEXFRED™

Ultrafast, Soft Recovery Diode

## Features

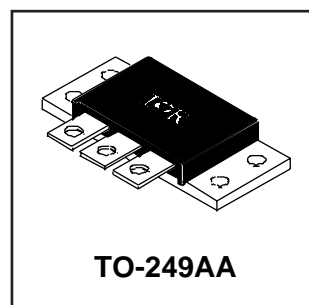
- Reduced RFI and EMI
- Reduced Snubbing
- Extensive Characterization of Recovery Parameters



$V_R = 600V$
$V_F(\text{typ.})^{\textcircled{3}} = 1.1V$
$I_{F(AV)} = 60A$
$Q_{rr}(\text{typ.}) = 200nC$
$I_{RRM}(\text{typ.}) = 6A$
$t_{rr}(\text{typ.}) = 30ns$
$di_{(rec)}/dt(\text{typ.})^{\textcircled{3}} = 170A/\mu s$

## Description

HEXFRED™ diodes are optimized to reduce losses and EMI/RFI in high frequency power conditioning systems. An extensive characterization of the recovery behavior for different values of current, temperature and di/dt simplifies the calculations of losses in the operating conditions. The softness of the recovery eliminates the need for a snubber in most applications. These devices are ideally suited for power converters, motors drives and other applications where switching losses are significant portion of the total losses.



## Absolute Maximum Ratings (per Leg)

	Parameter	Max.	Units
$V_R$	Cathode-to-Anode Voltage	600	V
$I_F @ T_C = 25^\circ C$	Continuous Forward Current	50	A
$I_F @ T_C = 100^\circ C$	Continuous Forward Current	24	
$I_{FSM}$	Single Pulse Forward Current ①	200	
$E_{AS}$	Non-Repetitive Avalanche Energy ②	220	μJ
$P_D @ T_C = 25^\circ C$	Maximum Power Dissipation	125	W
$P_D @ T_C = 100^\circ C$	Maximum Power Dissipation	50	
$T_J$ $T_{STG}$	Operating Junction and Storage Temperature Range	-55 to +150	°C
	Soldering Temperature, for 10 sec.	300 (0.063 in. (1.6mm) from case)	

## Thermal - Mechanical Characteristics

	Parameter	Min.	Typ.	Max.	Units
$R_{\theta JC}$	Junction-to-Case, Single Leg Conducting	—	—	1.0	°C/W K/W
	Junction-to-Case, Both Legs Conducting	—	—	0.50	
$R_{\theta CS}$	Case-to-Sink, Flat, Greased Surface	—	0.10	—	
$Wt$	Weight	—	58 (2.0)	—	g (oz)
	Mounting Torque	35 (4.0)	—	50 (5.7)	lbf•in (N•m)

**Note:** ① Limited by junction temperature  
 ② L = 100μH, duty cycle limited by max  $T_J$   
 ③ 125°C

# HFA60MC60C

PD-2.463 rev. B 03/99

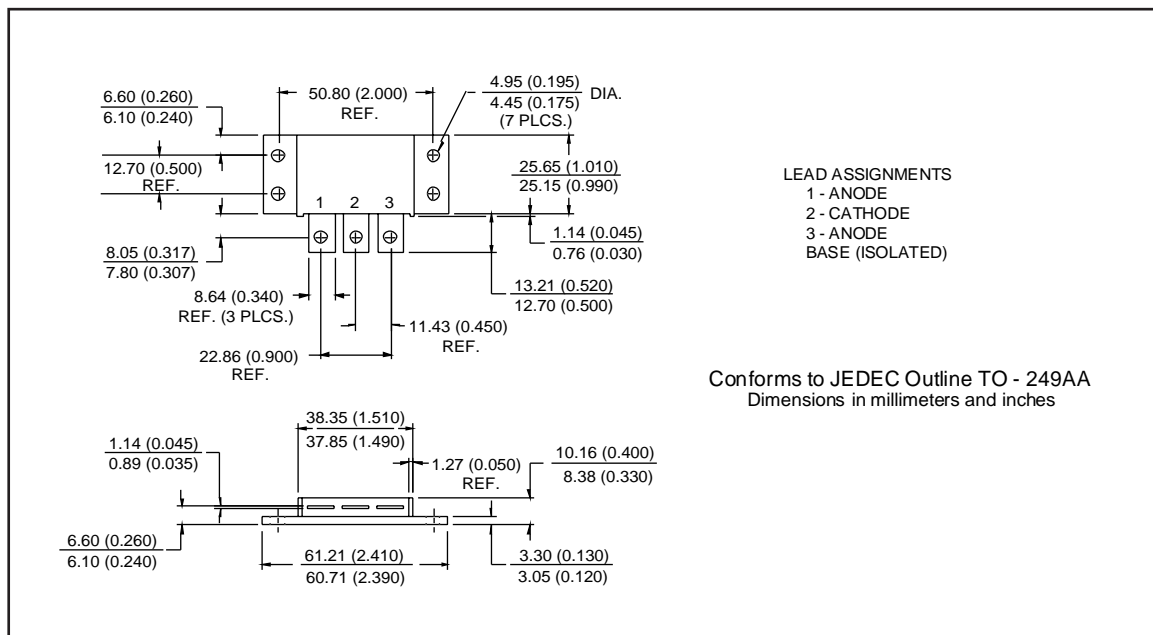
International  
**IOR** Rectifier

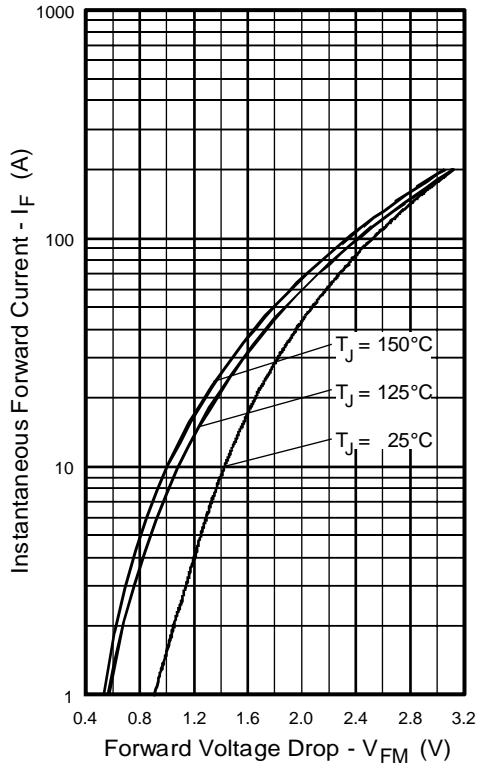
## Electrical Characteristics (per Leg) @ $T_J = 25^\circ\text{C}$ (unless otherwise specified)

	Parameter	Min.	Typ.	Max.	Units	Test Conditions
$V_{BR}$	Cathode Anode Breakdown Voltage	600	—	—	V	$I_R = 100\mu\text{A}$
$V_{FM}$	Max Forward Voltage	—	1.3	1.5	V	$I_F = 30\text{A}$ $I_F = 60\text{A}$ $I_F = 30\text{A}, T_J = 125^\circ\text{C}$ See Fig. 1
		—	1.4	1.7		
		—	1.1	1.3		
$I_{RM}$	Max Reverse Leakage Current	—	2.0	10	$\mu\text{A}$	$V_R = V_R$ Rated $T_J = 125^\circ\text{C}, V_R = 480\text{V}$ See Fig. 2
		—	0.50	2.0	$\text{mA}$	$T_J = 125^\circ\text{C}, V_R = 480\text{V}$ See Fig. 3
$C_T$	Junction Capacitance	—	68	100	$\text{pF}$	$V_R = 200\text{V}$ See Fig. 3
$L_S$	Series Inductance	—	8.0	—	$\text{nH}$	From terminal hole to terminal hole

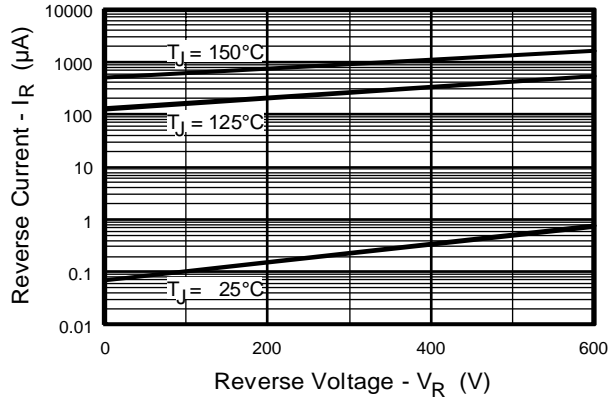
## Dynamic Recovery Characteristics (per Leg) @ $T_J = 25^\circ\text{C}$ (unless otherwise specified)

	Parameter	Min.	Typ.	Max.	Units	Test Conditions
$t_{rr}$	Reverse Recovery Time	—	30	—	ns	$I_F = 1.0\text{A}, di_f/dt = 200\text{A}/\mu\text{s}, V_R = 30\text{V}$ $T_J = 25^\circ\text{C}$ See Fig. 5 $T_J = 125^\circ\text{C}$ See Fig. 5 $I_F = 50\text{A}$ $V_R = 200\text{V}$
$t_{rr1}$		—	67	100		
$t_{rr2}$		—	112	170		
$I_{RRM1}$	Peak Recovery Current	—	6.0	11	A	$T_J = 25^\circ\text{C}$ See Fig. 6 $T_J = 125^\circ\text{C}$ See Fig. 6 $V_R = 200\text{V}$
$I_{RRM2}$		—	9.0	16		
$Q_{rr1}$	Reverse Recovery Charge	—	200	550	nC	$T_J = 25^\circ\text{C}$ See Fig. 7 $T_J = 125^\circ\text{C}$ See Fig. 7 $di_f/dt = 200\text{A}/\mu\text{s}$
$Q_{rr2}$		—	500	1400		
$di_{(rec)M}/dt1$	Peak Rate of Fall of Recovery Current During $t_b$	—	250	—	$\text{A}/\mu\text{s}$	$T_J = 25^\circ\text{C}$ See Fig. 8 $T_J = 125^\circ\text{C}$ See Fig. 8
$di_{(rec)M}/dt2$		—	170	—		

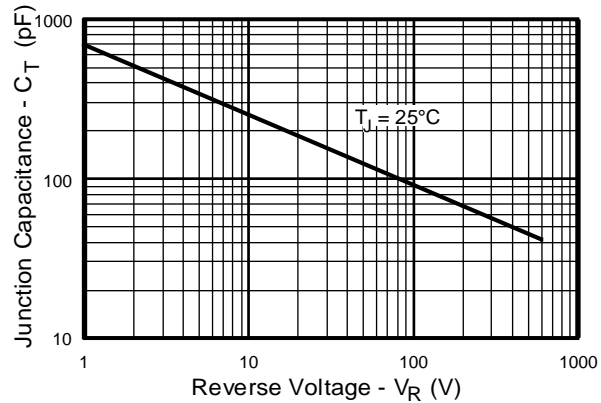




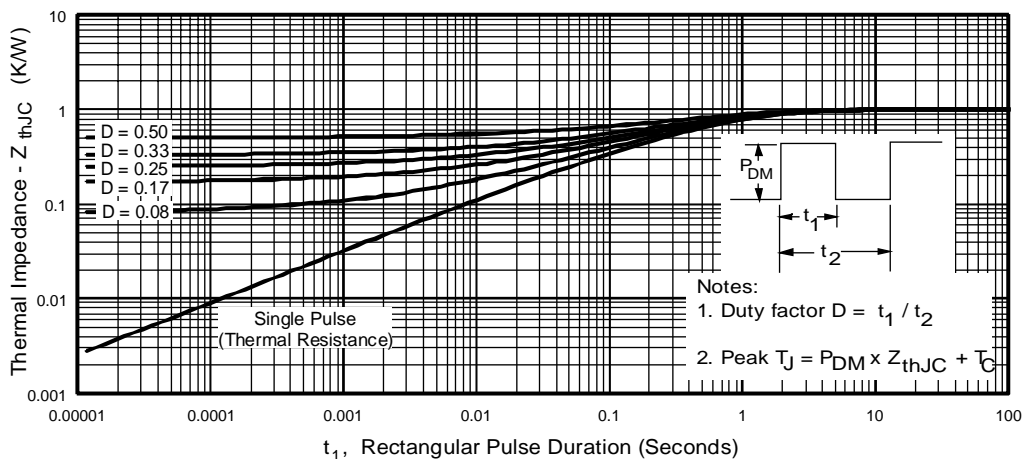
**Fig. 1 - Maximum Forward Voltage Drop vs. Instantaneous Forward Current, (per Leg)**



**Fig. 2 - Typical Reverse Current vs. Reverse Voltage, (per Leg)**



**Fig. 3 - Typical Junction Capacitance vs. Reverse Voltage, (per Leg)**

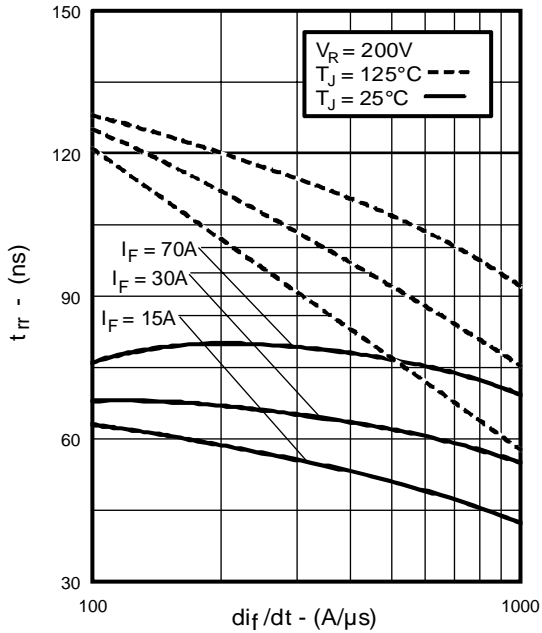


**Fig. 4 - Maximum Thermal Impedance  $Z_{thJC}$  Characteristics, (per Leg)**

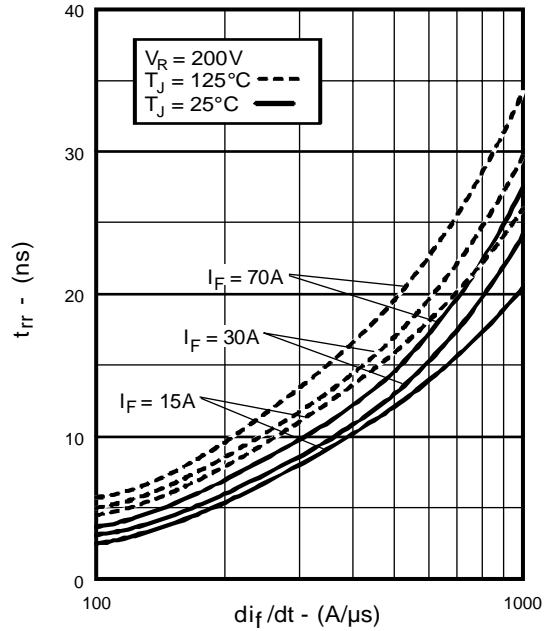
# HFA60MC60C

PD-2.463 rev. B 03/99

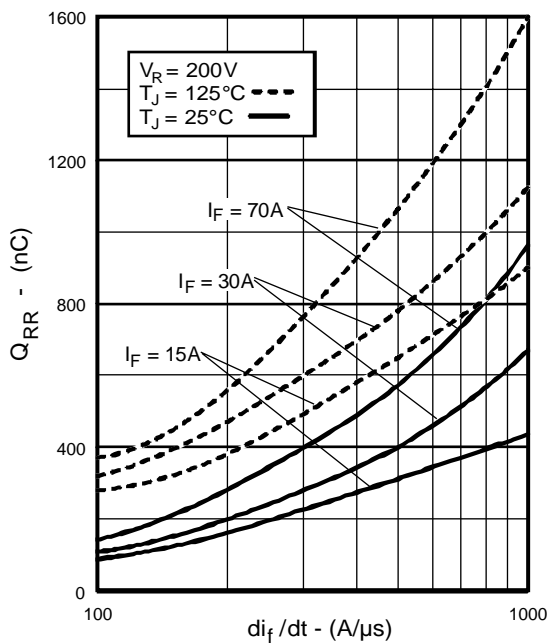
International  
**IOR** Rectifier



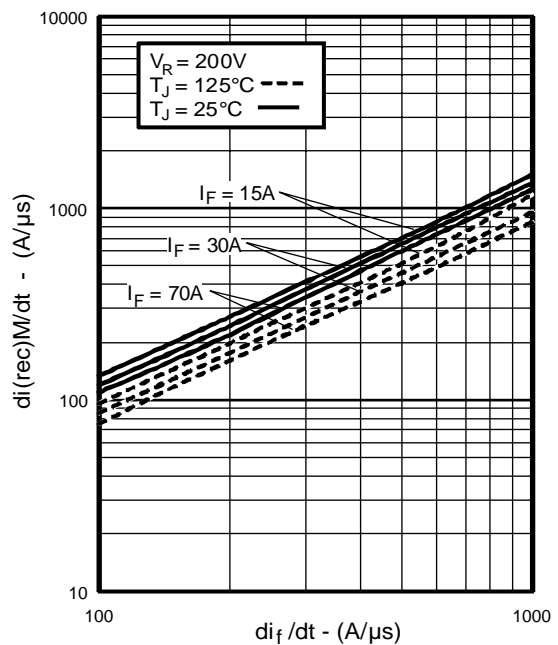
**Fig. 5** - Typical Reverse Recovery vs.  $di_f/dt$ , (per Leg)



**Fig. 6** - Typical Recovery Current vs.  $di_f/dt$ , (per Leg)



**Fig. 7** - Typical Stored Charge vs.  $di_f/dt$ , (per Leg)



**Fig. 8** - Typical  $di_{(rec)M}/dt$  vs.  $di_f/dt$ , (per Leg)

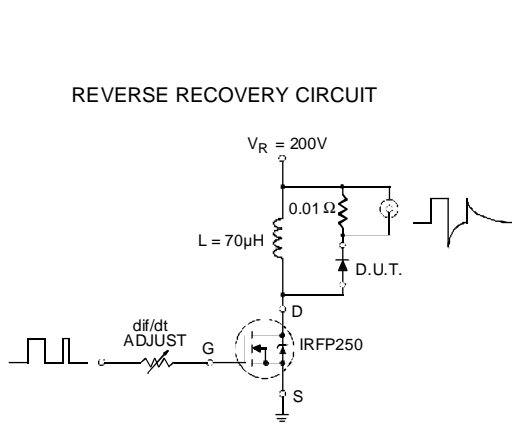
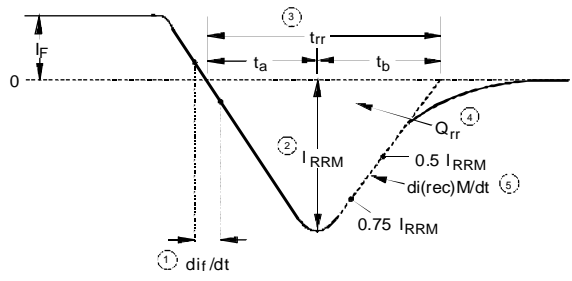


Fig. 9 - Reverse Recovery Parameter Test Circuit



1.  $di/dt$  - Rate of change of current through zero crossing
2.  $I_{RRM}$  - Peak reverse recovery current
3.  $t_{rr}$  - Reverse recovery time measured from zero crossing point of negative going  $I_F$  to point where a line passing through  $0.75 I_{RRM}$  and  $0.50 I_{RRM}$  extrapolated to zero current
4.  $Q_{rr}$  - Area under curve defined by  $t_{rr}$  and  $I_{RRM}$
5.  $di_{(rec)}/dt$  - Peak rate of change of current during  $t_b$  portion of  $t_{rr}$

$$Q_{rr} = \frac{t_{rr} \times I_{RRM}}{2}$$

Fig. 10 - Reverse Recovery Waveform and Definitions

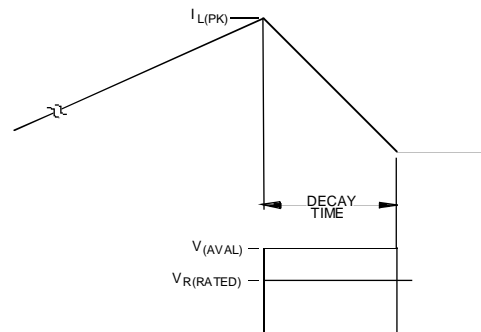
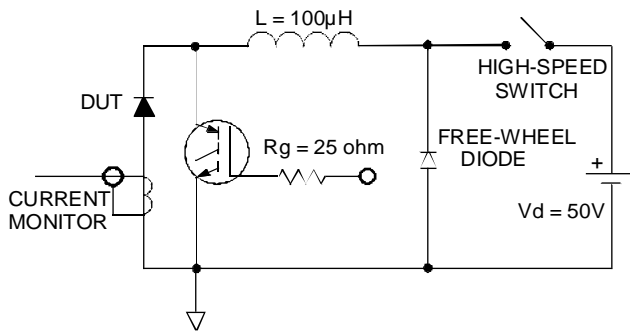


Fig. 11 - Avalanche Test Circuit and Waveforms