

600V Cascode GaN FET in PQFN88 (source tab)

Not recommended for new designs—see [TPH3206LSB](#)

Description

The TPH3206LS 600V, 150mΩ gallium nitride (GaN) FET is a normally-off device. Transphorm GaN FETs offer better efficiency through lower gate charge, faster switching speeds, and smaller reverse recovery charge, delivering significant advantages over traditional silicon (Si) devices.

Transphorm is a leading-edge wide band gap supplier with world-class innovation and a portfolio of fully-qualified GaN transistors that enables increased performance and reduced overall system size and cost.

Related Literature

- [AN0009](#): Recommended External Circuitry for GaN FETs
- [AN0003](#): Printed Circuit Board Layout and Probing

Ordering Information

Part Number*	Package	Package Configuration
TPH3206LS	8 x 8mm PQFN	Common Source

* Add "-TR" suffix for tape and reel; see page 9

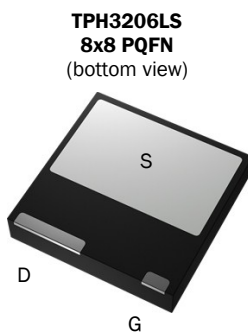

Features

- Easy to drive—compatible with standard gate drivers
- Low conduction and switching losses
- Low Qrr of 52nC—no free-wheeling diode required
- JEDEC-qualified GaN technology
- RoHS compliant and Halogen-free

Benefits

- Increased efficiency through fast switching
- Increased power density
- Reduced system size and weight
- Enables more efficient topologies—easy to implement bridgeless totem-pole designs
- Lower BOM cost

Applications

- Renewable energy
- Industrial
- Telecom and datacom
- Servo motors

Key Specifications	
V _{DS} (V) min	600
V _{TDS} (V) max	750
R _{DS(on)} (mΩ) max*	180
Q _{rr} (nC) typ	52
Q _g (nC) typ	6

* Dynamic R_(on)

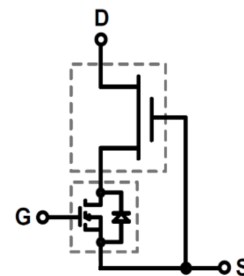

Cascode Device Structure

TPH3206LS

Absolute Maximum Ratings ($T_C=25^\circ\text{C}$ unless otherwise stated)

Symbol	Parameter	Limit Value	Unit	
$I_{D25^\circ\text{C}}$	Continuous drain current @ $T_C=25^\circ\text{C}$ ^a	17	A	
$I_{D100^\circ\text{C}}$	Continuous drain current @ $T_C=100^\circ\text{C}$ ^a	12	A	
I_{DM}	Pulsed drain current (pulse width: 100 μs)	60	A	
V_{DSS}	Drain to source voltage	600	V	
V_{TDS}	Transient drain to source voltage ^b	750	V	
V_{GSS}	Gate to source voltage	± 18	V	
$P_{D25^\circ\text{C}}$	Maximum power dissipation	96	W	
T_C	Operating temperature	Case	-55 to +150	$^\circ\text{C}$
T_J		Junction	-55 to +175	$^\circ\text{C}$
T_S	Storage temperature	-55 to +150	$^\circ\text{C}$	
T_{CSOLD}	Soldering peak temperature ^c	260	$^\circ\text{C}$	

Thermal Resistance

Symbol	Parameter	Typical	Unit
$R_{\theta JC}$	Junction-to-case	1.55	$^\circ\text{C}/\text{W}$
$R_{\theta JA}$	Junction-to-ambient ^d	45	$^\circ\text{C}/\text{W}$

Notes:

- For high current operation, see application note AN0009
- In off-state, spike duty cycle $D < 0.1$, spike duration $< 1\mu\text{s}$
- Reflow MSL3
- Device on one layer epoxy PCB for drain connection (vertical and without air stream cooling; with 6cm² copper area and 70 μm thickness)

TPH3206LS

Electrical Parameters (T_C=25 °C unless otherwise stated)

Symbol	Parameter	Min	Typ	Max	Unit	Test Conditions
Forward Device Characteristics						
V _{DSS-MAX}	Maximum drain-source voltage	600	—	—	V	V _{GS} =0V
V _{GS(th)}	Gate threshold voltage ^e	1.65	2.1	2.6	V	V _{DS} =V _{GS} , I _D =500μA
R _{DS(on)}	Drain-source on-resistance (T _J =25 °C) ^a	—	150	180	mΩ	V _{GS} =8V, I _D =11A, T _J =25 °C
	Drain-source on-resistance (T _J =175 °C) ^a	—	340	—		V _{GS} =8V, I _D =11A, T _J =175 °C
I _{DSS}	Drain-to-source leakage current (T _J =25 °C)	—	2.5	30	μA	V _{DS} =600V, V _{GS} =0V, T _J =25 °C
	Drain-to-source leakage current (T _J =150 °C)	—	8	—		V _{DS} =600V, V _{GS} =0V, T _J =150 °C
I _{GSS}	Gate-to-source forward leakage current	—	—	100	nA	V _{GS} =18V
	Gate-to-source reverse leakage current	—	—	-100		V _{GS} =-18V
C _{ISS}	Input capacitance	—	760	—	pF	V _{GS} =0V, V _{DS} =480V, f=1MHz
C _{OSS}	Output capacitance	—	44	—		
C _{RSS}	Reverse transfer capacitance	—	5	—		
C _{O(er)}	Output capacitance, energy related ^b	—	64	—	pF	V _{GS} =0V, V _{DS} =0V to 480V
C _{O(tr)}	Output capacitance, time related ^c	—	105	—		
Q _g	Total gate charge ^d	—	6.2	9.3	nC	V _{DS} =100V, V _{GS} =0V to 4.5V, I _D =11A
Q _{gs}	Gate-source charge	—	2.1	—		
Q _{gd}	Gate-drain charge	—	2.2	—		
t _{d(on)}	Turn-on delay	—	6	—	ns	V _{DS} =480V, V _{GS} =0V to 10V, I _D =11A, R _G =2Ω
t _r	Rise time	—	4.5	—		
T _{d(off)}	Turn-off delay	—	9.7	—		
t _f	Fall time	—	4	—		
Reverse Device Characteristics						
I _S	Reverse current	—	—	12	A	V _{GS} =0V, T _C =100 °C, ≤50% Duty Cycle
V _{SD}	Reverse voltage ^a	—	2.6	—	V	V _{GS} =0V, I _S =12A, T _J =25 °C
		—	4.6	—		V _{GS} =0V, I _S =12A, T _J =175 °C
		—	1.8	—		V _{GS} =0V, I _S =6A, T _J =25 °C
t _{rr}	Reverse recovery time	—	17	—	ns	I _S =11A, V _{DD} =400V, di/dt=2000A/μs, T _J =25 °C
Q _{rr}	Reverse recovery charge	—	52	—	nC	

Notes:

- Dynamic value
- Equivalent capacitance to give same stored energy from 0V to 480V
- Equivalent capacitance to give same charging time from 0V to 480V
- Q_g does not change for V_{DS}>100V
- Recommended gate drive: Turn on +8V, turn off 0 or -5V. For half bridge, use isolated driver ICs with 5V UVLO.

TPH3206LS

Typical Characteristics (25 °C unless otherwise stated)

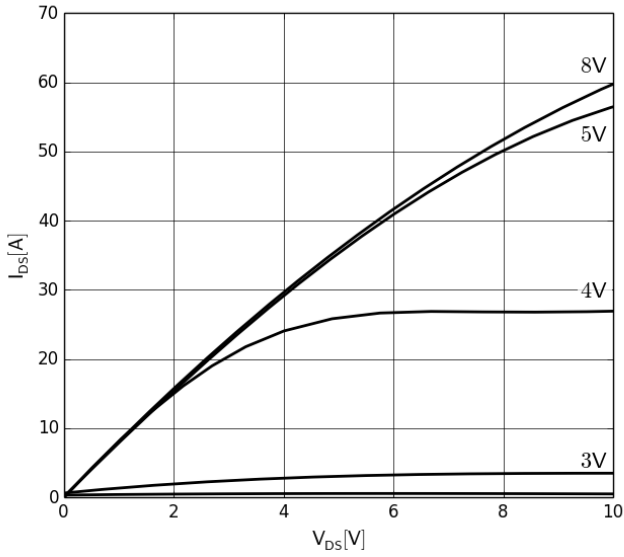

Figure 1. Typical Output Characteristics $T_J=25^\circ\text{C}$
Parameter: V_{GS}

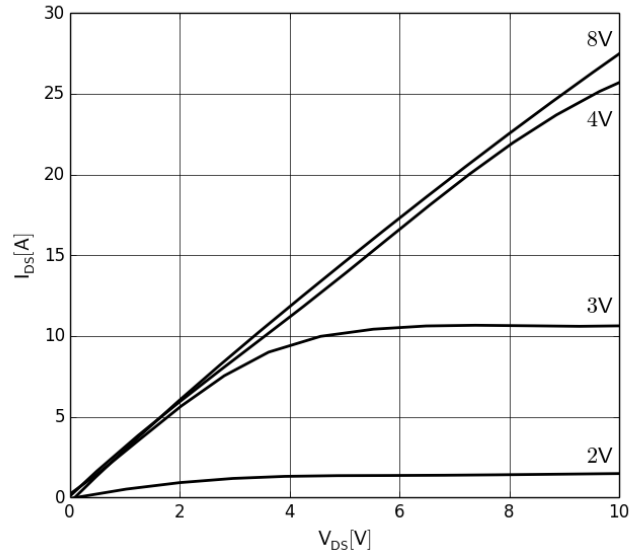

Figure 2. Typical Output Characteristics $T_J=175^\circ\text{C}$
Parameter: V_{GS}

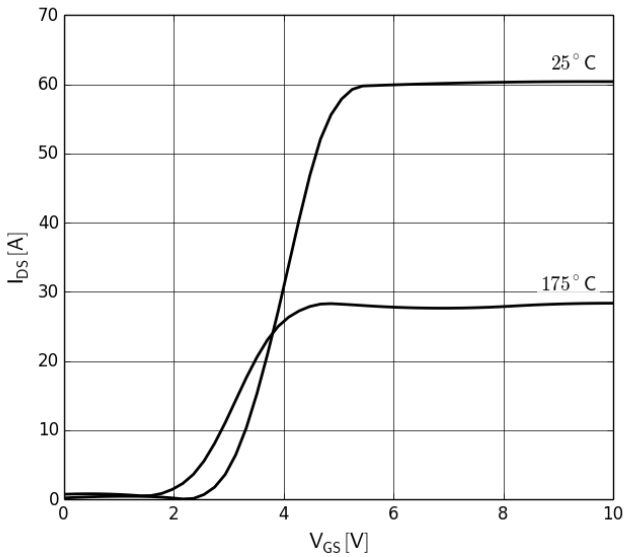

Figure 3. Typical Transfer Characteristics
 $V_{DS}=10\text{V}$, Parameter: T_J

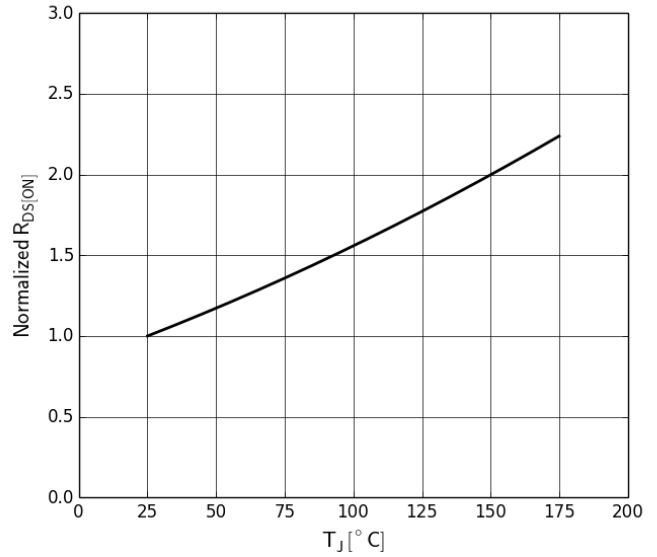

Figure 4. Normalized On-Resistance
 $I_D=12\text{A}$, $V_{GS}=8\text{V}$

TPH3206LS

Typical Characteristics (25 °C unless otherwise stated)

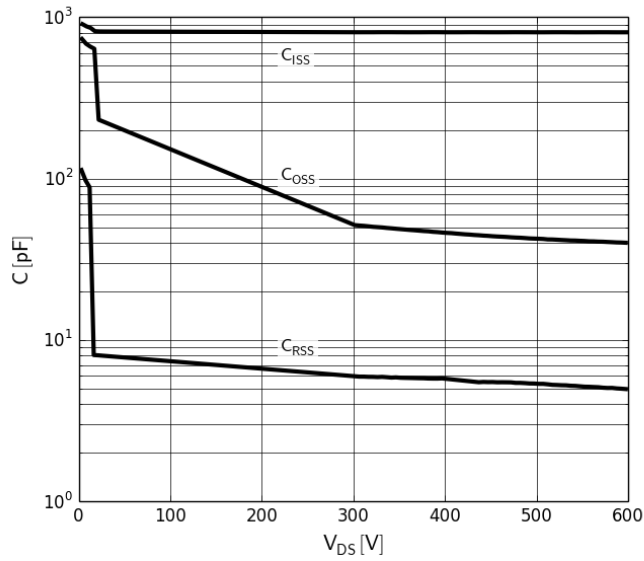

Figure 5. Typical Capacitance

$V_{GS}=0V, f=1MHz$

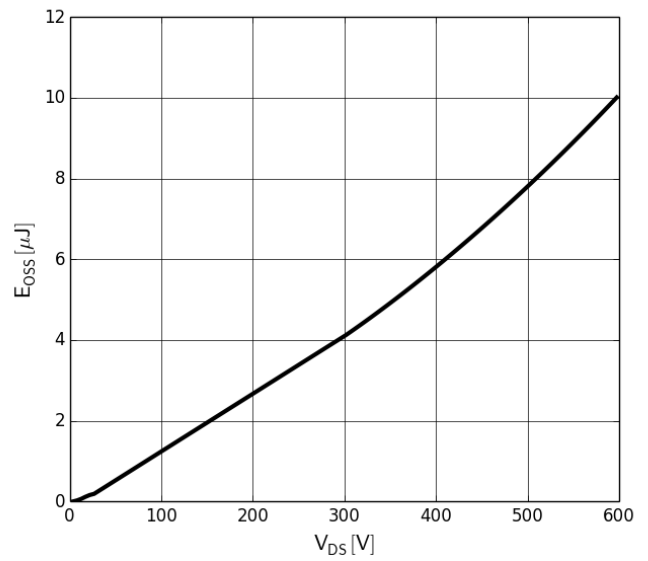

Figure 6. Typical C_{oss} Stored Energy

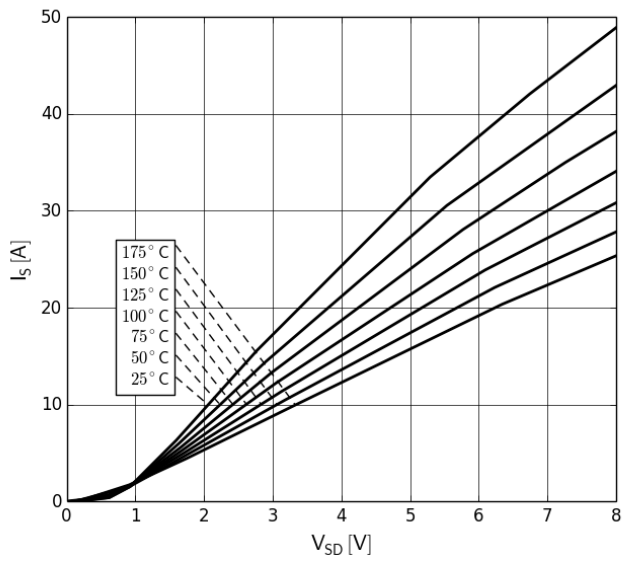

Figure 7. Forward Characteristics of Rev. Diode

$I_s=f(V_{SD}), \text{Parameter } T_j$

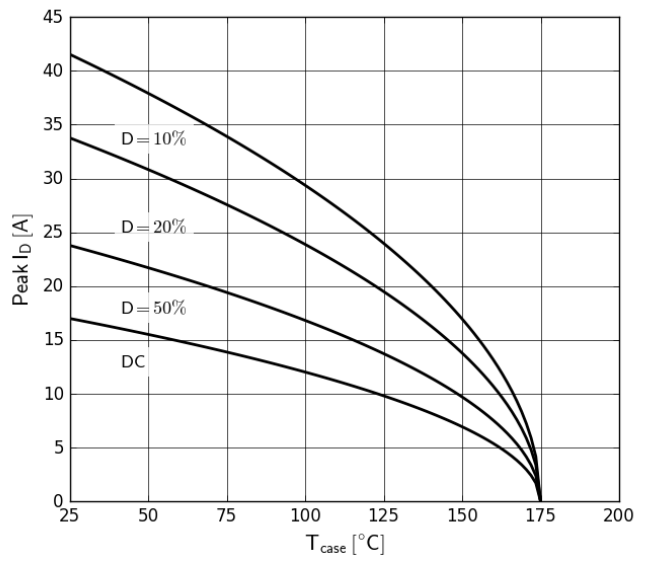
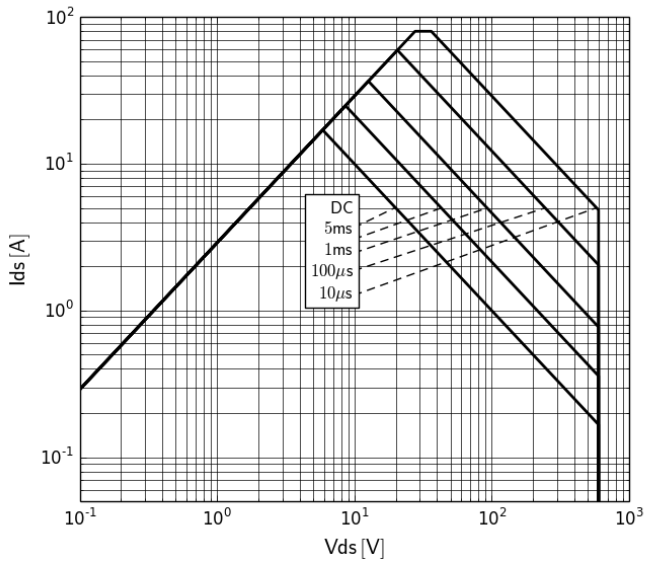

Figure 8. Current Derating

Pulse width $\leq 100\mu s$

TPH3206LS

Typical Characteristics (25 °C unless otherwise stated)



**Figure 9. Safe Operating Area $T_C=25^\circ\text{C}$
(calculated based on thermal limit)**

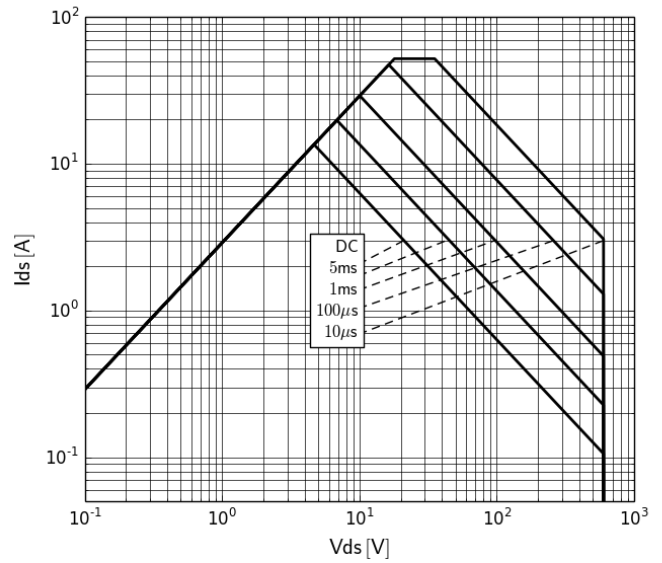

**Figure 10. Safe Operating Area $T_C=80^\circ\text{C}$
(calculated based on thermal limit)**

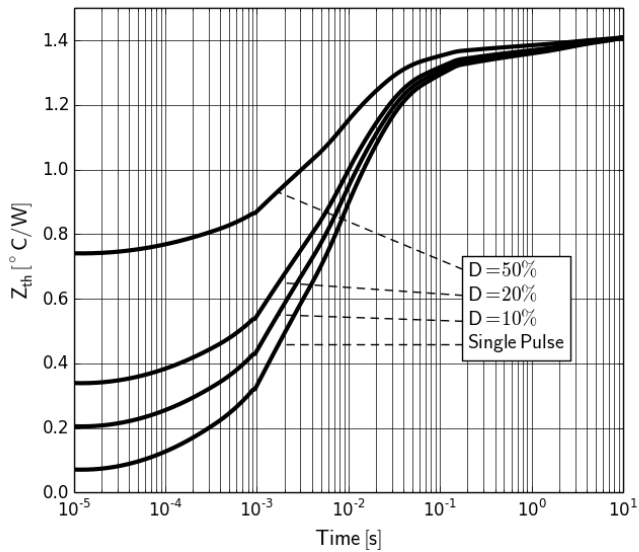

Figure 11. Transient Thermal Resistance

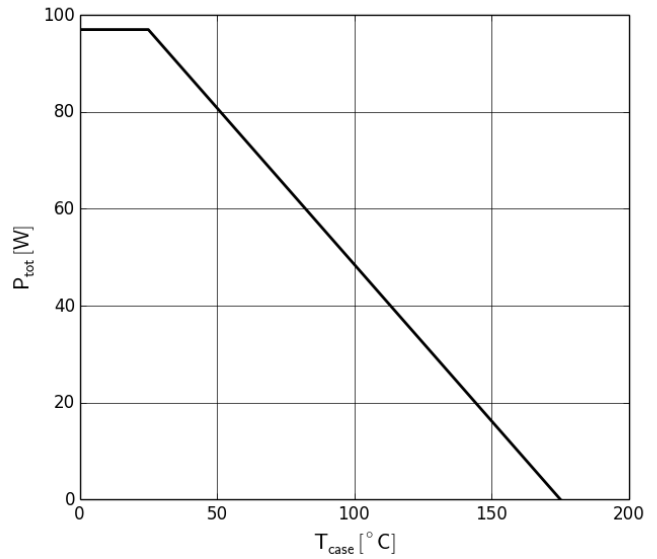

Figure 12. Power Dissipation

TPH3206LS

Test Circuits and Waveforms

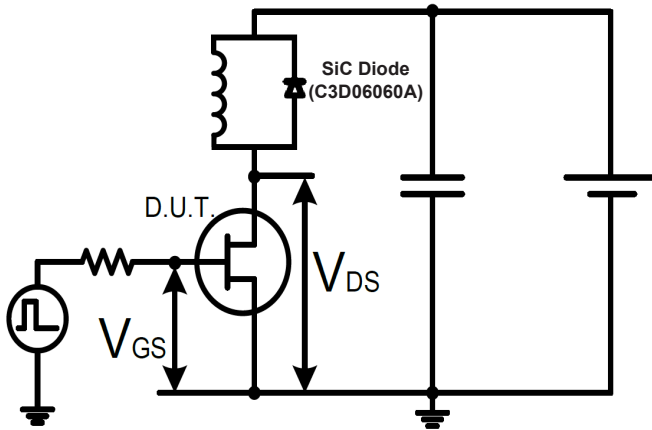

Figure 13. Switching Time Test Circuit
*See app note AN0009 for methods to ensure clean switching

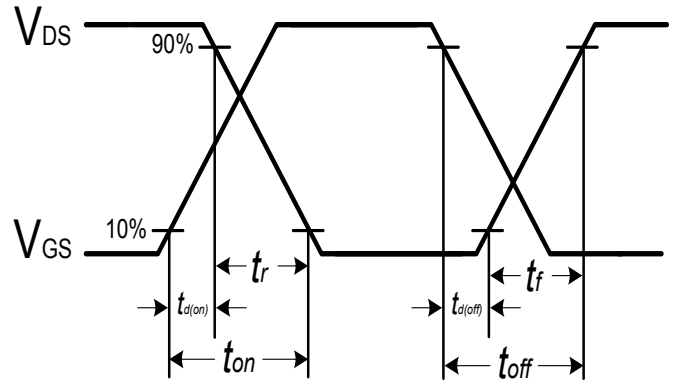

Figure 14. Switching Time Waveform

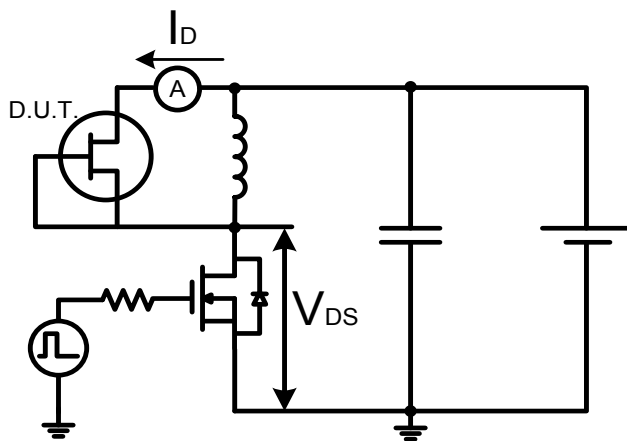

Figure 15. Test Circuit for Diode Characteristics

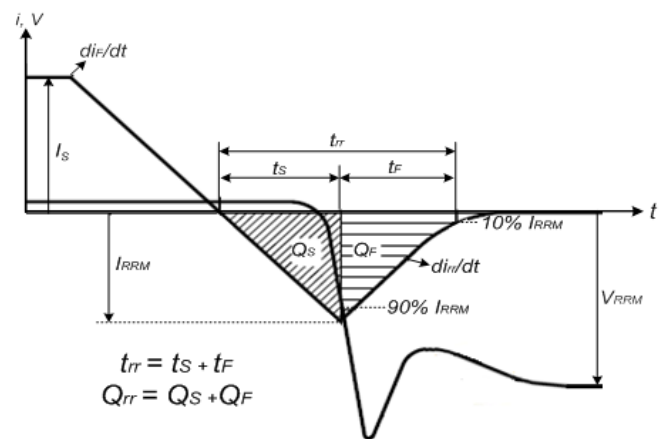

Figure 16. Diode Recovery Waveform

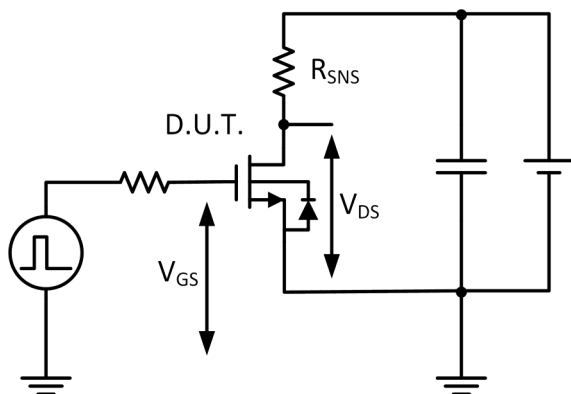

Figure 17. Test Circuit for Dynamic $R_{DS(on)}$

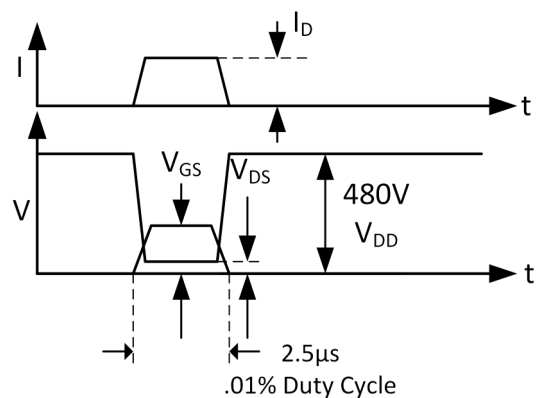
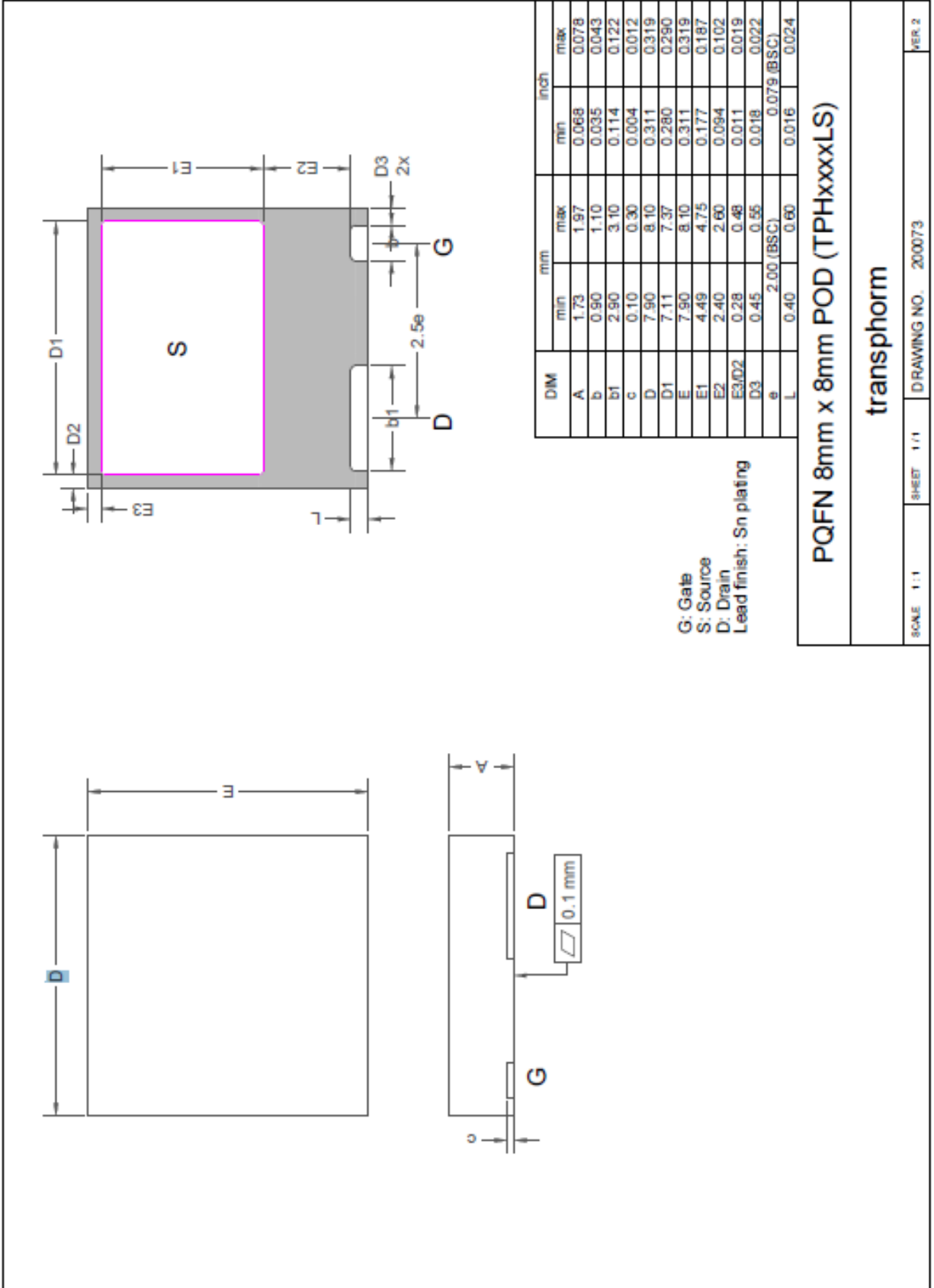

Figure 18. Dynamic $R_{DS(on)}$ Waveform

TPH3206LS



TPH3206LS

Design Considerations

The fast switching of GaN devices reduces current-voltage cross-over losses and enables high frequency operation while simultaneously achieving high efficiency. However, taking full advantage of the fast switching characteristics of GaN switches requires adherence to specific PCB layout guidelines and probing techniques.

Before evaluating Transphorm GaN devices, see application note [Printed Circuit Board Layout and Probing for GaN Power Switches](#). The table below provides some practical rules that should be followed during the evaluation.

When Evaluating Transphorm GaN Devices:

DO	DO NOT
Minimize circuit inductance by keeping traces short, both in the drive and power loop	Twist the pins of TO-220 or TO-247 to accommodate GDS board layout
Minimize lead length of TO-220 and TO-247 package when mounting to the PCB	Use long traces in drive circuit, long lead length of the devices
Use shortest sense loop for probing; attach the probe and its ground connection directly to the test points	Use differential mode probe or probe ground clip with long wire
See AN0003 : Printed Circuit Board Layout and Probing	

Application Notes

- [AN0002](#): Characteristics of Transphorm GaN Power Switches
- [AN0003](#): Printed Circuit Board Layout and Probing
- [AN0004](#): Designing Hard-switched Bridges with GaN
- [AN0007](#): PQFN Lead-Free 2nd Level Soldering Recommendations for Vapor Phase Reflow
- [AN0008](#): Drain Voltage and Avalanche Ratings for GaN FETs
- [AN0009](#): Recommended External Circuitry for GaN FETs

Evaluation Boards

- TDPV1000EOC1-KIT: 1kW inverter evaluation platform
- TDPS1000EOE10-KIT: 1kW hard-switched half-bridge, buck, or boost evaluation platform

TPH3206LS

Revision History

Version	Date	Change(s)
7	11/15/2016	Added application note AN0009
8	12/12/2016	Formatting Changes to p. 3, revision of dynamic measurement verbiage
9	2/20/2017	Updated ordering info, updated evaluation board list, added gate drive suggestion, marked NRND—see TPH3206LSB