

Insulated Gate Bipolar Transistor (Trench IGBT), 80 A



SOT-227

PRIMARY CHARACTERISTICS	
V_{CES}	1200 V
I_C DC	80 A at 104 °C
$V_{CE(on)}$ typical at 80 A, 25 °C	2.0 V
Speed	8 kHz to 30 kHz
Package	SOT-227
Circuit configuration	Single switch

FEATURES

- Trench IGBT technology
- Positive $V_{CE(on)}$ temperature coefficient
- Square RBSOA
- 10 μ s short circuit capability
- HEXFRED® low Q_{rr} , low switching energy
- T_J maximum = 150 °C
- Fully isolated package
- Very low internal inductance (≤ 5 nH typical)
- Industry standard outline
- UL approved file E78996 
- Material categorization: for definitions of compliance please see www.vishay.com/doc?99912

**RoHS
COMPLIANT**

BENEFITS

- Designed for increased operating efficiency in power conversion: UPS, SMPS, welding, induction heating
- Easy to assemble and parallel
- Direct mounting to heatsink
- Plug-in compatible with other SOT-227 packages
- Low EMI, requires less snubbing

ABSOLUTE MAXIMUM RATINGS				
PARAMETER	SYMBOL	TEST CONDITIONS	MAX.	UNITS
Collector to emitter voltage	V_{CES}		1200	V
Continuous collector current	I_C ⁽¹⁾	$T_C = 25$ °C	139	A
		$T_C = 90$ °C	93	
Pulsed collector current	I_{CM}		170	
Clamped inductive load current	I_{LM}		250	
Diode continuous forward current	I_F	$T_C = 25$ °C	98	
		$T_C = 90$ °C	61	
Single pulse forward current	I_{FSM}	10 ms sine or 6 ms rectangular pulse, $T_J = 25$ °C	350	
Gate to emitter voltage	V_{GE}		± 20	V
Power dissipation, IGBT	P_D	$T_C = 25$ °C	658	W
		$T_C = 90$ °C	316	
Power dissipation, diode	P_D	$T_C = 25$ °C	403	
		$T_C = 90$ °C	194	
Isolation voltage	V_{ISOL}	Any terminal to case, $t = 1$ min	2500	

Note

⁽¹⁾ Maximum collector current admitted is 100 A, to do not exceed the maximum temperature of terminals



ELECTRICAL SPECIFICATIONS (T _J = 25 °C unless otherwise specified)						
PARAMETER	SYMBOL	TEST CONDITIONS	MIN.	TYP.	MAX.	UNITS
Collector to emitter breakdown voltage	V _{BR(CES)}	V _{GE} = 0 V, I _C = 2.6 mA	1200	-	-	
Collector to emitter voltage	V _{CE(on)}	V _{GE} = 15 V, I _C = 80 A	-	2.0	2.55	V
		V _{GE} = 15 V, I _C = 80 A, T _J = 125 °C	-	2.4	-	
		V _{GE} = 15 V, I _C = 80 A, T _J = 150 °C	-	2.5	-	
Gate threshold voltage	V _{GE(th)}	V _{CE} = V _{GE} , I _C = 2.6 mA	4.75	5.7	7.0	
Temperature coefficient of threshold voltage	ΔV _{GE(th)} /ΔT _J	V _{CE} = V _{GE} , I _C = 2.6 mA (25 °C to 125 °C)	-	-12	-	mV/°C
Collector to emitter leakage current	I _{CES}	V _{GE} = 0 V, V _{CE} = 1200 V	-	1.0	100	μA
		V _{GE} = 0 V, V _{CE} = 1200 V, T _J = 125 °C	-	0.9	-	mA
Forward voltage drop	V _{FM}	I _F = 80 A, V _{GE} = 0 V	-	2.9	3.5	V
		I _F = 80 A, V _{GE} = 0 V, T _J = 125 °C	-	3.1	-	
		I _F = 80 A, V _{GE} = 0 V, T _J = 150 °C	-	3.1	-	
Gate to emitter leakage current	I _{GES}	V _{GE} = ± 20 V	-	-	± 220	nA

SWITCHING CHARACTERISTICS (T _J = 25 °C unless otherwise specified)							
PARAMETER	SYMBOL	TEST CONDITIONS	MIN.	TYP.	MAX.	UNITS	
Total gate charge (turn-on)	Q _g	V _{GE} = -15 V, V _{GE} = ± 15 V	-	570	-		
Input capacitance	C _{ies}	V _{CE} = 25 V, V _{GE} = 0 V, f = 1 MHz	-	4400	-	pF	
Reverse transfer capacitance	C _{res}		-	235	-		
Turn-on switching loss	E _{on}	I _C = 80 A, V _{CC} = 600 V, V _{GE} = 15 V, R _g = 1.0 Ω, L = 500 μH, T _J = 25 °C	-	3.0	-	mJ	
Turn-off switching loss	E _{off}		-	3.2	-		
Total switching loss	E _{tot}		-	6.2	-		
Turn-on switching loss	E _{on}	I _C = 80 A, V _{CC} = 600 V, V _{GE} = 15 V, R _g = 1.0 Ω, L = 500 μH, T _J = 125 °C	-	3.9	-	mJ	
Turn-off switching loss	E _{off}		-	5.5	-		
Total switching loss	E _{tot}		-	9.4	-		
Turn-on delay time	t _{d(on)}		Energy losses include tail and diode recovery Diode used HFA16PB120	-	134	-	ns
Rise time	t _r			-	65	-	
Turn-off delay time	t _{d(off)}			-	281	-	
Fall time	t _f	-		155	-		
Reverse bias safe operating area	RBSOA	T _J = 150 °C, I _C = 250 A, R _g = 1.0 Ω, V _{GE} = 15 V to 0 V, V _{CC} = 800 V, V _P = 1200 V, L = 500 μH	Fullsquare				
Diode reverse recovery time	t _{rr}	I _F = 50 A, dI _F /dt = 200 A/μs, V _R = 400 V	-	179	-	ns	
Diode peak reverse current	I _{rr}		-	11.5	-	A	
Diode recovery charge	Q _{rr}		-	1029	-	nC	
Diode reverse recovery time	t _{rr}	I _F = 50 A, dI _F /dt = 200 A/μs, V _{rr} = 400 V, T _J = 125 °C	-	275	-	ns	
Diode peak reverse current	I _{rr}		-	17.8	-	A	
Diode recovery charge	Q _{rr}		-	2451	-	nC	
Short circuit safe operating area	SCSOA	V _{GE} = 15 V, V _{CC} = 800 V, V _{CE} max. = 1200 V, T _J = 150 °C	10			μs	

THERMAL AND MECHANICAL SPECIFICATIONS						
PARAMETER	SYMBOL	TEST CONDITIONS	MIN.	TYP.	MAX.	UNITS
Junction and storage temperature range	T _J , T _{Stg}		-40	-	150	°C
Junction to case	IGBT	R _{thJC}	-	-	0.19	°C/W
	Diode		-	-	0.31	
Case to heatsink	R _{thCS}	Flat, greased surface	-	0.1	-	
Weight			-	30	-	g
Mounting torque		Torque to terminal	-	-	1.1 (9.7)	Nm (lbf. in)
		Torque to heatsink	-	-	1.3 (11.5)	Nm (lbf. in)
Case style		SOT-227				

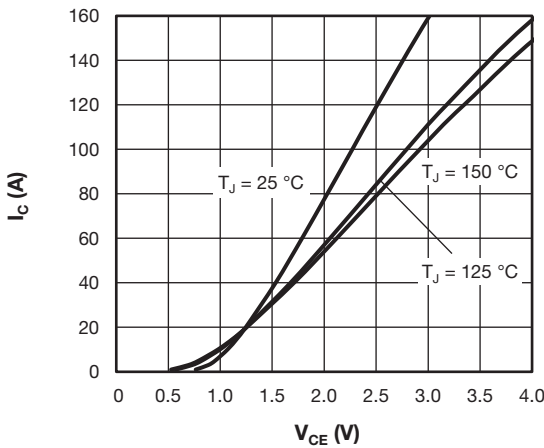

Fig. 1 - Typical IGBT Output Characteristics, $V_{GE} = 15\text{ V}$

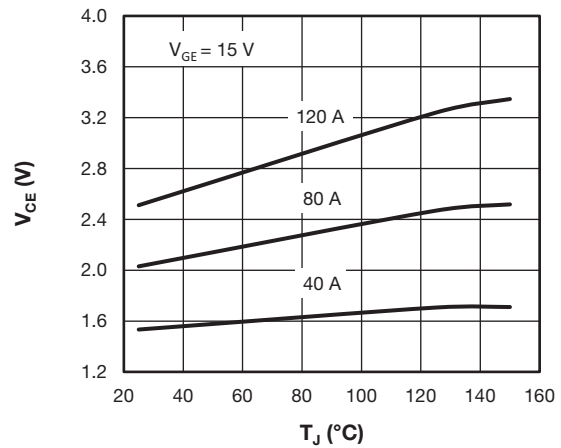

Fig. 4 - Collector to Emitter Voltage vs. Junction Temperature

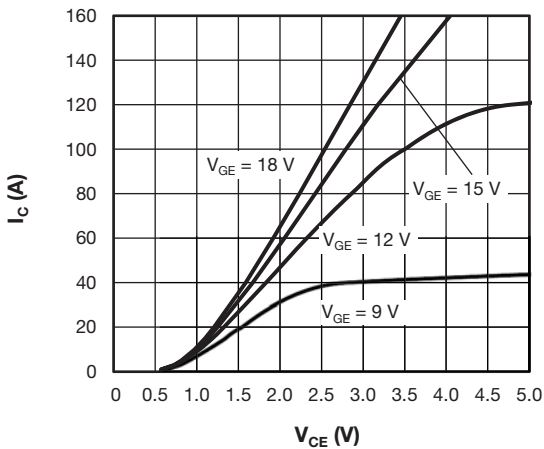

Fig. 2 - Typical IGBT Output Characteristics, $T_J = 125\text{ °C}$

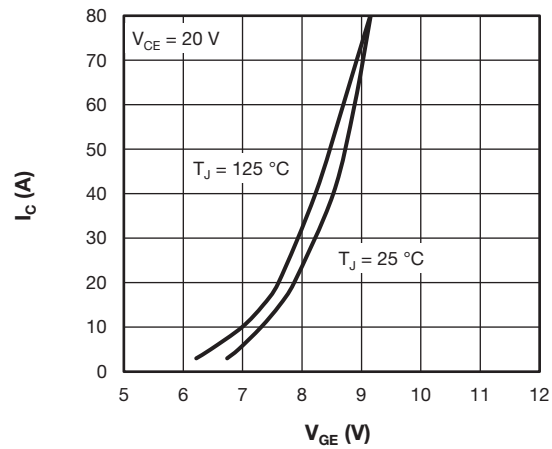

Fig. 5 - Typical IGBT Transfer Characteristics

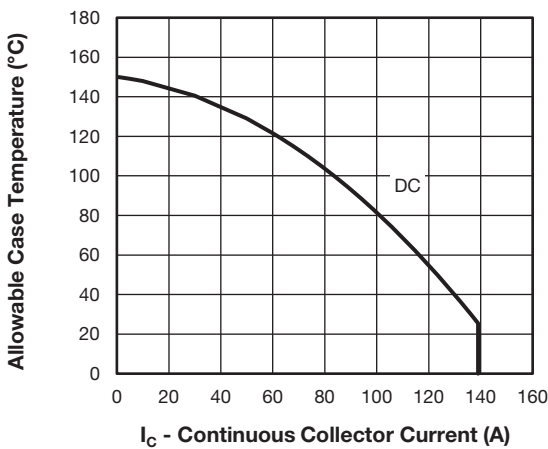

Fig. 3 - Maximum IGBT Continuous Collector Current vs. Case Temperature

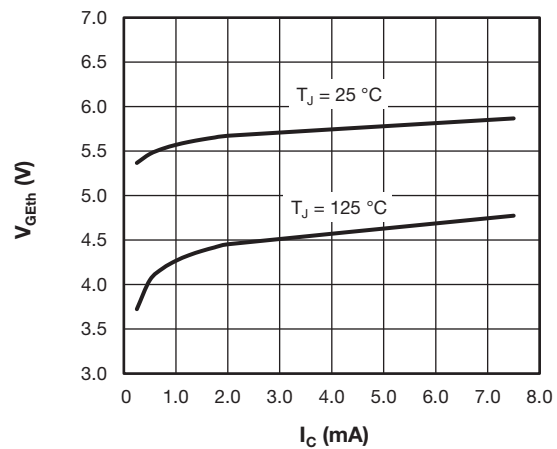

Fig. 6 - Typical IGBT Gate Threshold Voltage

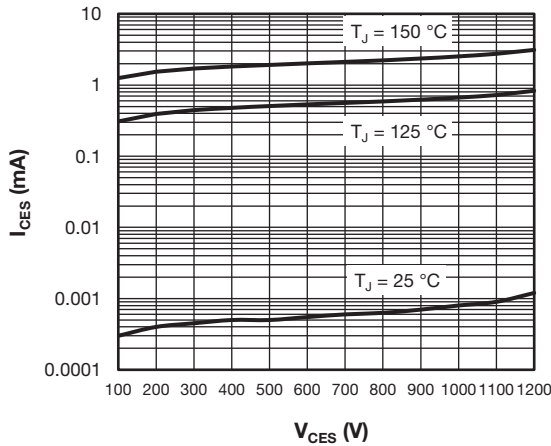

Fig. 7 - Typical IGBT Zero Gate Voltage Collector Current

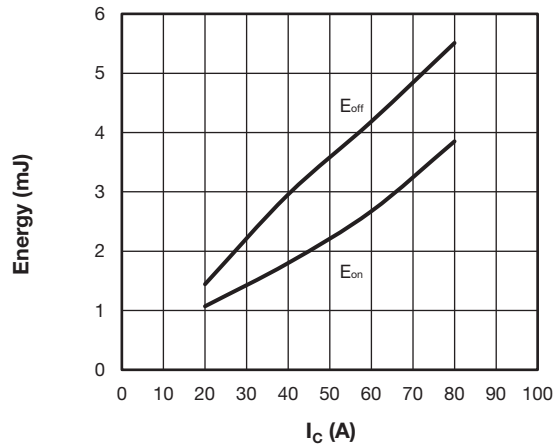

Fig. 10 - Typical IGBT Energy Loss vs I_C
 $T_J = 125\text{ }^\circ\text{C}$, $V_{CC} = 600\text{ V}$, $R_g = 1.0\ \Omega$, $V_{GE} = 15\text{ V}$, $L = 500\ \mu\text{H}$

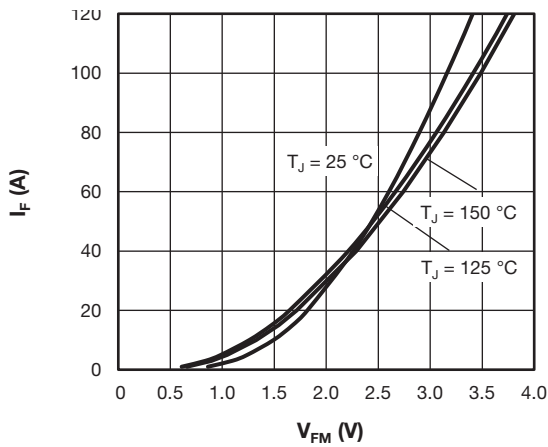

Fig. 8 - Typical Diode Forward Characteristics

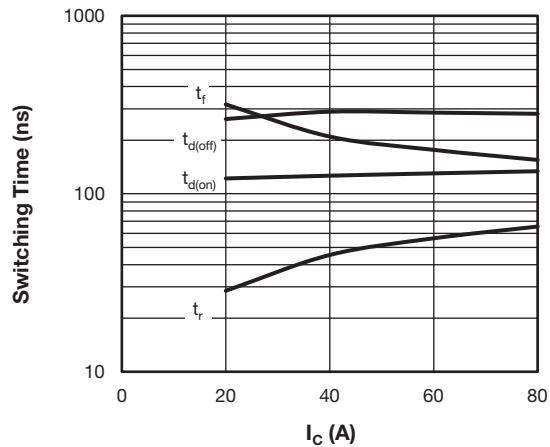

Fig. 11 - Typical IGBT Switching Time vs. I_C
 $T_J = 125\text{ }^\circ\text{C}$, $V_{CC} = 600\text{ V}$, $R_g = 1.0\ \Omega$, $V_{GE} = 15\text{ V}$, $L = 500\ \mu\text{H}$

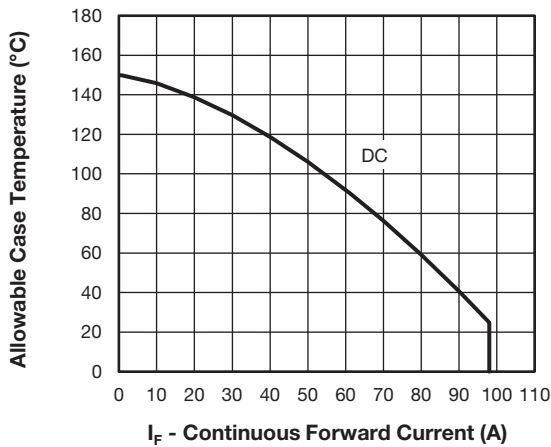

Fig. 9 - Maximum Diode Continuous Forward Current vs. Case Temperature

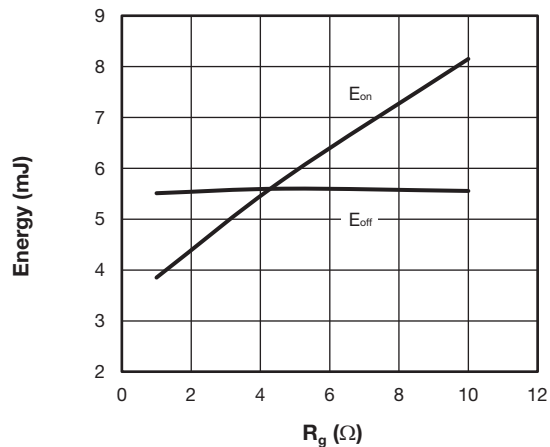

Fig. 12 - Typical IGBT Energy Loss vs. R_g
 $T_J = 125\text{ }^\circ\text{C}$, $V_{CC} = 600\text{ V}$, $I_C = 80\text{ A}$, $V_{GE} = 15\text{ V}$, $L = 500\ \mu\text{H}$

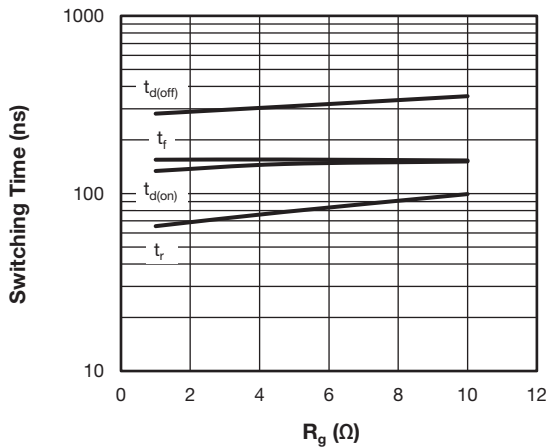

Fig. 13 - Typical IGBT Switching Time vs. R_g
 $T_J = 125^\circ\text{C}$, $V_{CC} = 600\text{ V}$, $I_C = 80\text{ A}$, $V_{GE} = 15\text{ V}$, $L = 500\ \mu\text{H}$

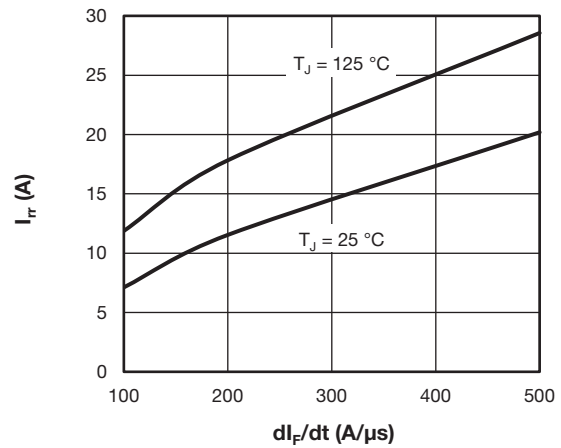

Fig. 15 - Typical Diode Reverse Recovery Current vs. di_F/dt
 $V_{rr} = 400\text{ V}$, $I_F = 50\text{ A}$

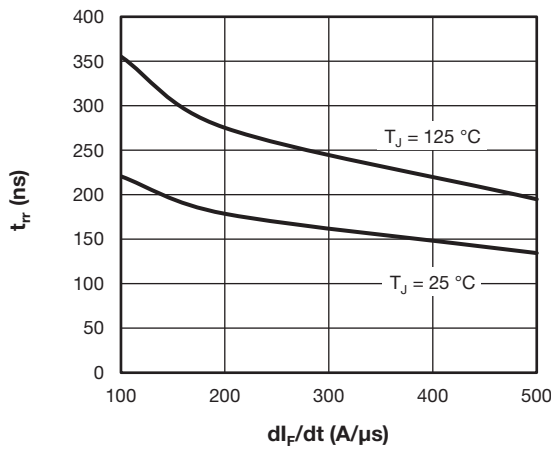

Fig. 14 - Typical Diode Reverse Recovery Time vs. di_F/dt
 $V_{rr} = 400\text{ V}$, $I_F = 50\text{ A}$

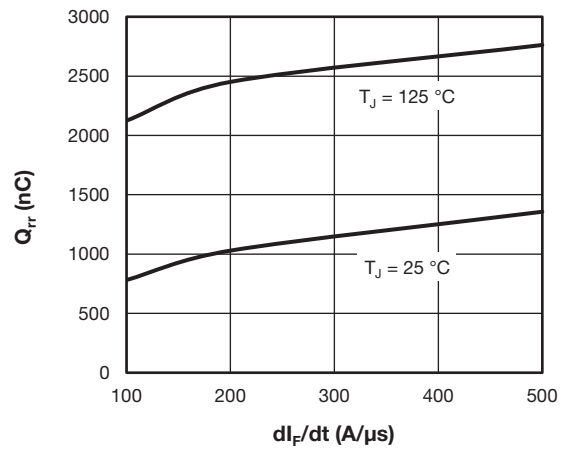

Fig. 16 - Typical Diode Reverse Recovery Charge vs. di_F/dt
 $V_{rr} = 400\text{ V}$, $I_F = 50\text{ A}$

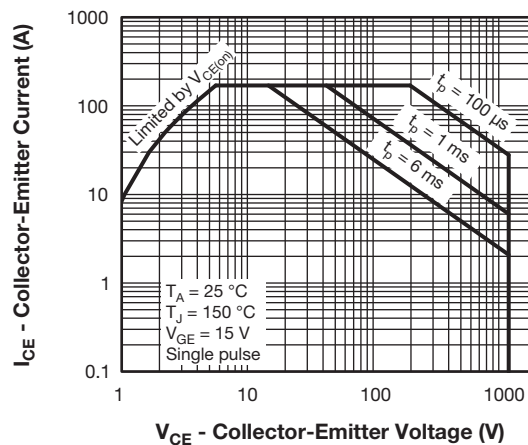

Fig. 17 - IGBT Safe Operating Area

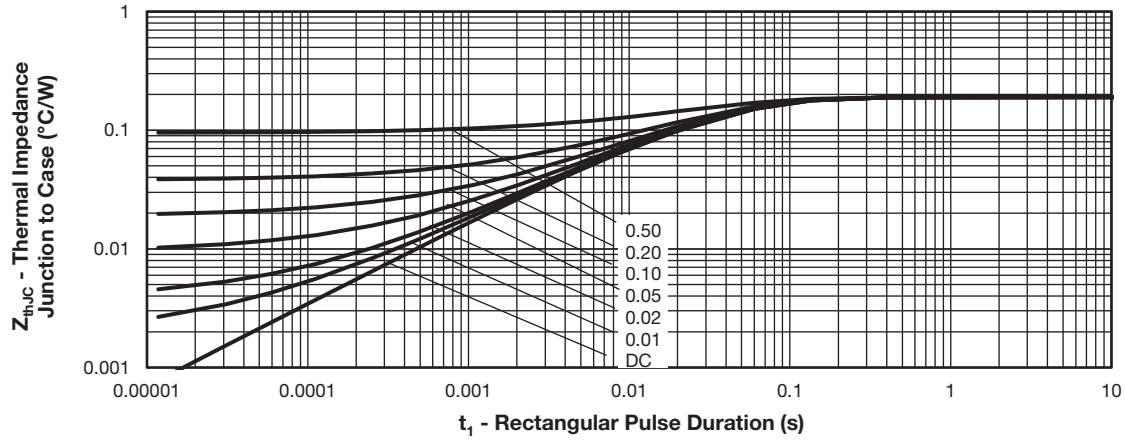

Fig. 18 - Maximum Thermal Impedance Z_{thJC} Characteristics (IGBT)

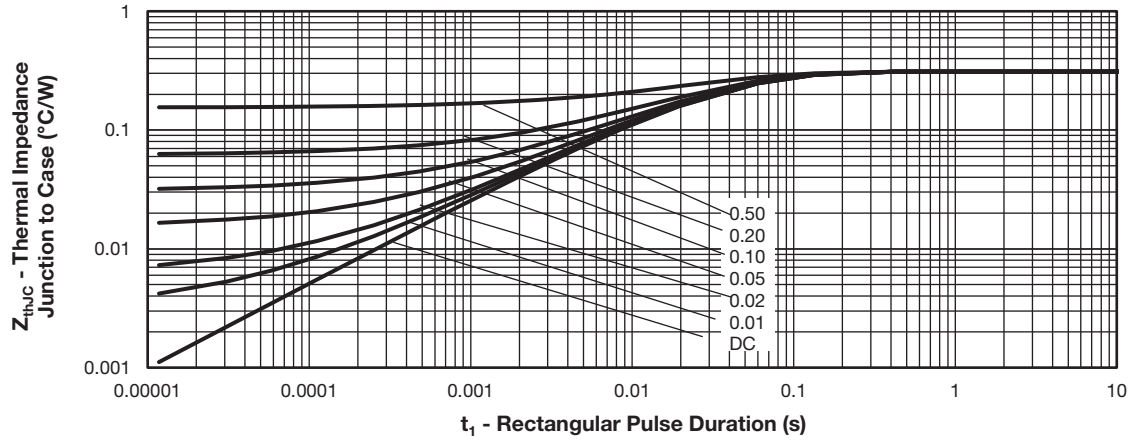

Fig. 19 - Maximum Thermal Impedance Z_{thJC} Characteristics (Diode)

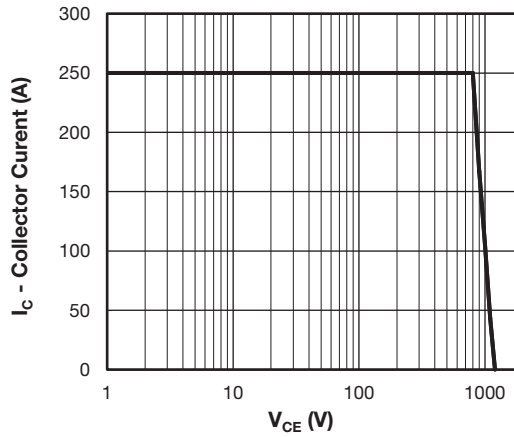
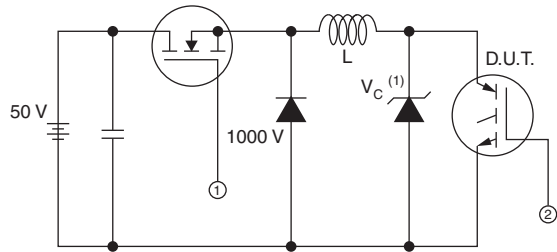

Fig. 20 - IGBT Reverse Bias SOA
 $V_{GE} = 15\text{ V}$, $T_J = 150\text{ °C}$



Note:

⁽¹⁾ Driver same type as D.U.T.; $V_C = 80\%$ of $V_{CE\ max}$.
Due to the 50 V power supply, pulse width, and inductor will increase to obtain I_D

Fig. 21 - Clamped Inductive Load Test Circuit

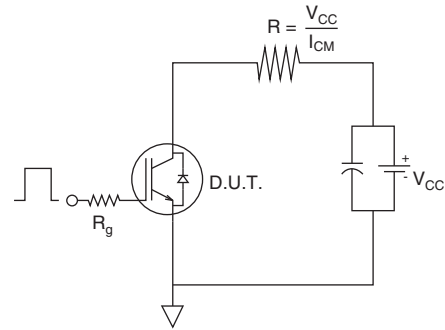

Fig. 22 - Pulsed Collector Current Test Circuit

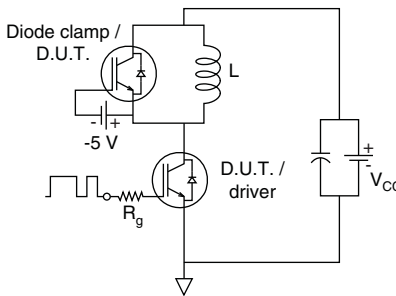

Fig. 23 - Switching Loss Test Circuit

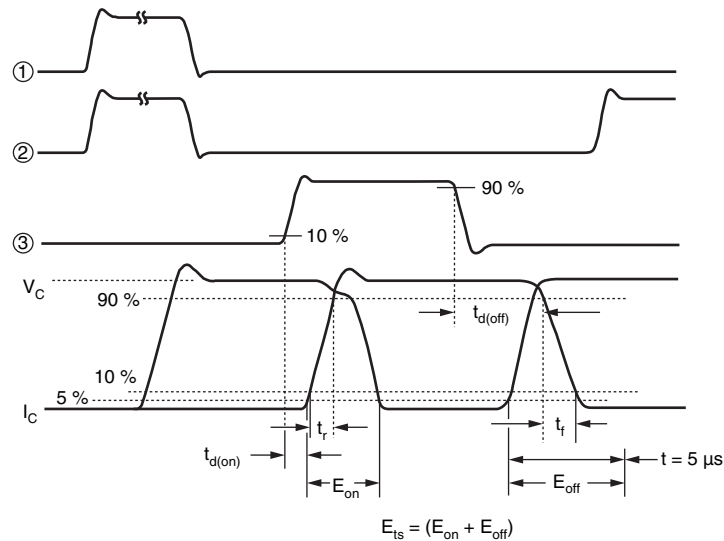

Fig. 24 - Switching Loss Waveforms Test Circuit

ORDERING INFORMATION TABLE

Device code	VS-	G	T	80	D	A	120	U
	①	②	③	④	⑤	⑥	⑦	⑧

- 1** - Vishay Semiconductors product
- 2** - Insulated gate bipolar transistor (IGBT)
- 3** - Trench IGBT technology
- 4** - Current rating (80 = 80 A)
- 5** - Circuit configuration (D = single switch with antiparallel diode)
- 6** - Package indicator (A = SOT-227)
- 7** - Voltage rating (120 = 1200 V)
- 8** - Speed / type (U = ultrafast)

CIRCUIT CONFIGURATION		
CIRCUIT	CIRCUIT CONFIGURATION CODE	CIRCUIT DRAWING
Single switch with antiparallel diode	D	

LINKS TO RELATED DOCUMENTS	
Dimensions	www.vishay.com/doc?95423
Packaging information	www.vishay.com/doc?95425



Disclaimer

ALL PRODUCT, PRODUCT SPECIFICATIONS AND DATA ARE SUBJECT TO CHANGE WITHOUT NOTICE TO IMPROVE RELIABILITY, FUNCTION OR DESIGN OR OTHERWISE.

Vishay Intertechnology, Inc., its affiliates, agents, and employees, and all persons acting on its or their behalf (collectively, "Vishay"), disclaim any and all liability for any errors, inaccuracies or incompleteness contained in any datasheet or in any other disclosure relating to any product.

Vishay makes no warranty, representation or guarantee regarding the suitability of the products for any particular purpose or the continuing production of any product. To the maximum extent permitted by applicable law, Vishay disclaims (i) any and all liability arising out of the application or use of any product, (ii) any and all liability, including without limitation special, consequential or incidental damages, and (iii) any and all implied warranties, including warranties of fitness for particular purpose, non-infringement and merchantability.

Statements regarding the suitability of products for certain types of applications are based on Vishay's knowledge of typical requirements that are often placed on Vishay products in generic applications. Such statements are not binding statements about the suitability of products for a particular application. It is the customer's responsibility to validate that a particular product with the properties described in the product specification is suitable for use in a particular application. Parameters provided in datasheets and / or specifications may vary in different applications and performance may vary over time. All operating parameters, including typical parameters, must be validated for each customer application by the customer's technical experts. Product specifications do not expand or otherwise modify Vishay's terms and conditions of purchase, including but not limited to the warranty expressed therein.

Except as expressly indicated in writing, Vishay products are not designed for use in medical, life-saving, or life-sustaining applications or for any other application in which the failure of the Vishay product could result in personal injury or death. Customers using or selling Vishay products not expressly indicated for use in such applications do so at their own risk. Please contact authorized Vishay personnel to obtain written terms and conditions regarding products designed for such applications.

No license, express or implied, by estoppel or otherwise, to any intellectual property rights is granted by this document or by any conduct of Vishay. Product names and markings noted herein may be trademarks of their respective owners.