

BK PRECISION® 312B

Instruction Manual

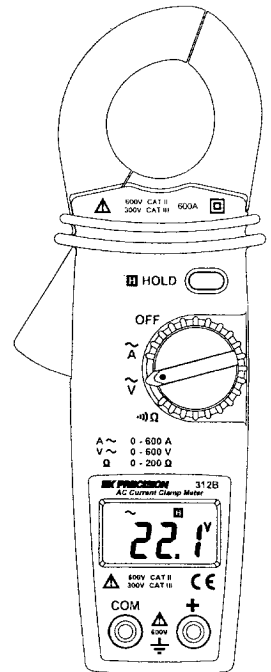

PN: 481-420-9-001
Printed in Taiwan
©2003 B&K Precision Corp.

B&K Precision Corp.
22820 Savi Ranch Parkway
Yorba Linda, CA. 92887
TEL: 714- 921-9095
FAX: 714-921-6422
www.bkprecision.com

CE

AC Current Clamp Meter

CONTENTS

TITLE	PAGE
I. Safety Information	1
Environmental Conditions.....	1
Explanation of Symbols.....	1
II. Specification	2
General Specification.....	2
Electrical Specification.....	2
III. Instrument Familiarization	3
Symbol Definition.....	3
IV. Measuring Instruction	5
4.1 ACA measurement.....	5
4.2 ACV measurement.....	6
4.3 Resistance measurement.....	7
4.4 Continuity Test.....	8
V. Battery Changing	9
VI. Maintenance	9

I. Safety Information

Do not operate the tester if the body of meter or the test lead look broken.

Check the main function dial and make sure it is at the correct position before each measurement.

Do not perform resistance and continuity test on a live power system.

Do not apply voltage between the test terminals and test terminal to ground that exceed the maximum limit refer in this manual.

Exercise extreme caution when measuring live system with voltage greater than 60V DC or 30V AC.

Keep the fingers after the protection ring when measuring through the test lead.

Change the battery when the  symbol appears to avoid incorrect data.

Environmental Conditions:



Altitude up to 2000 meters.

Operating temperature: 0°C ~ 40°C, <80% RH, non-condensing

Storage temperature: -10°C ~ 60°C, <70% RH, battery removed

Pollution Degree: 2

Explanation of Symbols:

-  Attention! Refer to operation Instructions.
-  Dangerous voltage may be present at terminals.
-  This instrument has double insulation.

Approvals:  EN61010 600V CAT II 300V CAT III

II. Specification

General Specification:

Digital Display:

3 1/2 digits LCD display with maximum reading 1999

Over Load:

When the indication is larger than the 1999 counts, the LCD will show 1000 with blinking 1

Sample Rate:

2 times/sec

Low Power Indication:

When the battery is under the proper operation range,  symbol will appear on the LCD display.

Power Source: UM-4 or AAA 1.5V battery x 2.

Clamp opening size: 25mm

Dimension (L x W x H) :

187x50x29mm, 7.36x1.97x1.14 inch

Weight: 210g (include battery)

Accessory:

Instruction Manual, Carrying Case, Test lead, Battery 1.5Vx2

Battery Life: 1000 hr approx. (alkaline battery)

Electrical Specification:

The accuracy specification is defined as $\pm (\dots \% \text{reading} + \dots \text{count})$
At $23 \pm 5^\circ\text{C}$, $\leq 80 \% \text{RH}$

ACA (Autorange)

Range	Resolution	Accuracy (50Hz~60Hz)	Overload Protection
200A	0.1A	2%+5	660Arms
600A	1A		

ACV (Autorange)

Range	Resolution	Accuracy (50Hz-500Hz)	Overload Protection
200V	0.1V	1.5%+5	660Vrms
600V	1V		

Ohm (Ω)

Range	Resolution	Accuracy	MAX Test Voltage	Overload Protection
200 Ω	0.1 Ω	1.9%+3	1.6Vdc	500Vrms

Continuity ($\cdot\cdot\cdot$)

Range	Active Region	MAX Test Voltage	Overload Protection
$\cdot\cdot\cdot$	<100 Ohm	1.6Vdc	500Vrms

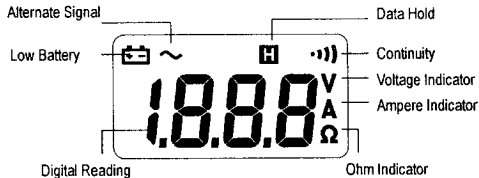
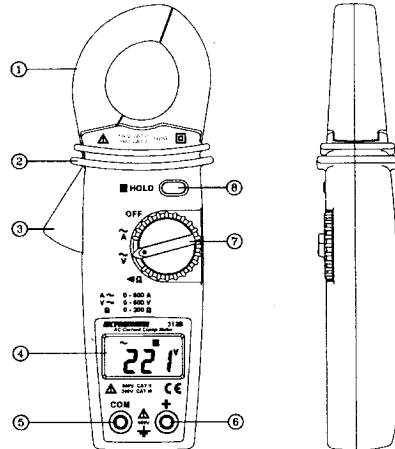
III. Instrument Familiarization:**Symbol Definition:****Instrument Familiarization:**

- ① Current Sensing Clamp
- ② Safety protection ring
- ③ Clamp opening handle
- ④ LCD display
- ⑤ COM input terminal
- ⑥ Positive input terminal
- ⑦ Function select dial
- ⑧ Data hold button

IV. Measuring Instruction:

4.1 ACA measurement:

Switch the function selector to A~ range.

Open the clamp by pressing the jaw-opening handle and insert the cable to be measured into the jaw.

Close the clamp and get the reading from the LCD panel.

Note:

Before this measurement, disconnect the test lead with the meter for safety.

In some occasion that the reading is hard to read, push the HOLD button and read the result later.

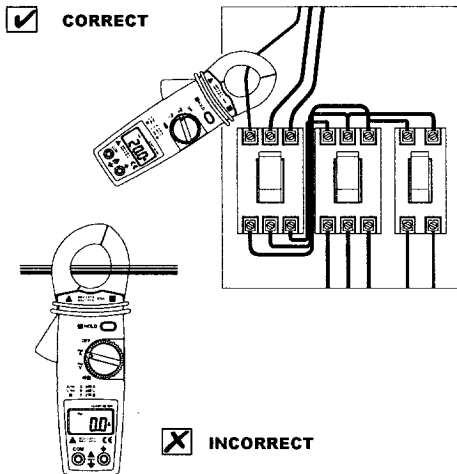

5

4.2 ACV measurement:

Switch the function selector to V~ range.

Connect red test lead to "+" terminal and black one to the "COM" terminal.

Measure the voltage by touch the test lead tips to the test circuit where the value of voltage is needed.

Read the result from the LCD panel.

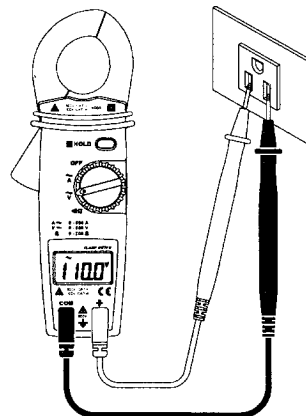

6

4.3 Resistance measurement:

Switch the function selector to Ω range.

Connect red test lead to "+" terminal and black one to the "COM" terminal.

Connect tip of the test leads to the points where the value of the resistance is needed.

Read the result from the LCD panel.

Note:

When take resistance value from a circuit system, make sure the power is cut off and all capacitors need to be discharged.

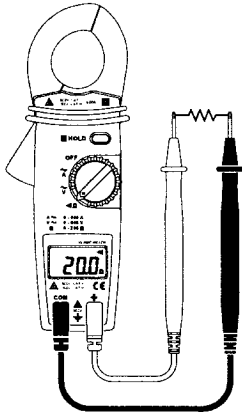

7

4.4 Continuity Test:

Switch the function selector to Ω range.

Connect red test lead to "+" terminal and black one to the "COM" terminal.

Connect tip of the test leads to the points where the conducting condition needed.

If the resistance is under 100Ω , the beeper will sound continuously.

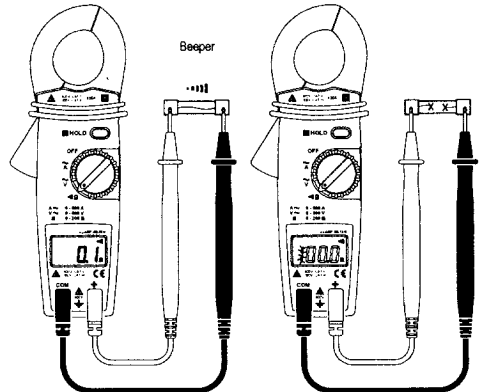

8

V. Battery Changing:

1. When the battery voltage drops below proper operation range the  symbol will appear on the LCD display and the battery needs to be changed.
2. Before changing the battery, switch the function selector to "OFF" and disconnect test leads.
Open the back cover by a screwdriver. Replace the old batteries with two UM-4 or AAA size batteries.
3. Close the back cover and fasten the screw.

VI. Maintenance:**CAUTION**

To avoid contamination or static damage, do not touch the circuit board without proper static protection.

REMARK

- * If the meter is not going to be used for a long time, take out the battery and do not store the meter in high temperature or high humidity environment.
- * When making current measurement, keep the cable at the center of the clamp to get more accurate reading.

CLEANING

Periodically wipe the case with a dry cloth and without detergent. Do not use abrasives or solvents on this instrument.

Warranty Service: Please return the product in the original packaging with proof of purchase to the below address. Clearly state in writing the performance problem and return any leads, connectors and accessories that you are using with the device.

Non-Warranty Service: Return the product in the original packaging to the below address. Clearly state in writing the performance problem and return any leads, connectors and accessories that you are using with the device. Customers not on open account must include payment in the form of a money order or credit card. For the most current repair charges contact the factory before shipping the product.

Return all merchandise to B&K Precision Corp. with pre-paid shipping. The flat-rate repair charge includes return shipping to locations in North America. For overnight shipments and non-North America shipping fees contact B&K Precision Corp..

B&K Precision Corp.
22820 Savi Ranch Parkway
Yorba Linda, CA. 92887
Phone: 714- 921-9095
Facsimile: 714-921-6422
Email: service@bkprecision.com

Include with the instrument your complete return shipping address, contact name, phone number and description of problem.

Limited one-Year Warranty

B&K Precision Corp. warrants to the original purchaser that its product and the component parts thereof, will be free from defects in workmanship and materials for a period of one years from the data of purchase.

B&K Precision Corp. will, without charge, repair or replace, at its' option, defective product or component parts. Returned product must be accompanied by proof of the purchase date in the form a sales receipt.

To obtain warrandy coverage in the U.S.A., this product must be registered by completing and mailing the enclosed warranty card to B&K Precision Corp., 22820 Savi Ranch Parkway, Yorba Linda, CA 92887 within fifteen (15) days from proof of purchase.

Exclusions:

This warranty does not apply in the event of misuse or abuse of the product or as a result of unauthorized alternations or repairs. It is void if the serial number is alternated, defaced or removed.

B&K Precision Corp. shall not be liable for any consequential damages, including without limitation damages resulting from loss of use. Some states do not allow limitation of incidental or consequential damages, so the above limitation or exclusion may not apply to you.

This warranty gives you specific rights and you may have other rights, which vary from state-to-state.

Model Number: _____ Date Purchased: _____