

SACB- 6/3-L-10,0PUR-M8

Order No.: 1516043

<http://eshop.phoenixcontact.de/phoenix/treeViewClick.do?UID=1516043>

Sensor/actuator box, M8 socket, Number of slots: 6, Number of positions: 3, Slot assignment: Single, Status indication: Yes, pnp 180°, PUR/PVC, Cable length: 10 m, Shielding: No

Commercial data	
GTIN (EAN)	 4 017918 967024
sales group	D102
Pack	1 pcs.
Customs tariff	85366990
Catalog page information	Page 112 (PC-2009)

Product notes

WEEE/RoHS-compliant since:
03/13/2006

<http://www.download.phoenixcontact.com>
Please note that the data given here has been taken from the online catalog. For comprehensive information and data, please refer to the user documentation. The General Terms and Conditions of Use apply to Internet downloads.

Technical data	
General data	
Rated voltage	24 V DC
Max. operating voltage U_{max}	30 V DC
Current carrying capacity per I/O signal	2 A
Current carrying capacity per slot	2 A

Total rated current	6 A
Number of positions	3
Number of slots	6
Degree of protection	IP65/IP67
Inflammability class acc. to UL 94	V0
Ambient temperature (operation)	-30 °C ... 80 °C
Sensor/actuator connection system	M8 socket

Local diagnostics function

Local diagnostics	Supply voltage Green LED
	Status display I/O Yellow LED

Master cable data

Type of connection	Fixed connection
Length of cable	10 m
Cable type	Master cable suitable for flexible cable conduit
Signal line cross section	6x 0.34 mm ²
AWG signal line	22
Conductor structure signal line	42x 0.10 mm
Power supply cross section	2x 0.75 mm ²
AWG power supply	18
Conductor structure, voltage supply	96x 0.10 mm
External diameter	8.2 mm
Max. bending cycles	1500000
Bending radius	85 mm
Traversing path	2 m
Traversing rate	2 m/s
Ambient temperature (operation)	-40 °C ... 90 °C (for fixed installation)
	-5 °C ... 80 °C (for flexible installation)
Tightening torque slot sensor/actuator cable	0.2 Nm
Tightening torque screw plug	0.2 Nm

Insulation material

Housing material	PBT
Material of the moulding mass	PUR
Contact material	CuSn
Contact surface material	Ni/Au

Contact carrier material	PA
Material of threaded sleeve	Cu alloy
Material of threaded sleeve surface	Nickel-plated
Material, O-ring	NBR

Pin assignment

Slot/position = Wire color or connection	1 / 4 (A) = WH
	2 / 4 (A) = GN
	3 / 4 (A) = YE
	4 / 4 (A) = GY
	5 / 4 (A) = PK
	6 / 4 (A) = RD
	1-6 / 1 (+ 24 V) = BN
	1-6 / 3 (0 V) = BU

Certificates / Approvals



Certification CUL, UL

Accessories

Item	Designation	Description
Marking		
0809984	ZBF10:SO/CMS	Zack marker strip, flat, in 10 mm pitch, labeled according to customer specifications, 10-section, divisible, color: White
0809997	ZBF10:UNBEDRUCKT	Zack marker strip, flat, in 10 mm pitch, unprinted, 10-section, for individual labeling with M-PEN 0,8, X-PEN, or CMS-P1-PLOTTER

Protection and sealing elements

1682540	PROT-M8	An M8 screw plug for the unoccupied M8 sockets of the sensor/ actuator cable, boxes and flush-type connectors
---------	---------	---

Tools

1208461	SAC BIT M8-D10	Nut for assembling sensor/actuator cables with M8 connector and for M8 connectors with QUICKON fast connection technology, for 4 mm hexagonal drive
1208474	SACC BIT M8-D12	Nut for assembling SACC M8 connectors for free assembly with longitudinal knurl, excluding M8 connectors with QUICKON fast connection technology, for 4 mm hexagonal drive
1208487	TSD 02 SAC	Torque screwdriver, with preset torque of 0.2 Nm and 4 mm hexagonal drive for M8 connectors

Diagrams/Drawings

Dimensioned drawing

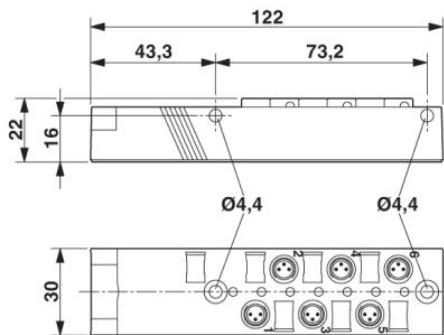

Circuit diagram

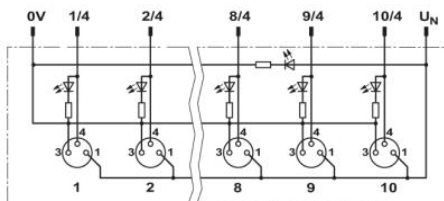

Schematic diagram

M8 slot, socket, 3-pos.

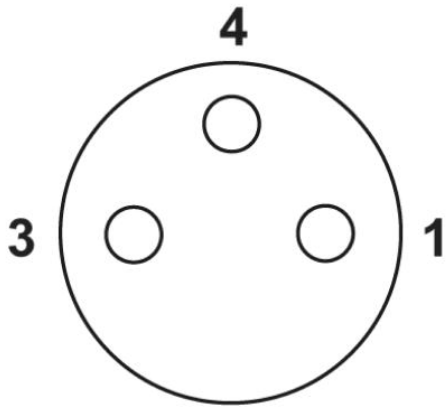

Address

PHOENIX CONTACT Deutschland GmbH
Flachmarktstr. 8
32825 Blomberg, Germany
Phone +49 5235 3 12000
Fax +49 5235 3 41200
<http://www.phoenixcontact.de>



© 2010 Phoenix Contact
Technical modifications reserved;