

MOLLY-M

~35° medium beam

TECHNICAL SPECIFICATIONS:

Dimensions	Ø 69.8 mm
Height	23.6 mm
Fastening	
Colour	clear
Box size	476 x 273 x 292 mm
Box weight	9 kg
Quantity in Box	198 pcs
ROHS compliant	yes ⓘ



MATERIAL SPECIFICATIONS:

Component	Type	Material	Colour
MOLLY-M	Lens	PMMA	clear

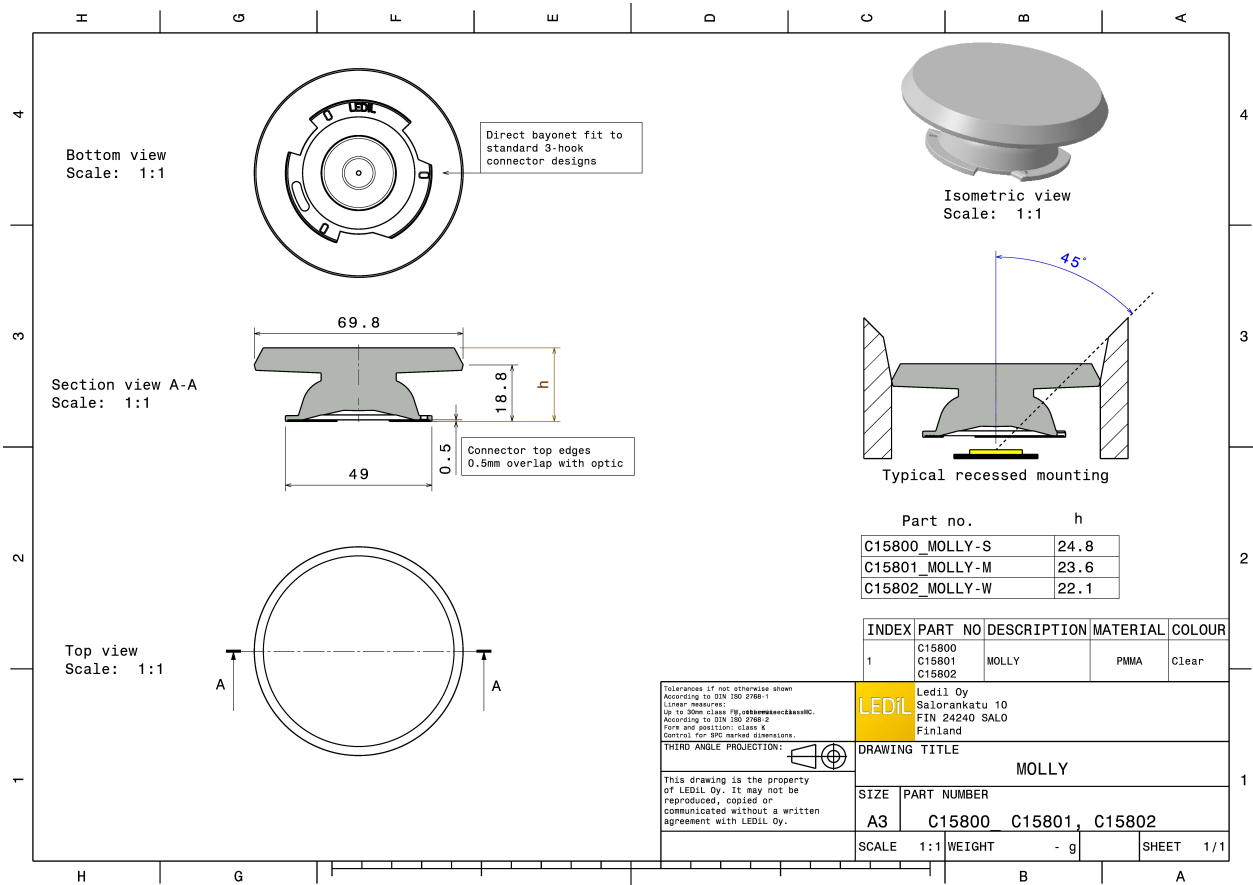

PHOTOMETRIC DATA (MEASURED):

bridgelux

LED Vero SE 13
FWHM 36.0°
Efficiency 90 %
Peak intensity 2.100 cd/lm
Required components:
C16402_CLAMP-VEROSE-13-18

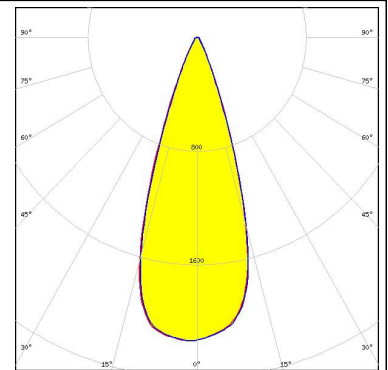

bridgelux

LED Vero SE 18
FWHM 40.0°
Efficiency 89 %
Peak intensity 1.700 cd/lm
Required components:
C16402_CLAMP-VEROSE-13-18

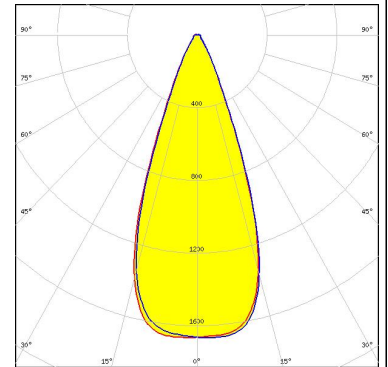
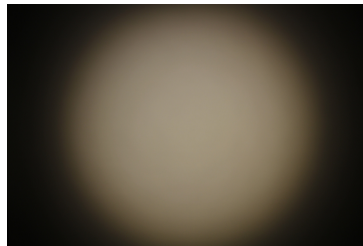

CITIZEN

LED CLL03x/CLU03x
FWHM 36.0°
Efficiency 89 %
Peak intensity 2.060 cd/lm
Required components:
Bender Wirth: 433 Typ L1

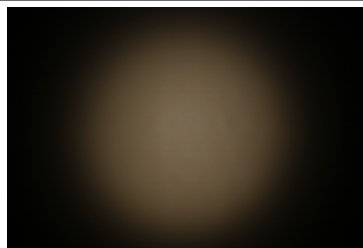

CREE

LED CMA1840
FWHM 37.0°
Efficiency 91 %
Peak intensity 2.000 cd/lm
Required components:
C14123_CLAMP-CXA15-18

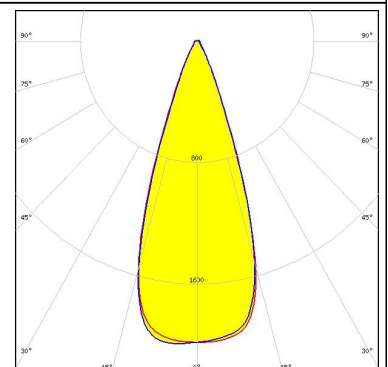
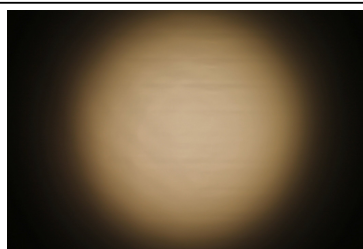

PHOTOMETRIC DATA (MEASURED):



LED CMA2550
 FWHM 42.0°
 Efficiency 89 %
 Peak intensity 1.600 cd/lm
 Required components:
 C14036_CLAMP_CXA25-30

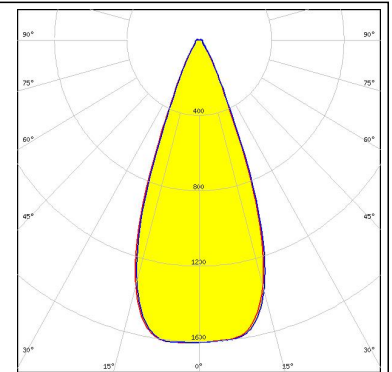
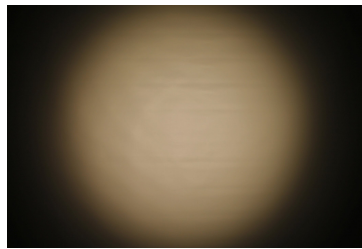

LED CMA3090
 FWHM 45.0°
 Efficiency 88 %
 Peak intensity 1.400 cd/lm
 Required components:
 C14036_CLAMP_CXA25-30

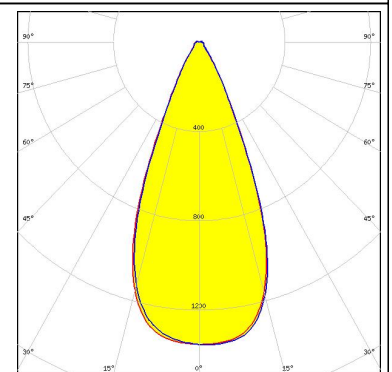
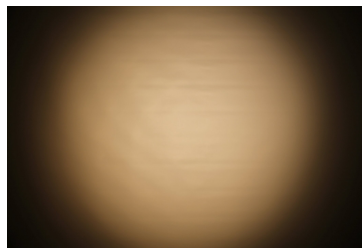

LED CDM-14 (Dim-To-Warm)
 FWHM 36.0°
 Efficiency 89 %
 Peak intensity 2.000 cd/lm
 Required components:
 C13658_CLAMP-VERO13-18
 Bender Wirth: 491 Typ L2

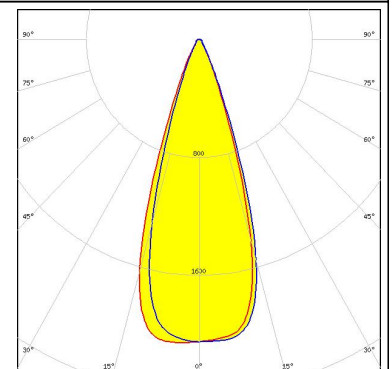
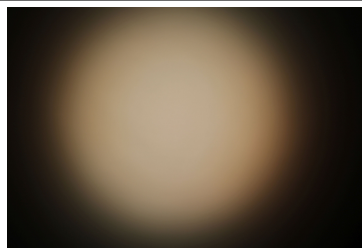

LED CDM-18 (Dim-To-Warm)
 FWHM 38.0°
 Efficiency 89 %
 Peak intensity 1.900 cd/lm
 Required components:
 C13658_CLAMP-VERO13-18
 Bender Wirth: 491 Typ L2

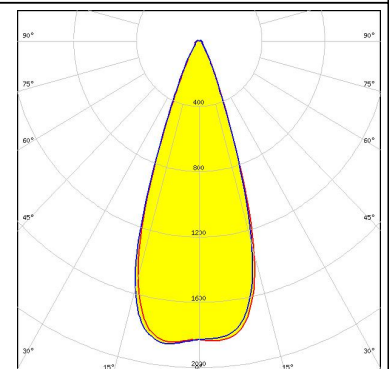
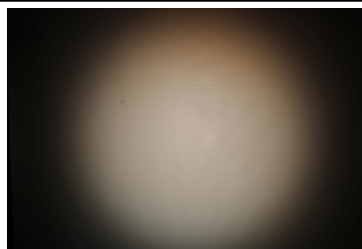

PHOTOMETRIC DATA (MEASURED):



LED CDM-9 (Dim-To-Warm)
 FWHM 33.0°
 Efficiency 89 %
 Peak intensity 2.400 cd/lm
 Required components:
 C13658_CLAMP-VERO13-18
 Bender Wirth: 490 Typ L1

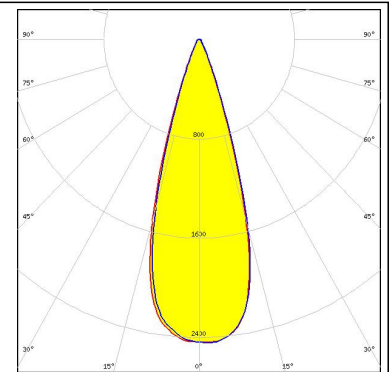
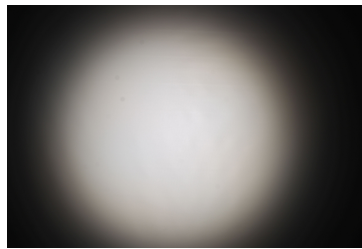

LED CTM-14 (Tunable White)
 FWHM 34.0°
 Efficiency 88 %
 Peak intensity 2.200 cd/lm
 Required components:
 C13584_CLAMP-VERO29
 Bender Wirth: 442 Typ L3

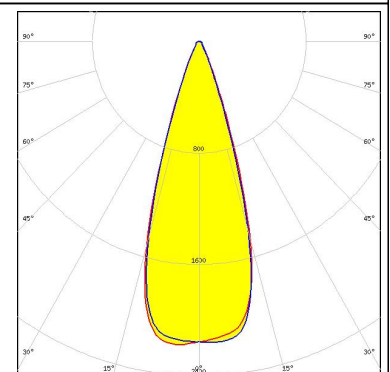
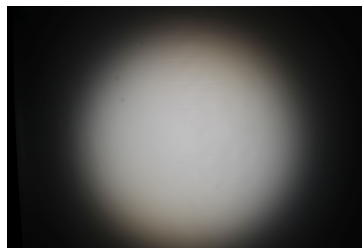

LED CTM-22 (Tunable White)
 FWHM 42.0°
 Efficiency 87 %
 Peak intensity 1.500 cd/lm
 Required components:
 C13584_CLAMP-VERO29
 Bender Wirth: 494 Typ L3

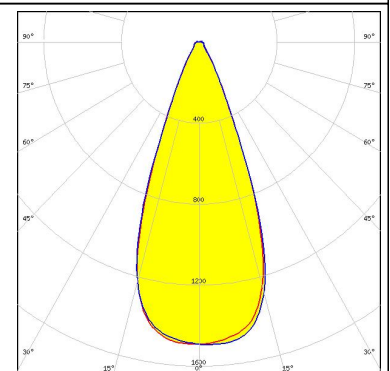
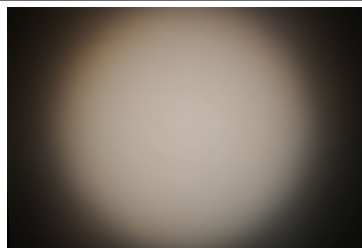

LED Fortimo SLM L15 Standard
 FWHM 34.0°
 Efficiency 89 %
 Peak intensity 2.300 cd/lm
 Required components:
 TE: OPTIC CLIP Z50 TYPE1 2213194-1

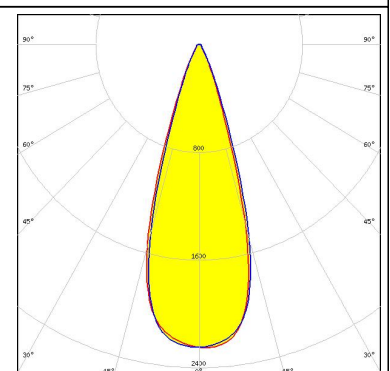
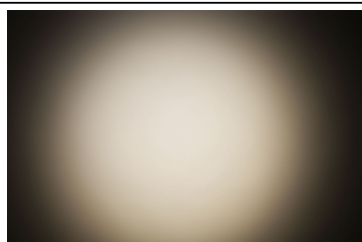

PHOTOMETRIC DATA (MEASURED):

XICATO

LED XIM - 19mm LES

FWHM 39.0°

Efficiency 90 %

Peak intensity 1.800 cd/lm

Required components:

C16491_XTM-ADAPTER-50-A

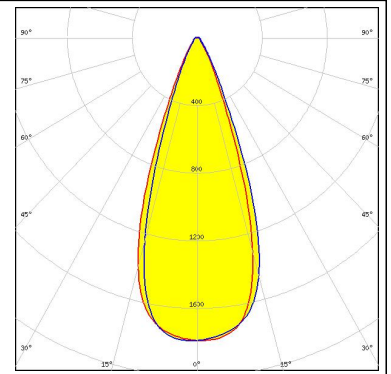

PHOTOMETRIC DATA (SIMULATED):



LED VERO13
 FWHM 32.0°
 Efficiency 91 %
 Peak intensity 3.100 cd/lm
 Required components:
 C13658_CLAMP-VERO13-18

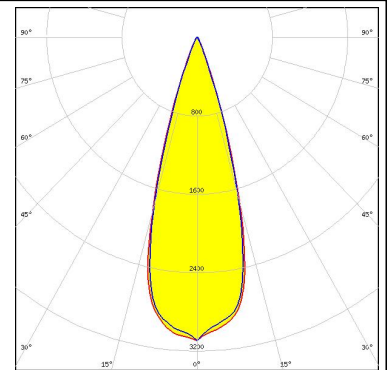

CITIZEN

LED CLL02x/CLU02x (LES10)
 FWHM 30.0°
 Efficiency 89 %
 Peak intensity 3.600 cd/lm
 Required components:
 Bender Wirth: 434 Typ L1

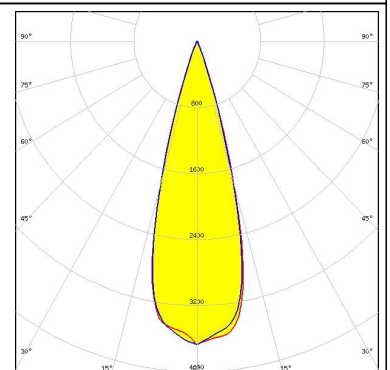

LED CXA/B 1816 & CXA/B 1820 & CXA 1850
 FWHM 33.0°
 Efficiency 90 %
 Peak intensity 3.070 cd/lm
 Required components:
 LEDiL: C14123_CLAMP-CXA15-18

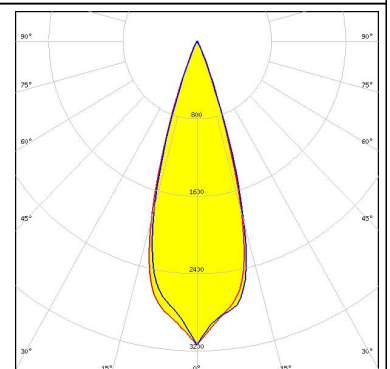

LED CXA/B 25xx
 FWHM 36.0°
 Efficiency 88 %
 Peak intensity 2.200 cd/lm
 Required components:
 LEDiL: C14036_CLAMP-CXA25-30

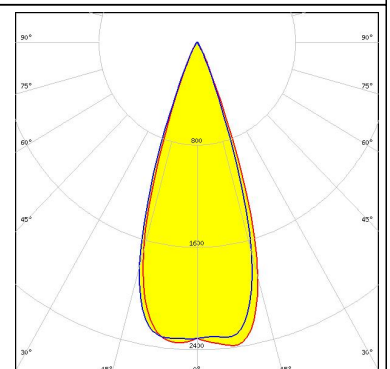

PHOTOMETRIC DATA (SIMULATED):

TRIDONIC

LED SLE G6 LES15 H D50
FWHM 30.0°
Efficiency 85 %
Peak intensity 0.000 cd/lm
Required components:
TE: OPTIC CLIP Z50 TYPE1 2213194-1

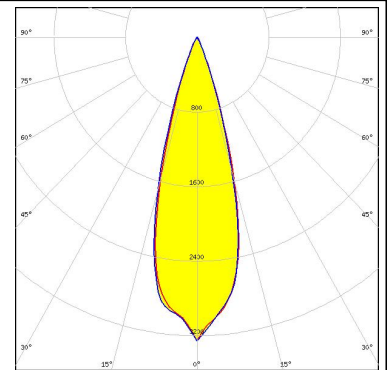

TRIDONIC

LED SLE G6 LES17 H
FWHM 32.0°
Efficiency 87 %
Peak intensity 2.900 cd/lm
Required components:
TE: OPTIC CLIP Z50 TYPE1 2213194-1

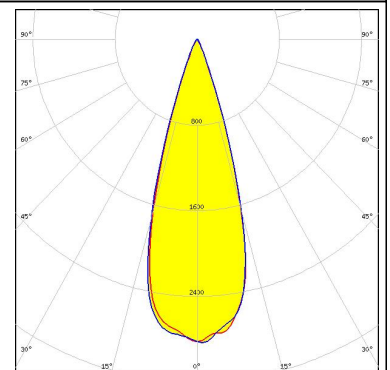

TRIDONIC

LED SLE G6 LES19 H
FWHM 34.0°
Efficiency 85 %
Peak intensity 2.600 cd/lm
Required components:
TE: OPTIC CLIP Z50 TYPE1 2213194-1

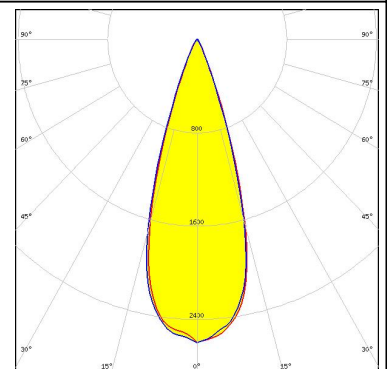

GENERAL INFORMATION:

NOTE: The typical beam angle will be changed by different color, chip size and chip position tolerance. The typical total beam angle is the full angle measured where the luminous intensity is half of the peak value.

Due to use of high power COB's with this product, special attention to proper thermal design is highly recommended. LEDiL has no liability for direct, indirect or consecutive damages arising from the LEDiL products being used outside of the recommended temperature range.

MATERIALS:

As part of our continuous research and improvement processes, and to ensure the best possible quality and availability of our products, LEDiL reserves the right to change material grades without notice.

PRODUCT DATA USER AGREEMENT AND DISCLAIMER:

The measured data in the provided downloadable LEDiL Product Datasheets and Mechanical 2D-Drawings is rounded and provided as reference for planning. LEDiL Oy's optical specifications have been verified by conducting performance testing of the products in accordance with the company's quality system. The reported data are averaged results of multiple measurements with typical variation. LEDiL Oy reserves the right to without prior notification make changes and improvements to its products.

LEDiL Oy assumes neither warranty, nor guarantee nor any other liability of any kind for the contents and correctness of the provided data. The provided data has been generated with highest diligence but the provided data may in reality not represent the complete possible variation range of all intrinsic parameters. Therefore, in certain cases a deviation from the provided data could occur.

LEDiL Oy reserves the right to undertake technical changes of its products without further notification which could lead to changes in the provided data. LEDiL Oy assumes no liability of any kind for the possible deviation from any provided data or any other damage resulting from the usage of the provided data.

The user agrees to this disclaimer and user agreement with the download or usage of the provided files.

LEDiL Oy

Joensuunkatu 13
FI-24240 SALO
Finland

LEDiL Inc.

228 West Page Street
Suite D
Sycamore IL 60178
USA

Local sales and technical support

[www.ledil.com/
where_to_buy](http://www.ledil.com/where_to_buy)

Shipping locations

Salo, Finland
Hong Kong, China

Distribution Partners

[www.ledil.com/
where_to_buy](http://www.ledil.com/where_to_buy)