

Evaluation Board for the Integer-N and Fractional-N PLL Frequency Synthesizer

FEATURES

- General-purpose PLL evaluation board, excluding the frequency synthesizer, VCO, and loop filter
- Compatible with integer-N PLLs in a 16-lead TSSOP package
[ADF4110](#), [ADF4111](#), [ADF4112](#), [ADF4113](#), [ADF4116](#), [ADF4117](#), [ADF4118](#), [ADF4106](#), [ADF4107](#)
- Compatible with fractional-N PLLs in a 16-lead TSSOP package
[ADF4153](#), [ADF4154](#), [ADF4156](#), [ADF4157](#)
- Accompanying software allows complete control of synthesizer functions from a PC

EVALUATION KIT CONTENTS

- EV-ADF411XSD1Z board
- CD that includes
 - Self-installing software that allows users to control the board and exercise all functions of the device
 - Electronic version of the frequency synthesizer data sheet
 - Electronic version of the [UG-161](#) user guide

ADDITIONAL EQUIPMENT

- PC running Windows XP or more recent version
- [SDP-S](#) board (system demonstration platform-serial)
- ADF41XXBRUZ (see the Features section for applicable parts)
- T-package VCO, loop filter components
- Spectrum analyzer, oscilloscope (optional)

DOCUMENTS NEEDED

- Frequency synthesizer data sheet
- [UG-161](#) user guide

REQUIRED SOFTWARE

- Analog Devices Int-N PLL software (Version 7 or higher)
- Analog Devices Frac-N PLL software (Version 4 or higher)
- [ADIsimPLL](#)

GENERAL DESCRIPTION

This evaluation board allows the user to evaluate the performance of the ADF41XXBRUZ frequency synthesizers, which are available in 16-lead TSSOP packages. The [SDP-S](#) controller board allows software programming of the frequency synthesizer. Figure 1 shows the board, which contains footprints for a frequency synthesizer, the power supplies, a TCXO reference, and an RF output. There are also footprints for the passive PLL loop filter components, a VCO, and an external reference SMA input.

The PLL loop filter values can be generated from the Analog Devices, Inc., [ADIsimPLL](#) software tool. Prior to evaluation setup, the ADF41XXBRUZ, T-package VCO, and loop filter components should be inserted on the board.

Figure 1 shows the board with all necessary components inserted.

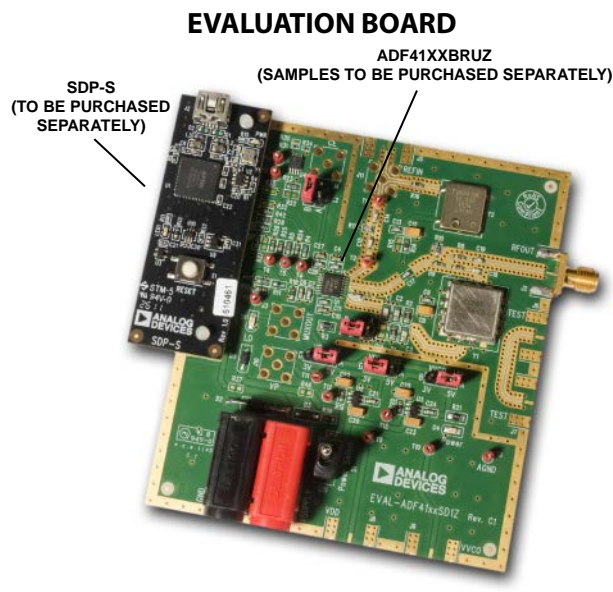

Figure 1. EV-ADF411XSD1Z with [SDP-S](#)

TABLE OF CONTENTS

Features	1	Default Operation and Jumper Selection Settings.....	5
Evaluation Kit Contents.....	1	System Demonstration Platform (SDP)	5
Additional Equipment	1	Evaluation Board Setup Procedure	6
Documents Needed.....	1	Installing the Int-N PLL Software	6
Required Software	1	Installing the Frac-N PLL Software	10
General Description	1	Evaluation Board Software	14
Evaluation Board	1	Int-N PLL Software	14
Revision History	2	Frac-N PLL Software	16
Quick Start Guide.....	3	Evaluation and Test	18
Evaluation Board Hardware	4	Evaluation Board Schematics and Artwork.....	19
Power Supplies	4	Bill of Materials.....	26
Input Signals.....	4	Related Links.....	27
Output Signals.....	4		

REVISION HISTORY

6/12—Rev. 0 to Rev. A

Changed EVAL-ADF411XEBZ1 to EV-ADF411XSD1Z.... Universal
 Replaced All Sections, Tables, and Figures Universal

8/11—Revision 0: Initial Version

QUICK START GUIDE

Follow these steps to evaluate the frequency synthesizer ([ADF4110](#), [ADF4111](#), [ADF4112](#), [ADF4113](#), [ADF4116](#), [ADF4117](#), [ADF4118](#), [ADF4106](#), [ADF4107](#), [ADF4153](#), [ADF4154](#), [ADF4156](#), or [ADF4157](#)) after inserting all necessary components on the board and ensuring that the on-board links are correct with reference to Table 1:

1. Install the system development platform (SDP) drivers.
2. Install the Int-N or Frac-N PLL software.
3. Connect the [SDP-S](#) motherboard to the PC and to the EV-ADF411XSD1Z.
4. Connect the power supplies to banana connectors (6 V to 12 V).
5. Run the Int-N or Frac-N PLL software.
6. Select the SDP board and the frequency synthesizer in the **Select Device and Connection** tab of the main window.
7. Click the **Main Controls** tab, and then update all registers.
8. Connect the spectrum analyzer to J2.
9. Measure the results.

EVALUATION BOARD HARDWARE

The evaluation board requires the use of an [SDP-S](#) motherboard to program the device. The [SDP-S](#) is not included with the evaluation board. The EV-ADF411XSD1Z schematics are shown in Figure 37, Figure 38, and Figure 39.

POWER SUPPLIES

The board is powered from external banana connectors. The voltage can vary between 6 V and 12 V. The power supply circuit provides 3.0 V to the V_{DD} of the frequency synthesizer and allows the user to choose either 3.0 V or 5 V for the V_P of the frequency synthesizer. The default settings for V_{DD} and V_P are 3.0 V and 5 V, respectively. Note that V_{DD} should never exceed 3.3 V because exceeding this voltage level may damage the device.

External power supplies can be used to directly drive the frequency synthesizer. In this case, the user must insert SMA connectors as shown in Figure 2.

INPUT SIGNALS

A 10 MHz TCXO reference source from Fox Electronics is fitted as the default option. An external reference generator can also be used as the reference input. A low noise, high slew rate reference source is required to achieve the specified performance of the frequency synthesizer. An SMA connector fitted to J11 can be connected to an external reference generator and used as the reference source. If preferable, the edge mount connector, J5, can be inserted and used instead of J11. To use any external reference option, remove the $0\ \Omega$ R16 and R14 links.

Digital SPI signals are supplied through the SDP connector, J1. The [SDP-S](#) board is recommended. The [SDP-Blackfin \(SDP-B\)](#) board can also be used, but Resistor R57 must be removed from the [SDP-B](#) board. Some additional spurious low frequencies may appear if the [SDP-B](#) connector is used.

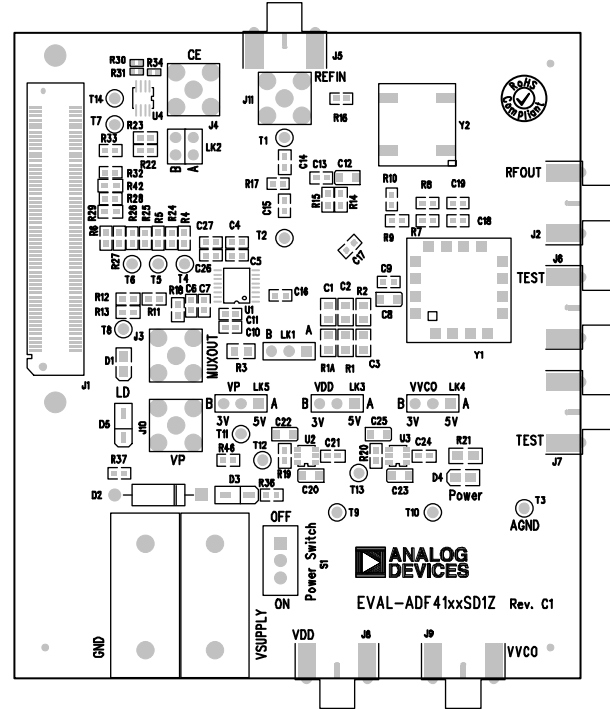

Figure 2. Evaluation Board Silkscreen

OUTPUT SIGNALS

The PLL comprises the frequency synthesizer, a passive loop filter, and the VCO. The VCO output is available at RFOUT through a standard SMA connector, J2. The MUXOUT signal can be monitored at Test Point T8 or at SMA Connector J3.

DEFAULT OPERATION AND JUMPER SELECTION SETTINGS

Link positions and their respective functions are outlined in Table 1.

Table 1. Link Positions and Functions

Link	Position	Options	Description
LK1	A	R1A	Not used
	B	RSET	Normal operation
LK2	A	GND	Hardware power-down
	B	VDD	Normal operation
LK3 (V _{DD})	A	5 V	Not used
	B	3 V	Normal operation
LK4 (V _{VCO})	A	5 V	VCO supply (5 V)
	B	3 V	VCO supply (3 V)
LK5 (V _P)	A	5 V	V _P supply (5 V)
	B	3 V	V _P supply (3 V)

SYSTEM DEMONSTRATION PLATFORM (SDP)

The system demonstration platform (SDP) is a series of controller boards, interposer boards, and daughter boards that can be used for easy, low cost evaluation of Analog Devices components and reference circuits. It is a reusable platform whereby a single controller board can be reused in various daughter board evaluation systems.

Controller boards connect to the PC via a USB 2.0 high speed port and provide a range of communication interfaces on a 120-pin connector. The pinout for this connector is strictly defined. A receptacle for this 120-pin connector is included on all SDP daughter boards, component evaluation boards, and Circuits from the Lab® reference circuit boards. There are two controller boards in the platform: the [SDP-B](#), which is based on the Blackfin® [ADSP-BF527](#), and the [SDP-S](#), which is a serial interface only controller board. The [SDP-S](#) has a subset of the [SDP-B](#) functionality.

Interposer boards route signals between the SDP 120-pin connector and a second connector. When the second connector is also a 120-pin connector, the interposer can be used for signal monitoring of the 120-pin connector signals. Alternatively, the second connector allows SDP platform elements to be integrated into a second platform, for example, the BeMicro SDK. More information on the SDP can be found at www.analog.com/sdp.

EVALUATION BOARD SETUP PROCEDURE

INSTALLING THE INT-N PLL SOFTWARE

Use the following steps to install the SDP drivers and the Analog Devices Int-N PLL software:

1. Install the Int-N PLL software by double-clicking **ADI_Int-N_Setup.msi**.
 If you are using Windows XP, follow the instructions in the Windows XP Int-N PLL Software Installation Guide section (see Figure 3 to Figure 7).
 If you are using Windows Vista or Windows 7, follow the instructions in the Windows Vista and Windows 7 Int-N PLL Software Installation Guide section (see Figure 8 to Figure 12).
 Note that the Int-N PLL software requires Microsoft Windows Installer and Microsoft .NET Framework 3.5 (or higher). The installer connects to the Internet and downloads Microsoft .NET Framework automatically. Alternatively, before running **ADI_Int-N_Setup.msi**, both the installer and .NET Framework can be installed from the CD provided in the evaluation board kit.
2. Connect the SDP board (black) to a PC using the supplied USB cable.
 If you are using Windows XP, follow the steps in the Windows XP SDP-S Board Driver Installation Guide section (see Figure 13 to Figure 16).
 If you are using Windows Vista or Windows 7, the drivers install automatically.

Windows XP Int-N PLL Software Installation Guide

1. Click **Next**.

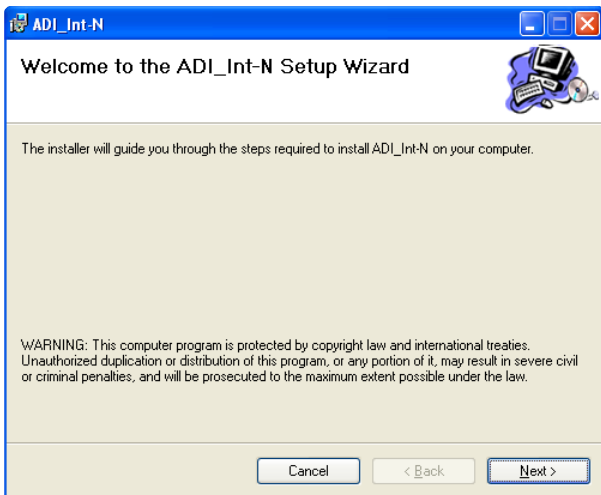

Figure 3. Windows XP Int-N PLL Software Installation, Setup Wizard

2. Choose an installation directory, and then click **Next**.

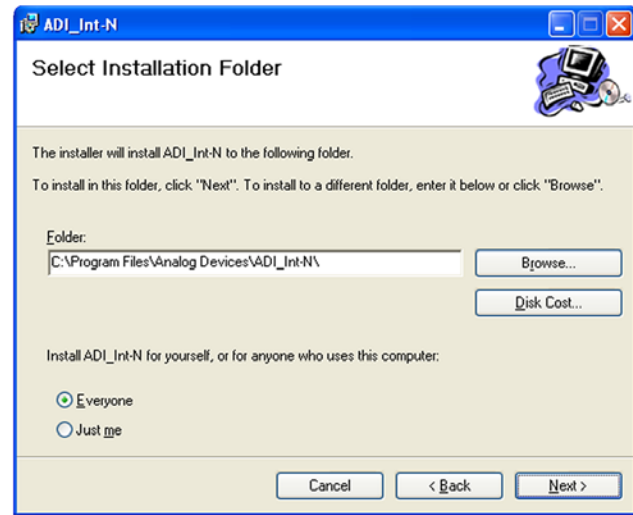

Figure 4. Windows XP Int-N PLL Software Installation, Select Installation Folder

3. Click **Next**.

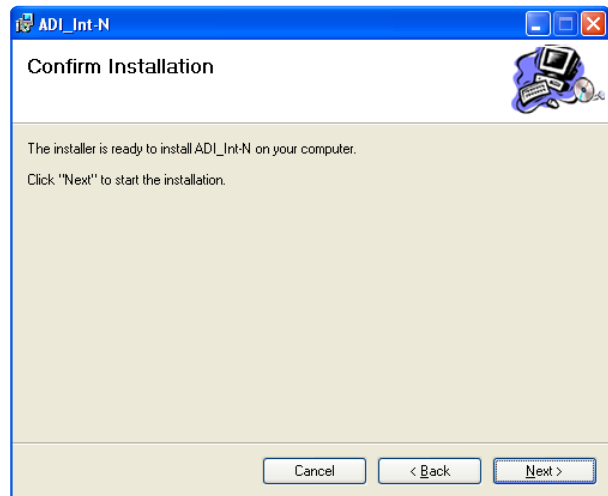

Figure 5. Windows XP Int-N PLL Software Installation, Confirm Installation

- Click **Continue Anyway**.

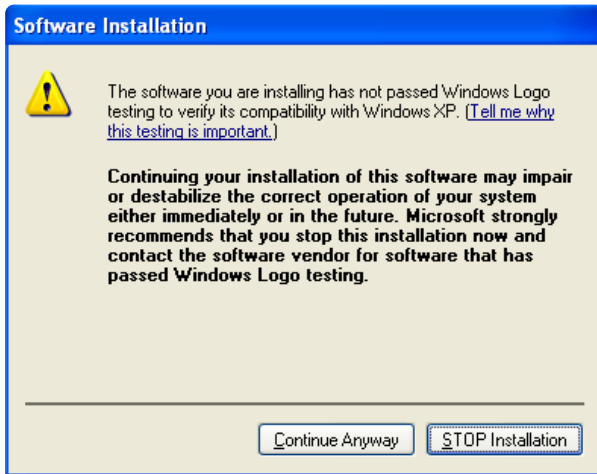

Figure 6. Windows XP Int-N PLL Software Installation, Logo Testing

- Click **Close**.

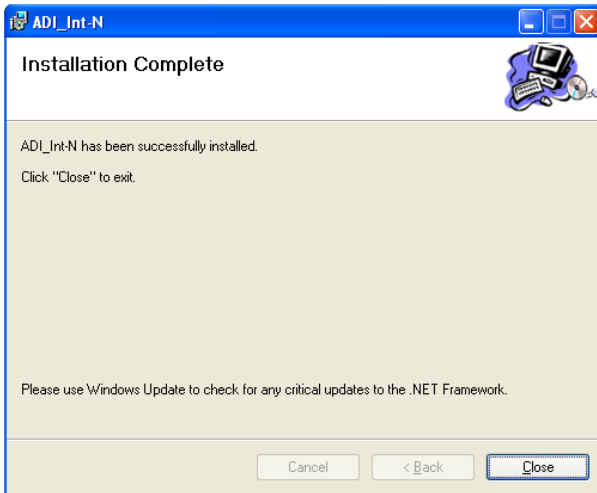

Figure 7. Windows XP Int-N PLL Software Installation, Installation Complete

Windows Vista and Windows 7 Int-N PLL Software Installation Guide

- Click **Next**.



Figure 8. Windows Vista/Windows 7 Int-N PLL Software Installation, Setup Wizard

- Choose an installation directory, and then click **Next**.

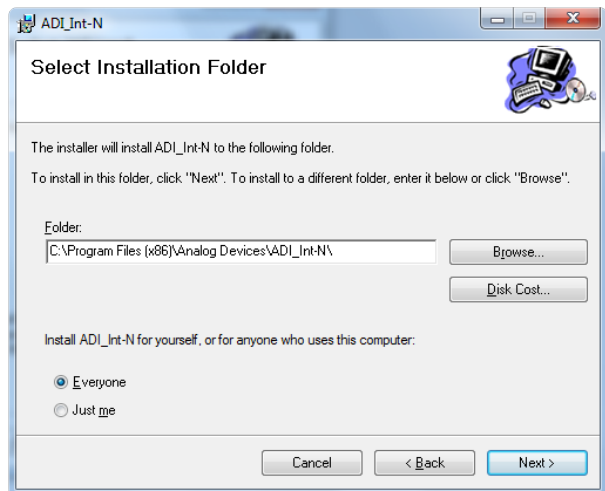
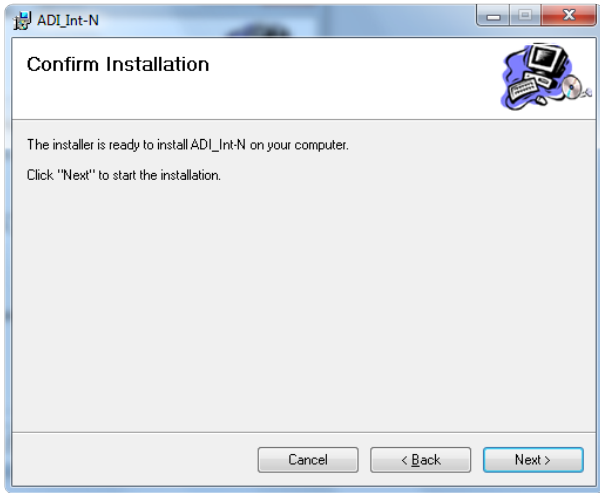

Figure 9. Windows Vista/Windows 7 Int-N PLL Software Installation, Select Installation Folder

3. Click **Next**.



09146-010

Figure 10. Windows Vista/Windows 7 Int-N PLL Software Installation, Confirm Installation

5. Click **Close**.

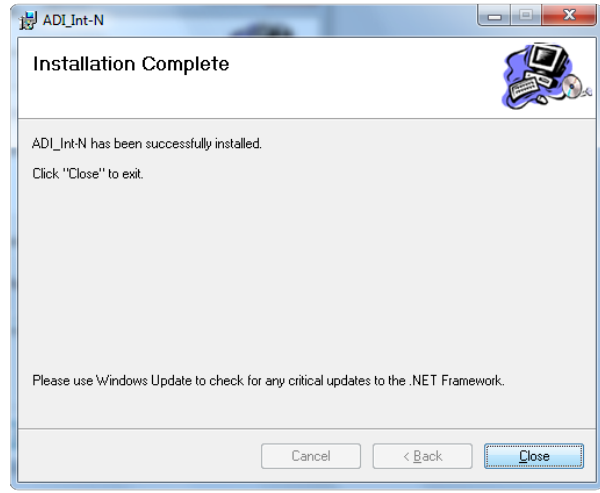

09146-012

Figure 12. Windows Vista/Windows 7 Int-N PLL Software Installation, Installation Complete

4. Click **Install**.

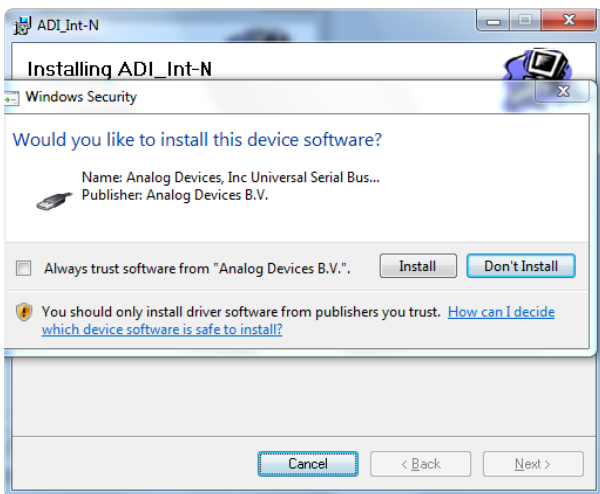

09146-011

Figure 11. Windows Vista/Windows 7 Int-N PLL Software Installation, Start Installation

Windows XP SDP-S Board Driver Installation Guide

1. Choose **Yes, this time only**, and then click **Next**.

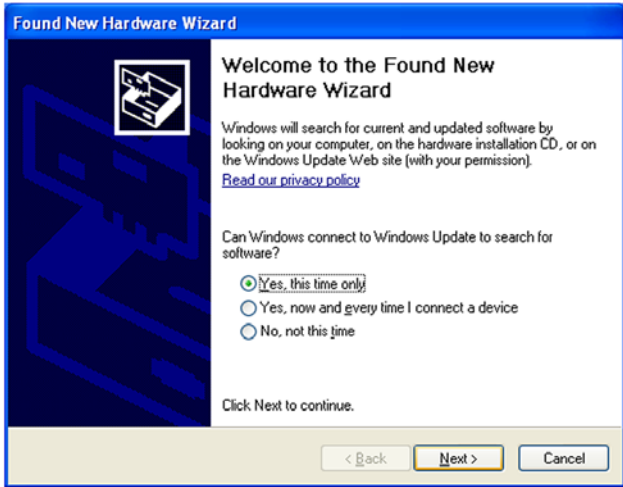

Figure 13. Windows XP SDP-S Board Driver Installation, Found New Hardware Wizard

2. Click **Next**.

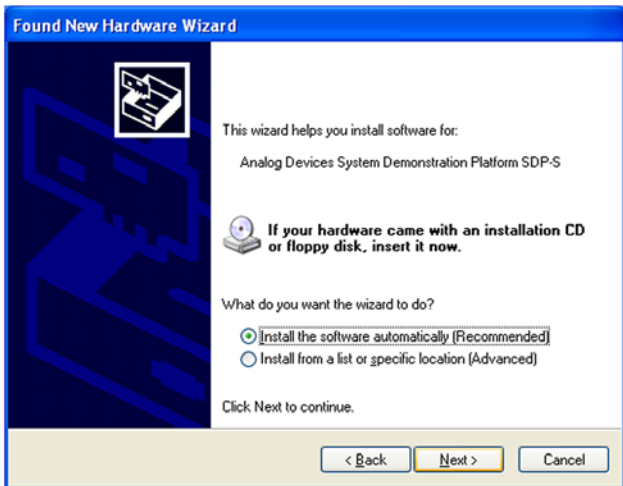

Figure 14. Windows XP SDP-S Board Driver Installation, Installation Options

3. Wait for the installation program to copy all the necessary files.

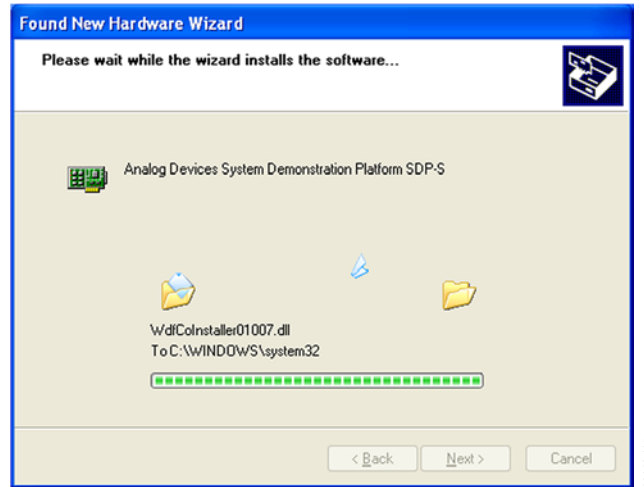

Figure 15. Windows XP SDP-S Board Driver Installation, Progress

4. Click **Finish**.

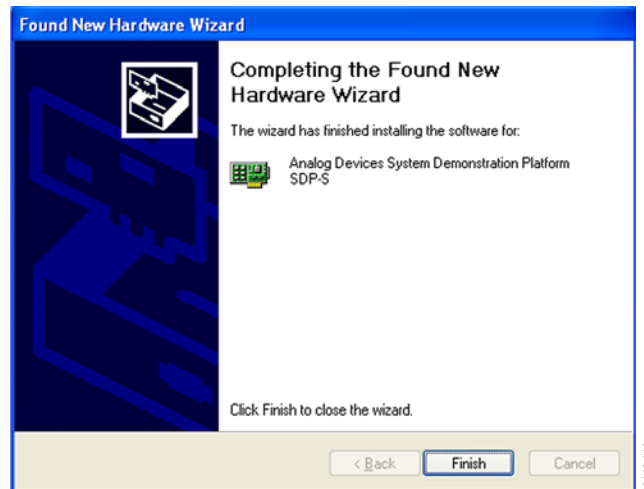

Figure 16. Windows XP SDP-S Board Driver Installation, Complete Installation

INSTALLING THE FRAC-N PLL SOFTWARE

Use the following steps to install the SDP drivers and the Analog Devices Frac-N PLL software.

1. Install the Frac-N PLL software by double-clicking **ADI_PLL_Frac-N_Setup.msi**.
 If you are using Windows XP, follow the instructions in the Windows XP Int-N PLL Software Installation Guide section (see Figure 17 to Figure 21).
 If you are using Windows Vista or Windows 7, follow the instructions in the Windows Vista and Windows 7 Frac-N PLL Software Installation Guide section (see Figure 22 to Figure 26).
 Note that the software requires Microsoft Windows Installer and Microsoft .NET Framework 3.5 (or higher). The installer connects to the Internet and downloads Microsoft .NET Framework automatically. Alternatively, before running **ADI_PLL_Frac-N_Setup.msi**, both the installer and .NET Framework can be installed from the CD provided in the evaluation board kit.
2. Connect the SDP board (black) to a PC using the supplied USB cable.
 If you are using Windows XP, follow the steps in the Windows XP SDP-S Board Driver Installation Guide section (see Figure 27 to Figure 30).
 If you are using Windows Vista or Windows 7, the drivers install automatically.

Windows XP Frac-N PLL Software Installation Guide

1. Click Next.

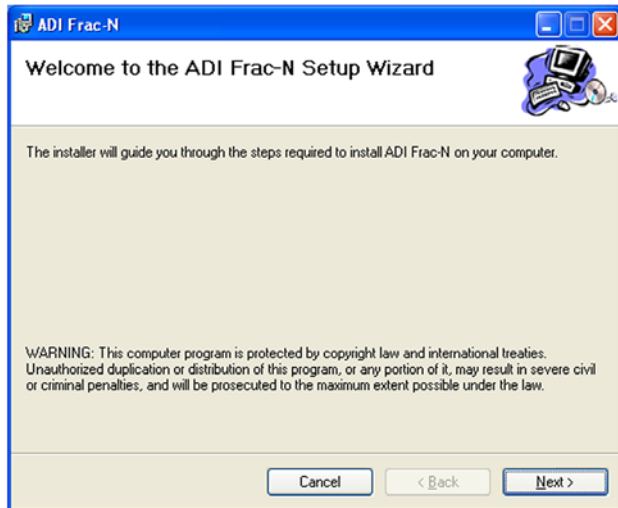

Figure 17. Windows XP Frac-N PLL Software Installation, Setup Wizard

2. Choose an installation directory and click Next.

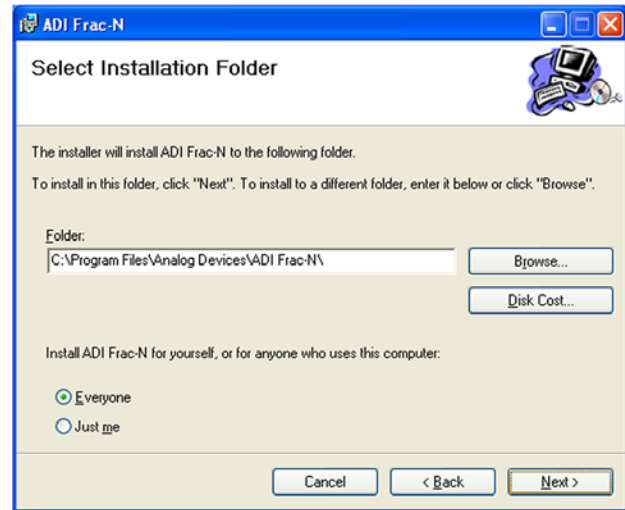

Figure 18. Windows XP Frac-N PLL Software Installation, Select Installation Folder

3. Click Next.

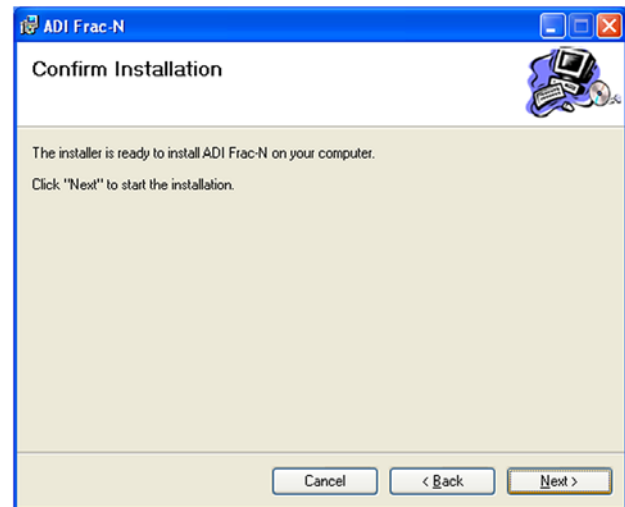

Figure 19. Windows XP Frac-N PLL Software Installation, Confirm Installation

4. Click **Continue Anyway**.

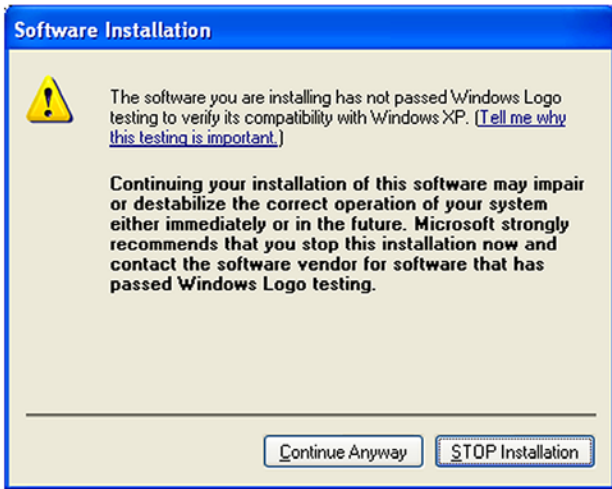

Figure 20. Windows XP Frac-N PLL Software Installation, Logo Testing

5. Click **Close**.

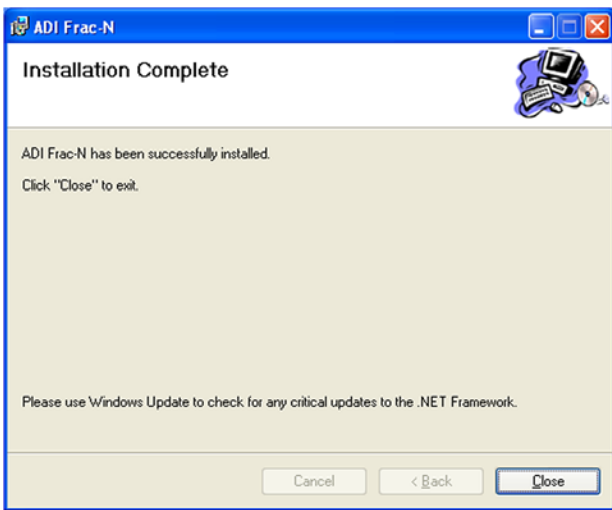

Figure 21. Windows XP Frac-N PLL Software Installation, Installation Complete

Windows Vista and Windows 7 Frac-N PLL Software Installation Guide

1. Click **Next**.

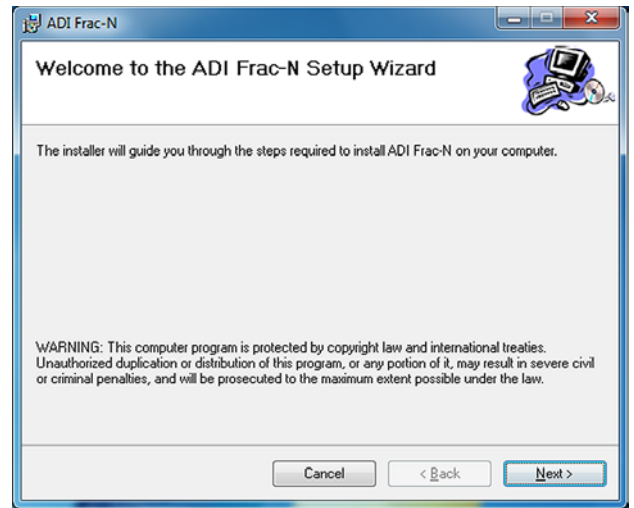

Figure 22. Windows Vista/Windows 7 Frac-N PLL Software Installation, Setup Wizard

2. Choose an installation directory and click **Next**.

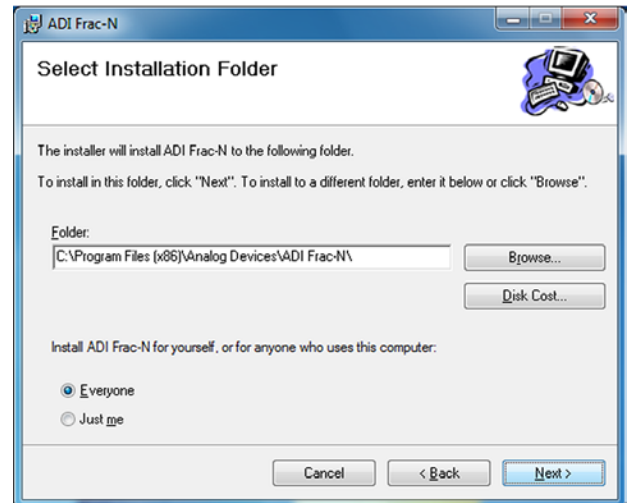

Figure 23. Windows Vista/Windows 7 Frac-N PLL Software Installation, Select Installation Folder

3. Click **Next**.

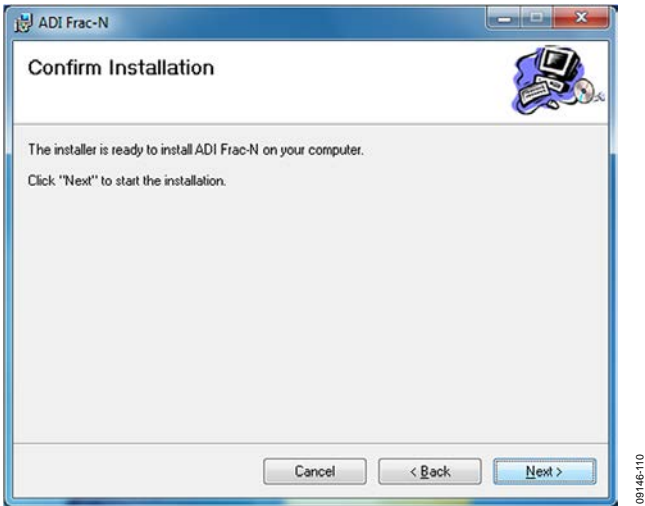

Figure 24. Windows Vista/Windows 7 Frac-N PLL Software Installation, Confirm Installation

5. Click **Close**.

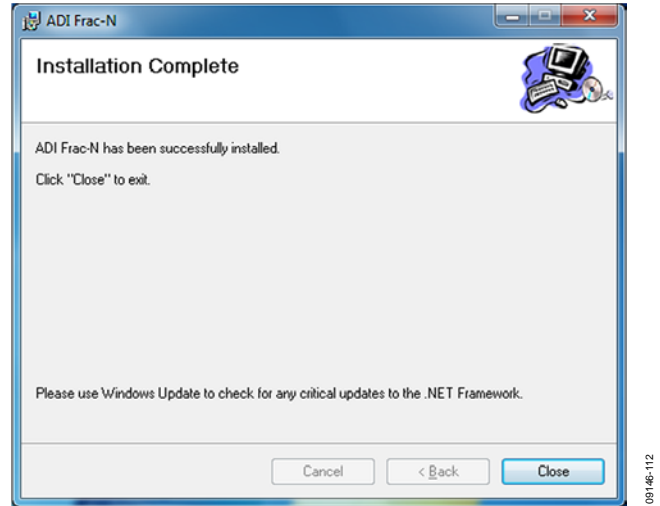

Figure 26. Windows Vista/Windows 7 Frac-N PLL Software Installation, Installation Complete

4. Click **Install**.

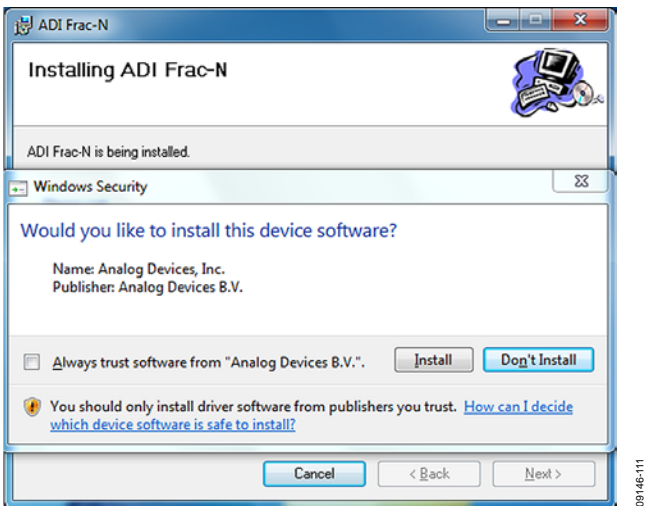

Figure 25. Windows Vista/Windows 7 Frac-N PLL Software Installation, Start Installation

Windows XP SDP-S Board Driver Installation Guide

1. Choose **Yes, this time only**, and then click **Next**.



Figure 27. Windows XP SDP-S Board Driver Installation, Found New Hardware Wizard

2. Click **Next**.

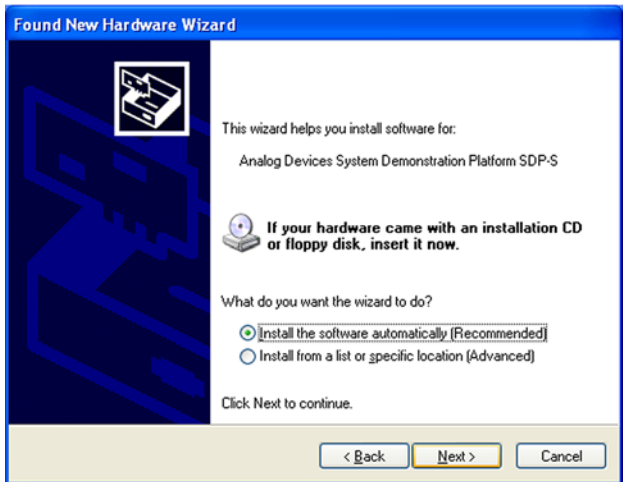

Figure 28. Windows XP SDP-S Board Driver Installation, Installation Options

3. Wait for the installation program to copy all the necessary files.

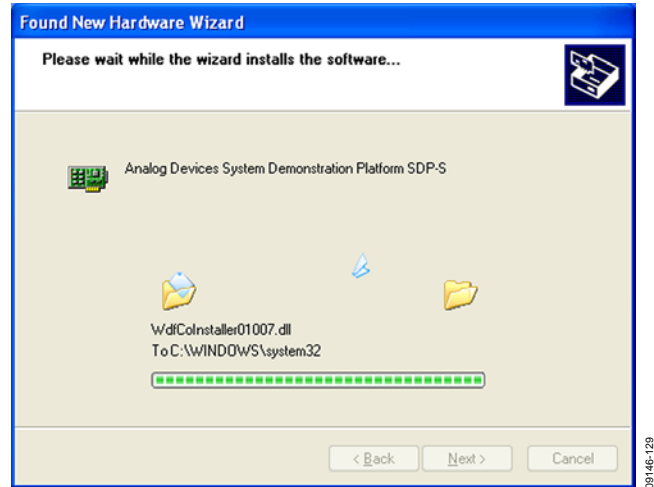

Figure 29. Windows XP SDP-S Board Driver Installation, Progress

4. Click **Finish**.

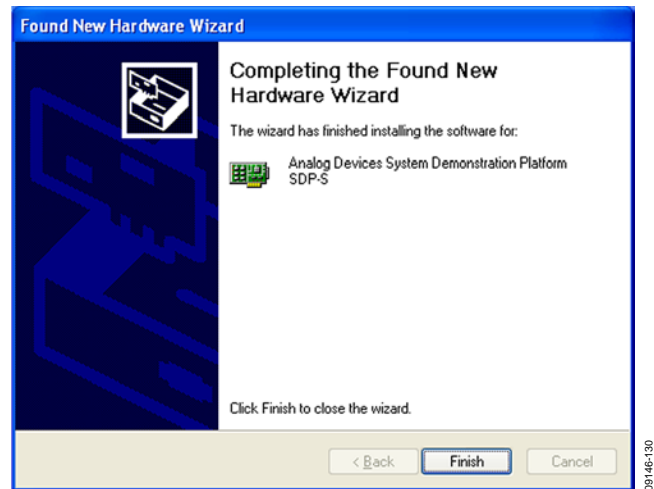

Figure 30. Windows XP SDP-S Board Driver Installation, Complete Installation

EVALUATION BOARD SOFTWARE

INT-N PLL SOFTWARE

The control software for the EV-ADF411XSD1Z is provided on the CD included in the evaluation board kit. To install the software, see the Installing the Int-N PLL Software section.

To run the software, click the **ADI PLL Int-N** file on the desktop or in the **Start** menu.

On the **Select Device and Connection** tab, choose the device and connection method, and then click **Connect**.

Confirm that **SDP board connected** is displayed at the bottom left of the window (see Figure 31). If this message is not displayed, the software cannot connect to the evaluation board.

Note that when the SDP board is connected, there is about a 5 sec to 10 sec delay before the status label changes.

From the **File** menu, the current settings can be saved to and loaded from a text file.

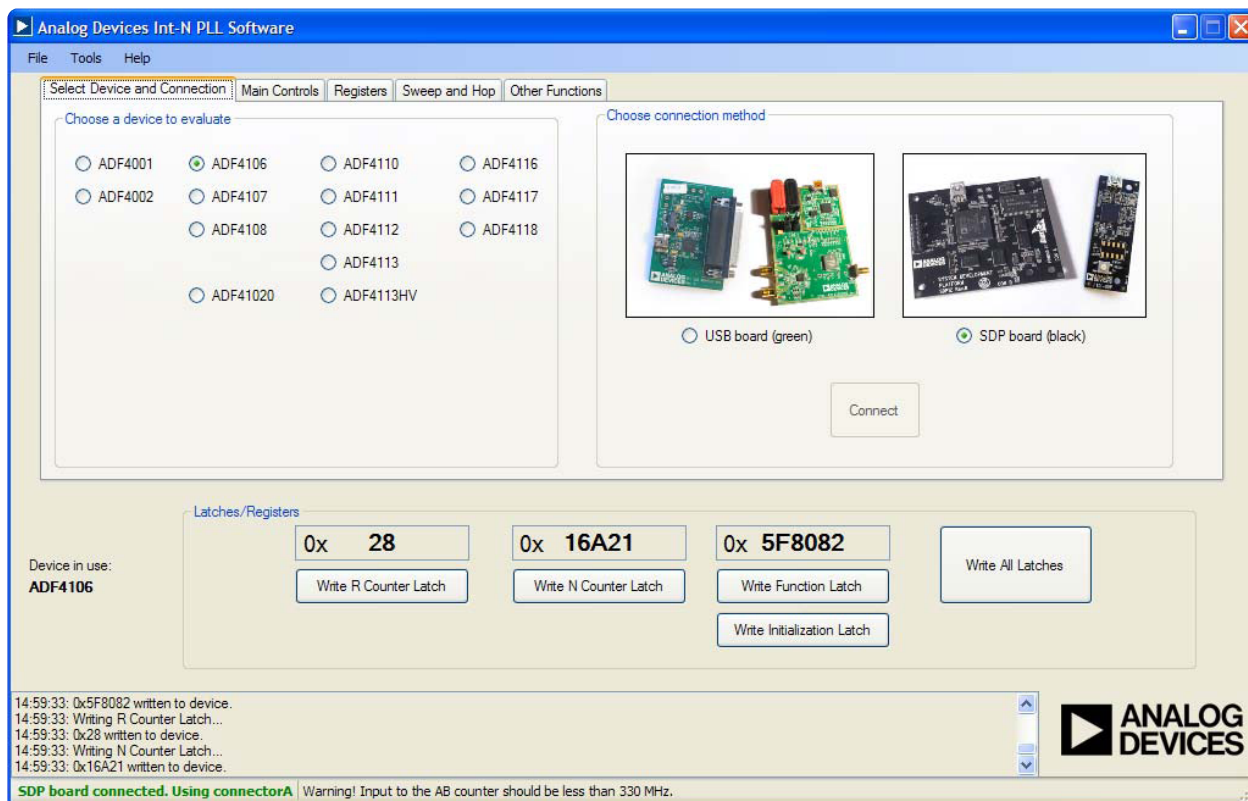

Figure 31. Int-N PLL Software, Main Window—Select Device and Connection

The **Main Controls** tab controls the PLL settings (see Figure 32).

Use the **Reference Frequency** text box to set the correct reference frequency and the reference frequency divider. The default reference frequency in this box is at 10 MHz.

Use the **RF Settings** section to control the output frequency. You can type the desired output frequency in the **RF VCO Output Frequency** text box (in megahertz).

In the **Registers** tab, you can manually input the desired value to be written to the registers.

In the **Sweep and Hop** tab, you can make the device sweep a range of frequencies or hop between two set frequencies.

In the **Latches/Registers** section at the bottom of the **Main Controls** tab of the main window, the values to be written to each register are displayed. If the background on the text box is green, the value displayed is different from the value actually on the device. Click **Write R Counter Latch** or **Write N Counter Latch** to write that value to the device.

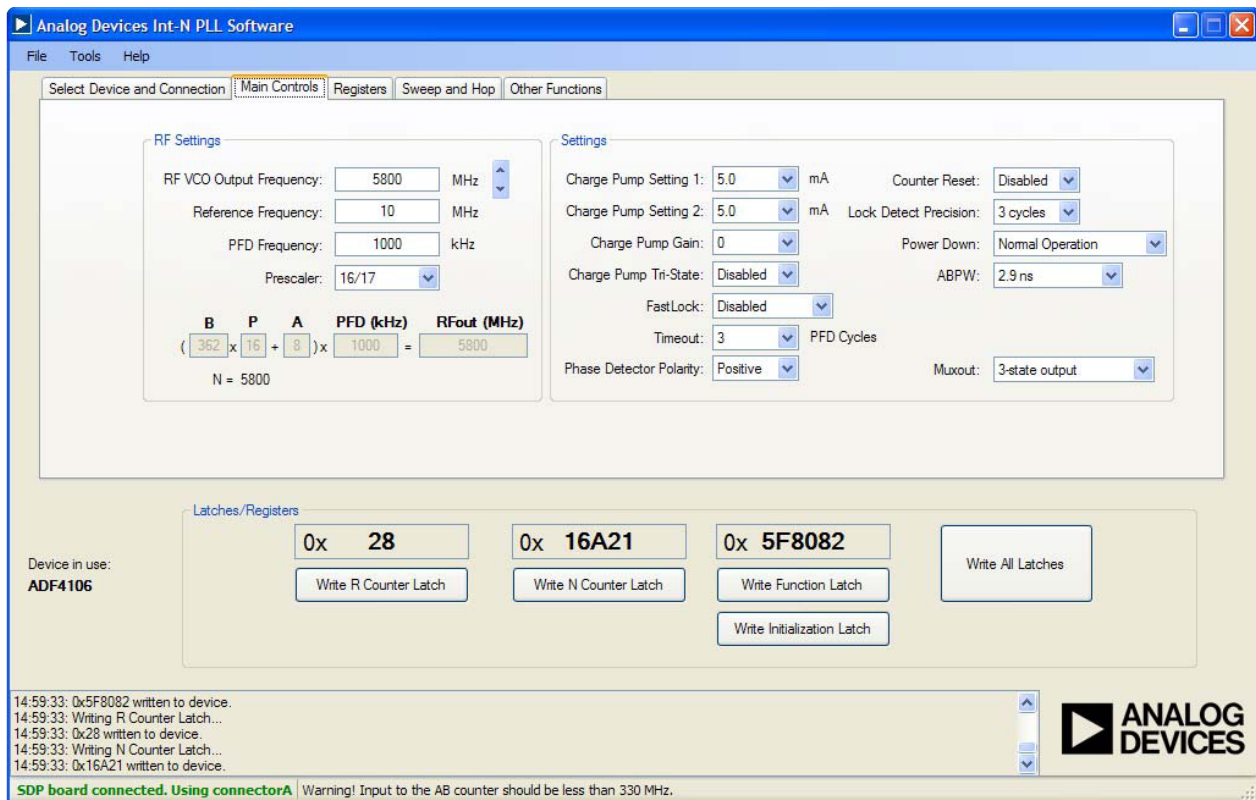

Figure 32. Int-N PLL Software Main Window—Main Controls

FRAC-N PLL SOFTWARE

The control software for the EV-ADF411XSD1Z is provided on the CD included in the evaluation board kit. To install the software, see the Installing the Frac-N PLL Software section.

To run the software, click the **ADI Frac-N** file on the desktop or in the **Start** menu.

On the **Select Device and Connection** tab, choose the device and connection method, and then click **Connect**.

Confirm that **SDP board connected** is displayed at the bottom left of the window (see Figure 33). If this message is not displayed, the software cannot connect to the evaluation board.

Note that when the SDP board is connected, there is about a 5 sec to 10 sec delay before the status label changes.

From the **File** menu, the current settings can be saved to and loaded from a text file.

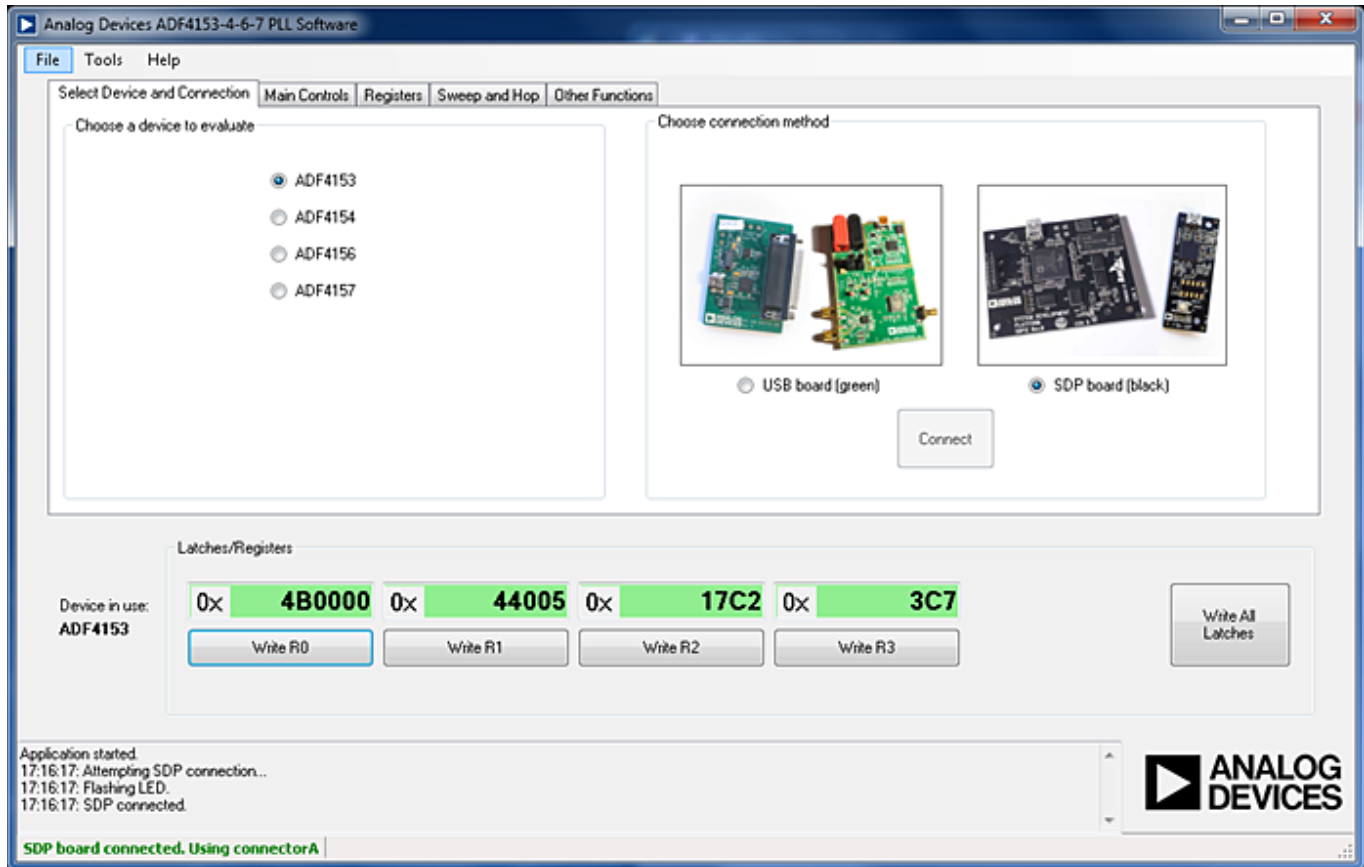

Figure 33. Frac-N PLL Software, Main Window—Select Device and Connection

The **Main Controls** tab controls the PLL settings (see Figure 34). Use the **Reference Frequency** text box to set the correct reference frequency and the reference frequency divider. The default reference frequency in this box is 25 MHz (change this value to 10 MHz if using the supplied on-board TCXO). Use the **RF Settings** section to control the output frequency. You can type the desired output frequency in the **RF VCO Output Frequency** text box (in megahertz). In the **Registers** tab, you can manually input the desired value to be written to the registers.

In the **Sweep and Hop** tab, you can make the device sweep a range of frequencies or hop between two set frequencies. In the **Latches/Registers** section at the bottom of the **Main Controls** tab of the main window, the values to be written to each register are displayed. If the background on the text box is green, the value displayed is different from the value actually on the device. Click **Write Rx** (where x = 0 to 3) to write the value displayed to the device.

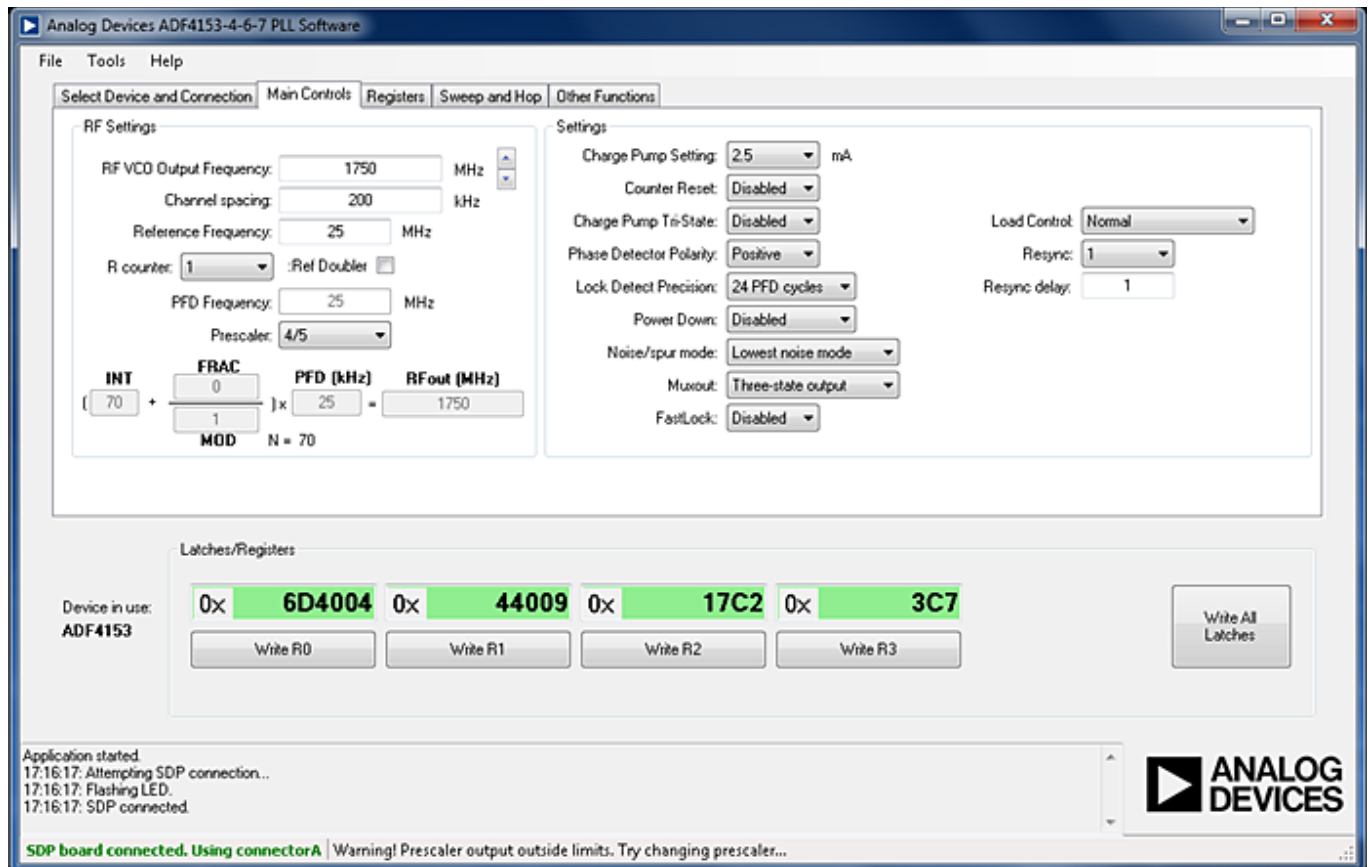

Figure 34. Frac-N PLL Software, Main Window—Main Controls

EVALUATION AND TEST

To evaluate and test the performance of the frequency synthesizer (ADF4110, ADF4111, ADF4112, ADF4113, ADF4116, ADF4117, ADF4118, ADF4106, ADF4107, ADF4153, ADF4154, ADF4156, or ADF4157), use the following procedure:

1. Install the SDP-S software drivers and Int-N or Frac-N PLL software.
2. Connect the SDP board (black) to a PC using the supplied USB cable.
3. Connect the SDP-S connector to the EV-ADF411XSD1Z.
4. Connect the power supplies to banana connectors (6 V to 12 V).
5. Connect a spectrum analyzer to Connector J2.
6. Run the relevant Int-N or Frac-N PLL software.
7. Select the SDP board and the frequency synthesizer in the **Select Device and Connection** tab in the main window of the evaluation board software.
8. In the **Main Controls** tab in the main window of the evaluation board software, set the VCO center frequency in the **RF VCO Output Frequency** text box (Figure 32 uses a 5800 MHz VCO). Set the required value in the **PFD Frequency** text box, and program the **Reference Frequency** value to equal the frequency supplied to Connector J11 (or the TCXO). See Figure 36 for the suggested setup.
9. Measure the output spectrum. Figure 35 shows a 5800 MHz output.

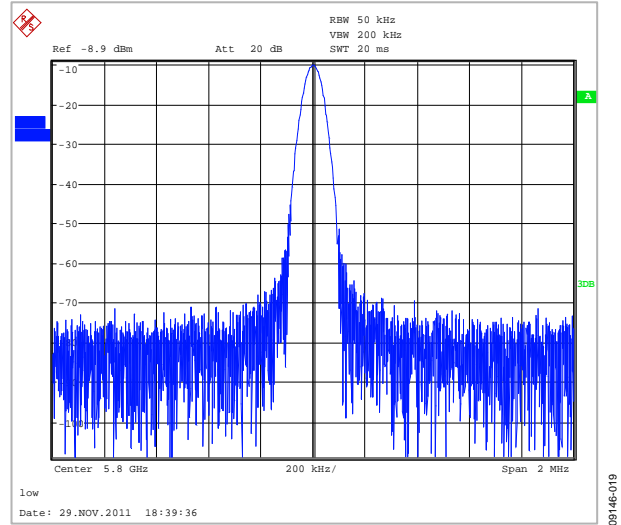

Figure 35. Spectrum Analyzer Display

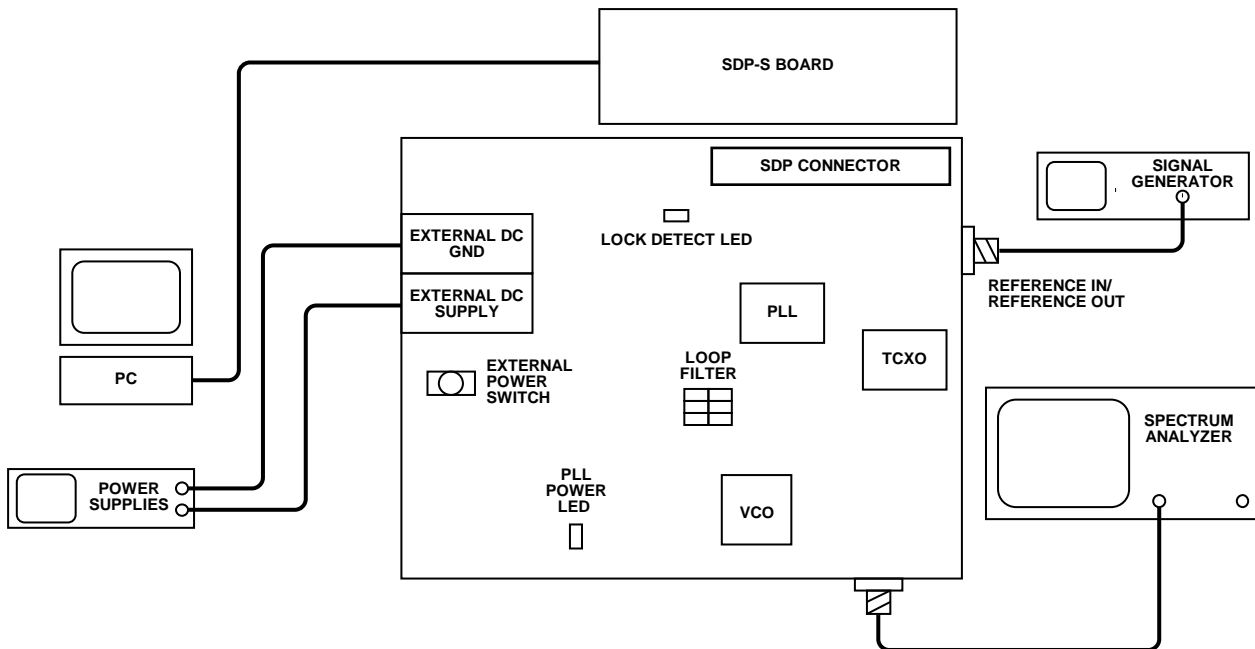
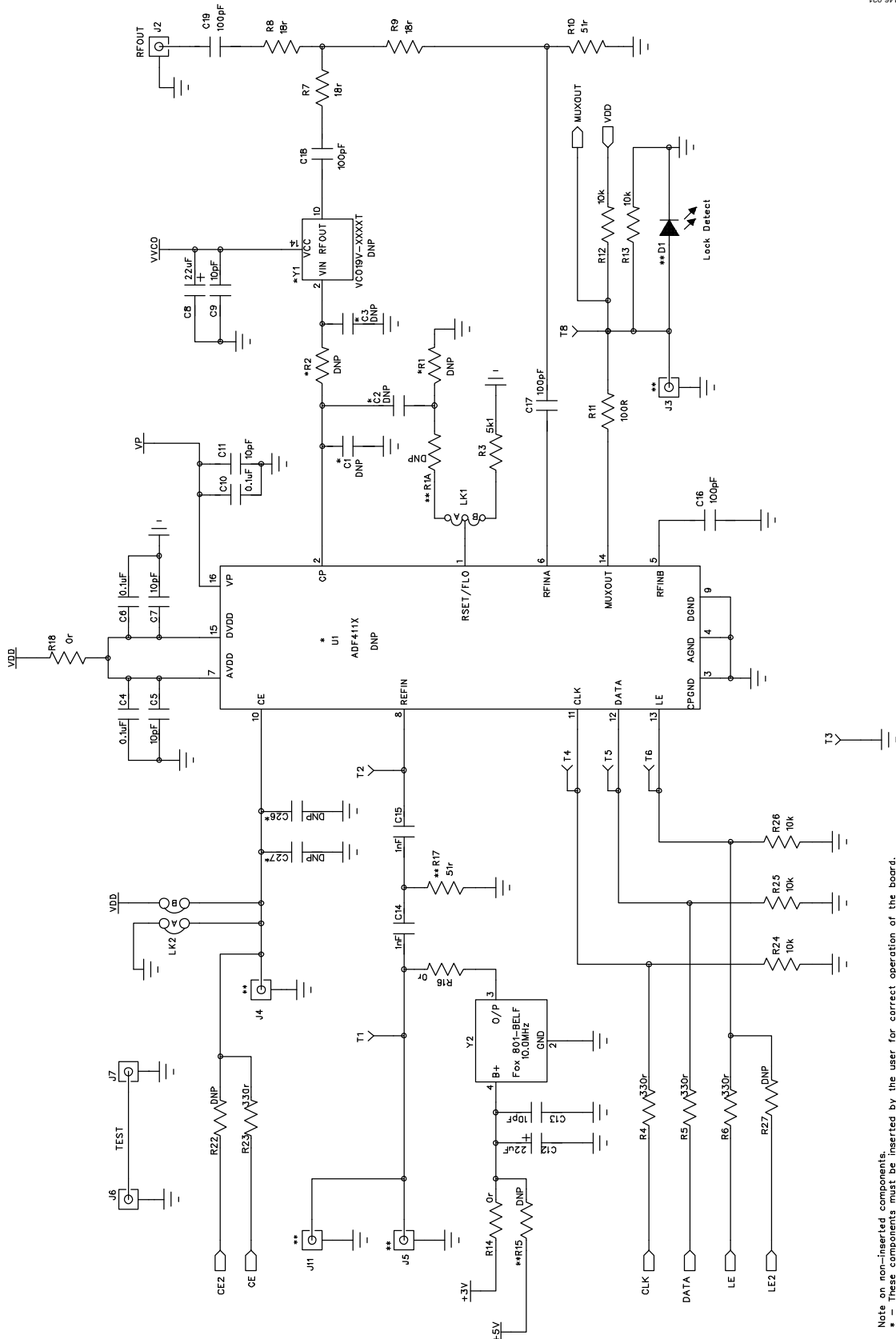

Figure 36. Typical Evaluation Setup

EVALUATION BOARD SCHEMATICS AND ARTWORK

120-99160



Note on non-inserted components.
 * - These components must be inserted by the user for correct operation of the board.
 ** - These components can be inserted by the user for expansion purposes.

Figure 37. Evaluation Board Schematic (Page 1)
 Rev. A | Page 19 of 28

09146-022

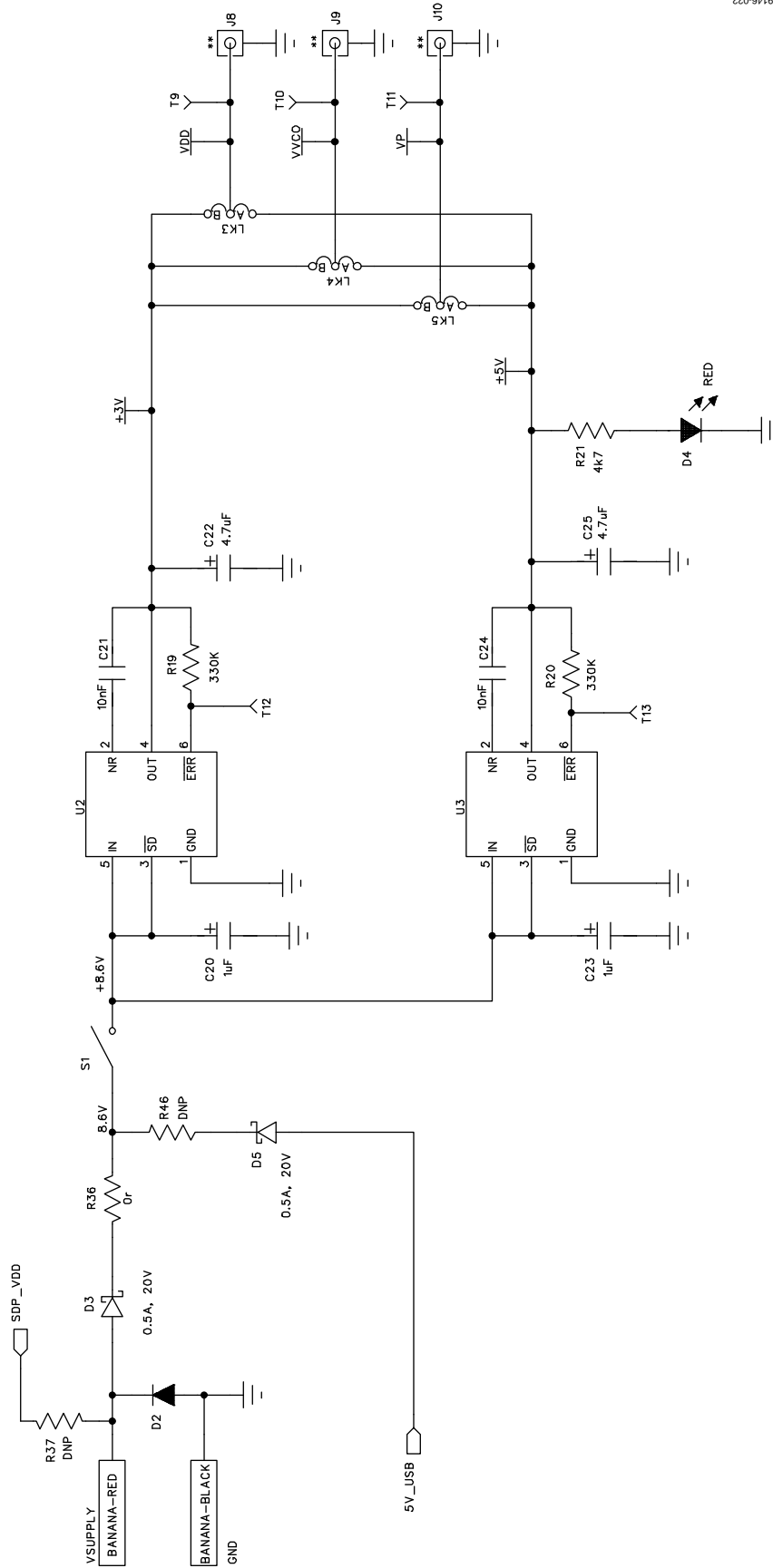
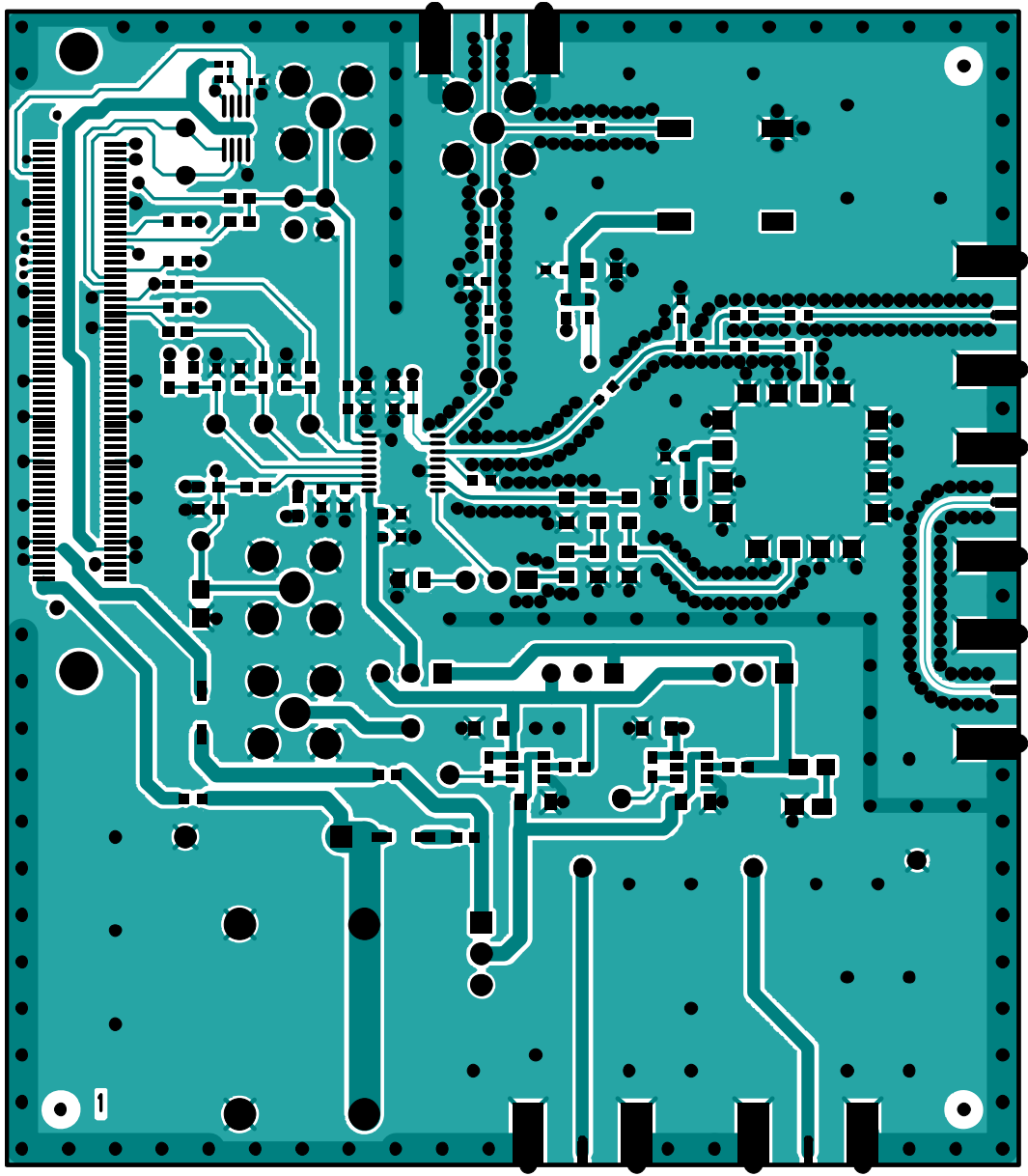

Figure 38. Evaluation Board Schematic (Page 2)



00146-024

Figure 40. Layer 1 (Component Side)

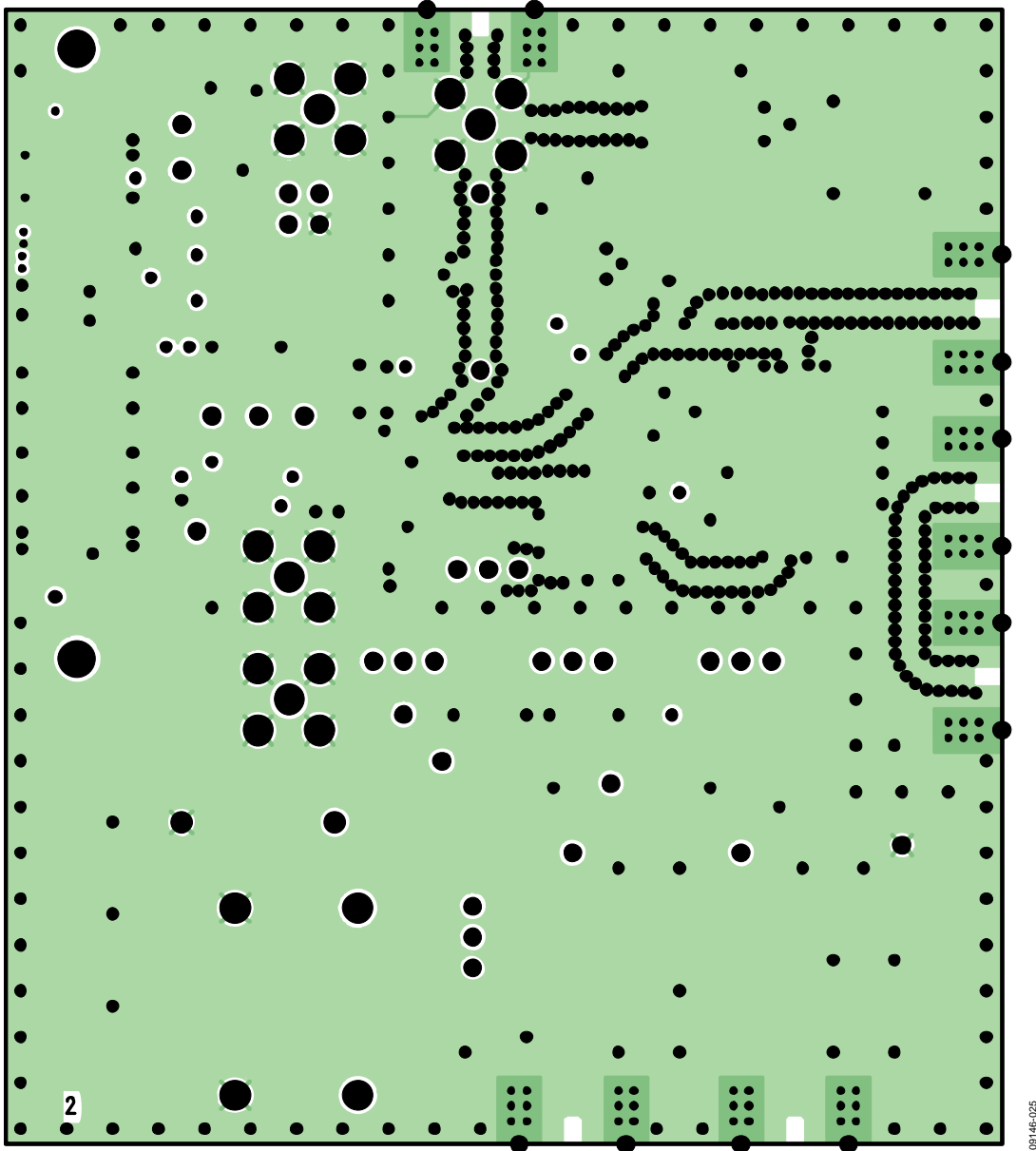
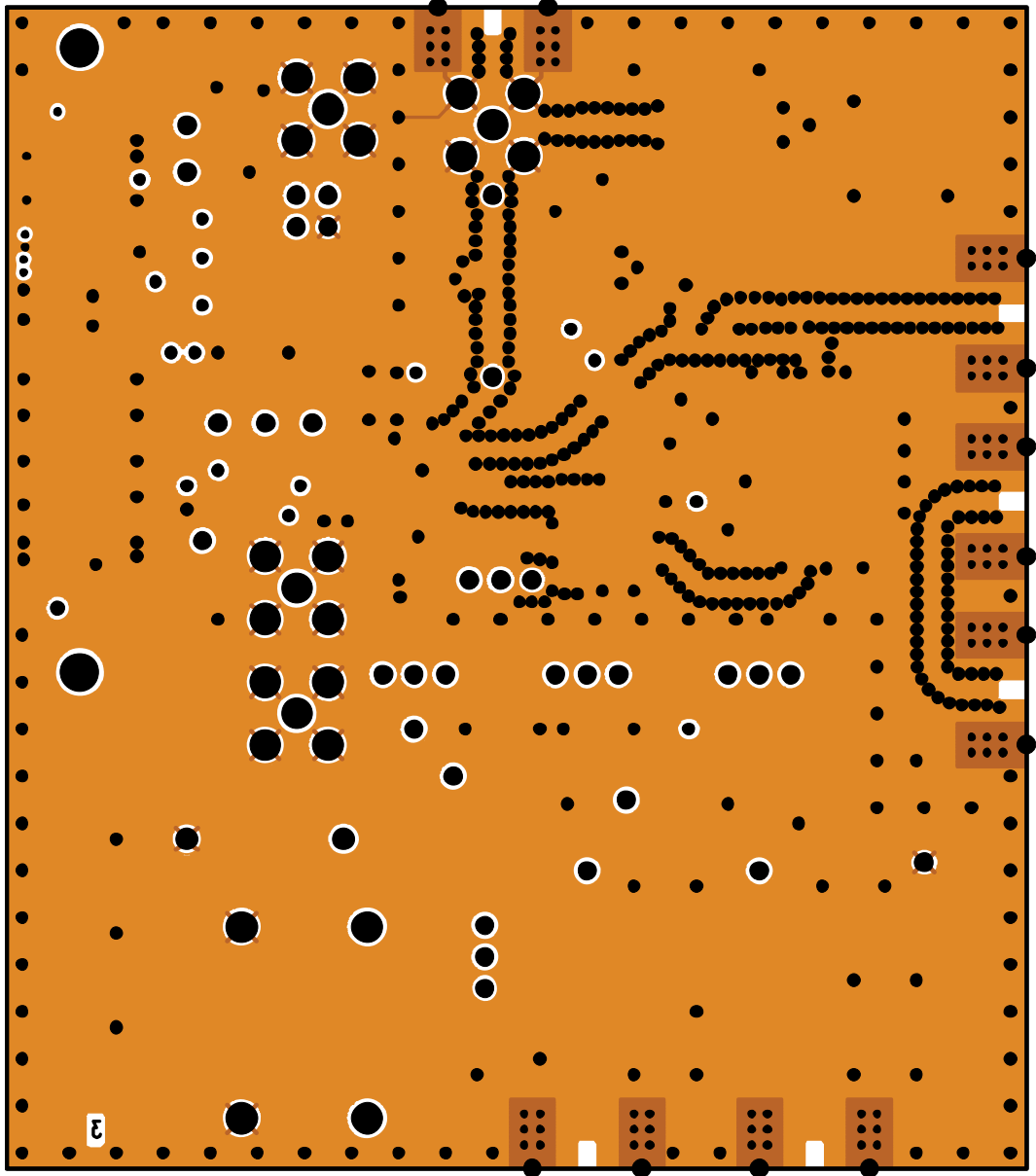

Figure 41. Layer 2 (Ground Plane)

09146-025



00146-026

Figure 42. Layer 3 (Power Plane)

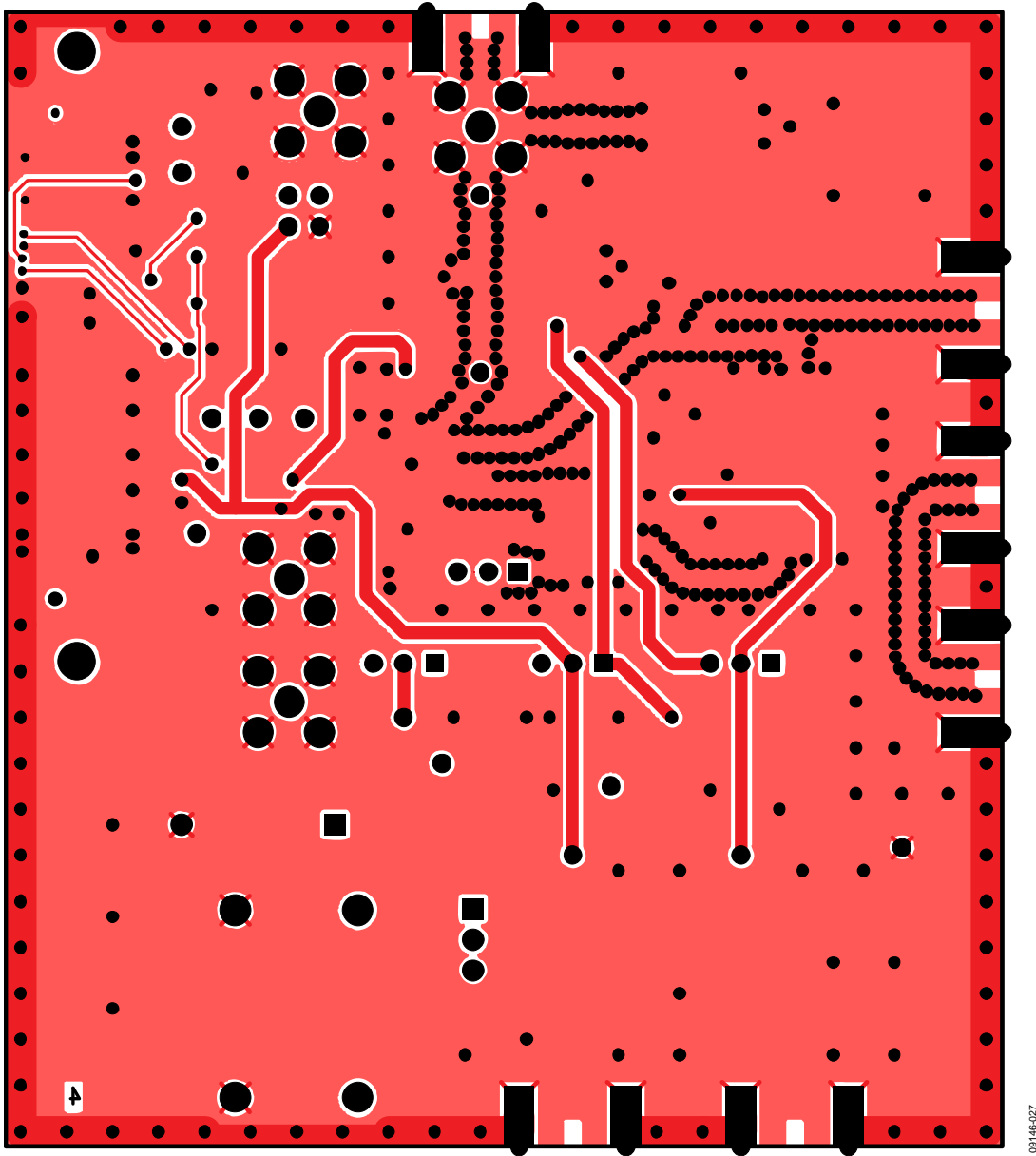

Figure 43. Layer 4 (Solder Side)

09146-027

BILL OF MATERIALS

Table 2.

Reference Designator	Part Description	Manufacturer/Part No.
C1	Capacitor, 0805, 100 pF, 50 V	User supplied
C2	Capacitor, 0805, 1.5 nF, 50 V	User supplied
C3	Capacitor, 0805, 22 pF, 50 V	User supplied
C4, C6, C10	Capacitor, 0402, 0.1 μ F, 16 V	AVX CM105X7R104K16AT
C5, C7, C9, C11, C13	Capacitor, 0603, 10 pF, 50 V, SMD	AVX 06035A100JAT2A
C8, C12	Capacitor, Case A, 22 μ F, 6.3 V	AVX TAJA226K006R
C14, C15	Capacitor, 0603, 1 nF, 50 V	AVX 06035A102JAT2A
C16, C17, C18, C19	Capacitor, 0603, 100 pF, 50 V	AVX 06035A101JAT2A
C20, C23	Capacitor, Case A, 1 μ F, 16 V	AVX TAJA105K016R
C21, C24	Capacitor, 0603, 10 nF, 50 V	AVX 06035C103JAT2A
C22, C25	Capacitor, Case A, 4.7 μ F, 10 V	AVX TAJA475K010R
C26, C27	Capacitor, 0603, 10 nF, 50 V	Not inserted
D1	LED, green	OSRAM LGR971-Z
D2	Diode, DO41, 1 A, 50 V	Multicomp 1N4001
D3, D5	SD103C, 6.2 V	ON Semiconductor MBR0520LT1G
D4	LED, red	Avago HSMS-C170
J1	120-way connector, 0.6 mm pitch	Hirose FX8-120S-SV(21)
J2	Jack, SMA, SMA_EDGE	Johnson Components 142-0701-851
J3, J4, J10, J11	Jack, SMA, receptacle straight PCB	Not inserted
J5, J6, J7, J8, J9	Jack, SMA, SMA_EDGE	Not inserted
LK1, LK3, LK4, LK5	Jumper-2\SIP3, 3-pin link	Harwin M20-9990345 and M7566-05
LK2	Jumper-2	Harwin M20-9990245 and M7566-05
GND	Black 4 mm banana socket	Deltron 571-0100-01
VSUPPLY	Red 4 mm banana socket	Deltron 571-0500-01
R1A	Resistor, 0805	User supplied
R1	Resistor, 0805	User supplied
R2	Resistor, 0805	User supplied
R3	Resistor, 0805, 5.1 k Ω , \pm 1%, 0.1 W	Multicomp MC 0.1 0805 1% 5K1
R4, R5, R6, R23, R29, R42	Resistor, 0603, 330 Ω	Multicomp MC 0.063W 0603 1% 330R
R7, R8, R9	Resistor, 0603, 18 Ω	Multicomp MC 0.063W 0603 1% 18R
R10, R17	Resistor, 0603, 51 Ω	Multicomp MC 0.063W 0603 1% 51R
R11	Resistor, 0603 100 Ω	Multicomp MC 0.0625W 0402 1% 100R
R12, R13, R24, R25, R26	Resistor, 0603, 10 k Ω	Multicomp MC 0.063W 0603 1% 10K
R14, R16, R18, R28, R36	Resistor, 0603, 0 Ω	Multicomp MC 0.063W 0603 1% 0R
R15, R22, R27, R32, R33, R37, R46	Resistor, 0603, 0 Ω	Not inserted
R19, R20	Resistor, 0603, 330 k Ω , \pm 1%, 0.063 W	Multicomp MC 0.063W 0603 1% 330K
R21	Resistor, 0603, 4.7 k Ω , \pm 1%, 0.063 W	Multicomp MC 0.063W 0603 1% 4K7
R30	Resistor, 0402	Not inserted
R31, R34	Resistor, RC31, 0402, 100 k Ω	YAGEO (Phycomp) RC0402JR-07100KL
S1	Switch, PCB, SPDT, 20 V	APEM TL36P0050
T1 to T14	Test point, PCB, red PK_100	Vero 20-313137
U1	ADF41XX, ¹ 16-lead TSSOP	User supplied
U3	ADP3300, 6-lead SOT-23	ADP3300ART-5
U2	ADP3300, 6-lead SOT-23	ADP3300ART-3
U4	32k I ² C serial EEPROM, MSOP8	Microchip 24LC32A-I/MS
Y1	VCO19V-XXXXT	User supplied
Y2	Low profile/temperature compensated crystal oscillator, OSC_TCXO, 10 W	Fox Electronics 801-BELF

¹ ADF41XX = ADF4110, ADF4111, ADF4112, ADF4113, ADF4116, ADF4117, ADF4118, ADF4106, ADF4107, ADF4153, ADF4154, ADF4156, or ADF4157.

RELATED LINKS

Resource	Description
ADF4110	Product Page: Single, Integer-N, 550 MHz PLL with Programmable Prescaler and Charge Pump
ADF4111	Product Page: Single, Integer-N, 1.2 GHz PLL with Programmable Prescaler and Charge Pump
ADF4112	Product Page: Single, Integer-N 3.0 GHz PPL with Programmable Prescaler and Charge Pump
ADF4113	Product Page: Single, Integer-N 4.0 GHz PLL with Programmable Prescaler and Charge Pump
ADF4116	Product Page: Single, Integer-N 550 MHz PLL
ADF4117	Product Page: Single, Integer-N 1.2 GHz PLL
ADF4118	Product Page: Single, Integer-N, 3.0 GHz PLL
ADF4106	Product Page: PLL Frequency Synthesizer
ADF4107	Product Page: PLL Frequency Synthesizer
ADF4153	Product Page: Fractional-N Frequency Synthesizer
ADF4154	Product Page: Fractional-N Frequency Synthesizer
ADF4156	Product Page: 6.2 GHz Fractional-N Frequency Synthesizer
ADF4157	Product Page: High Resolution 6 GHz Fractional-N Frequency Synthesizer
ADP3300	Product Page: High Accuracy anyCAP® 50 mA Low Dropout Linear Regulator
ADSP-BF527	Product Page: Low Power Blackfin Processor with Advanced Peripherals
SDP-S	Product Page: System Demonstration Platform-Serial (SDP-S)
SDP-B	Product Page: System Demonstration Platform-Blackfin (SDP-B)
UG-161	User Guide: Evaluation Board for the Integer-N and Fractional-N PLL Frequency Synthesizer
UG-291	User Guide: SDP-S Controller Board
UG-277	User Guide: SDP-B Controller Board

NOTES

I²C refers to a communications protocol originally developed by Philips Semiconductors (now NXP Semiconductors).

**ESD Caution**

ESD (electrostatic discharge) sensitive device. Charged devices and circuit boards can discharge without detection. Although this product features patented or proprietary protection circuitry, damage may occur on devices subjected to high energy ESD. Therefore, proper ESD precautions should be taken to avoid performance degradation or loss of functionality.

Legal Terms and Conditions

By using the evaluation board discussed herein (together with any tools, components documentation or support materials, the "Evaluation Board"), you are agreeing to be bound by the terms and conditions set forth below ("Agreement") unless you have purchased the Evaluation Board, in which case the Analog Devices Standard Terms and Conditions of Sale shall govern. Do not use the Evaluation Board until you have read and agreed to the Agreement. Your use of the Evaluation Board shall signify your acceptance of the Agreement. This Agreement is made by and between you ("Customer") and Analog Devices, Inc. ("ADI"), with its principal place of business at One Technology Way, Norwood, MA 02062, USA. Subject to the terms and conditions of the Agreement, ADI hereby grants to Customer a free, limited, personal, temporary, non-exclusive, non-sublicensable, non-transferable license to use the Evaluation Board FOR EVALUATION PURPOSES ONLY. Customer understands and agrees that the Evaluation Board is provided for the sole and exclusive purpose referenced above, and agrees not to use the Evaluation Board for any other purpose. Furthermore, the license granted is expressly made subject to the following additional limitations: Customer shall not (i) rent, lease, display, sell, transfer, assign, sublicense, or distribute the Evaluation Board; and (ii) permit any Third Party to access the Evaluation Board. As used herein, the term "Third Party" includes any entity other than ADI, Customer, their employees, affiliates and in-house consultants. The Evaluation Board is NOT sold to Customer; all rights not expressly granted herein, including ownership of the Evaluation Board, are reserved by ADI. CONFIDENTIALITY. This Agreement and the Evaluation Board shall all be considered the confidential and proprietary information of ADI. Customer may not disclose or transfer any portion of the Evaluation Board to any other party for any reason. Upon discontinuation of use of the Evaluation Board or termination of this Agreement, Customer agrees to promptly return the Evaluation Board to ADI. ADDITIONAL RESTRICTIONS. Customer may not disassemble, decompile or reverse engineer chips on the Evaluation Board. Customer shall inform ADI of any occurred damages or any modifications or alterations it makes to the Evaluation Board, including but not limited to soldering or any other activity that affects the material content of the Evaluation Board. Modifications to the Evaluation Board must comply with applicable law, including but not limited to the RoHS Directive. TERMINATION. ADI may terminate this Agreement at any time upon giving written notice to Customer. Customer agrees to return to ADI the Evaluation Board at that time. LIMITATION OF LIABILITY. THE EVALUATION BOARD PROVIDED HEREUNDER IS PROVIDED "AS IS" AND ADI MAKES NO WARRANTIES OR REPRESENTATIONS OF ANY KIND WITH RESPECT TO IT. ADI SPECIFICALLY DISCLAIMS ANY REPRESENTATIONS, ENDORSEMENTS, GUARANTEES, OR WARRANTIES, EXPRESS OR IMPLIED, RELATED TO THE EVALUATION BOARD INCLUDING, BUT NOT LIMITED TO, THE IMPLIED WARRANTY OF MERCHANTABILITY, TITLE, FITNESS FOR A PARTICULAR PURPOSE OR NON-INFRINGEMENT OF INTELLECTUAL PROPERTY RIGHTS. IN NO EVENT WILL ADI AND ITS LICENSORS BE LIABLE FOR ANY INCIDENTAL, SPECIAL, INDIRECT, OR CONSEQUENTIAL DAMAGES RESULTING FROM CUSTOMER'S POSSESSION OR USE OF THE EVALUATION BOARD, INCLUDING BUT NOT LIMITED TO LOST PROFITS, DELAY COSTS, LABOR COSTS OR LOSS OF GOODWILL. ADI'S TOTAL LIABILITY FROM ANY AND ALL CAUSES SHALL BE LIMITED TO THE AMOUNT OF ONE HUNDRED US DOLLARS (\$100.00). EXPORT. Customer agrees that it will not directly or indirectly export the Evaluation Board to another country, and that it will comply with all applicable United States federal laws and regulations relating to exports. GOVERNING LAW. This Agreement shall be governed by and construed in accordance with the substantive laws of the Commonwealth of Massachusetts (excluding conflict of law rules). Any legal action regarding this Agreement will be heard in the state or federal courts having jurisdiction in Suffolk County, Massachusetts, and Customer hereby submits to the personal jurisdiction and venue of such courts. The United Nations Convention on Contracts for the International Sale of Goods shall not apply to this Agreement and is expressly disclaimed.