

DATA SHEET



SCA820-D04 1-AXIS HIGH PERFORMANCE ACCELEROMETER WITH DIGITAL SPI INTERFACE

Features

- 3.3V supply voltage
- ± 2 g measurement range
- Single axis measurement in Z direction
- ± 30 mg offset accuracy over temp range
- SPI digital interface
- Enhanced self diagnostics features
- Size 7.6 x 3.3 x 8.6 mm (w x h x l)
- Qualified according to AEC-Q100 standard
- Package, pin-out and SPI protocol compatible with VTI digital accelerometer product family
- RoHS compliant Dual Flat Lead (DFL) plastic package suitable for lead free soldering process and SMD mounting
- Proven capacitive 3D-MEMS technology

Applications

SCA820-D04 is targeted to automotive applications with high stability requirements. Typical applications

- Hill Start Aid (HSA)
- Electronic Parking Brake (EPB)
- Roll Over detection
- Suspension control
- Motion and position measurements

General Description

SCA820-D04 is a single axis inclinometer component based on VTI's capacitive 3D-MEMS technology. The component integrates high accuracy micromechanical acceleration sensing together with a flexible SPI digital interface. Dual Flat Lead (DFL) housing guarantees reliable operation over product lifetime.

SCA820-D04 is designed, manufactured and tested for high stability, reliability and quality requirements of automotive applications. The inclinometer has an extremely stable output over wide ranges of temperature, humidity and mechanical noise. The component is qualified to the AEC-Q100 standard and has several advanced self diagnostics features. The DFL housing is suitable for SMD mounting and the component is compatible with the RoHS and ELV directives.

SCA820-D04 is a part of VTI digital accelerometer family and fully compatible with multi axis accelerometers (SCA2100 series and SCA3100 series) and other single axis accelerometers (SCA800 series).

Performance Characteristics

Vdd=3.3 V and ambient temperature unless otherwise specified.

Parameter	Condition				
		Min	Typ ^{A)}	Max	Units
Analog and digital Vdd		3.0		3.6	V
Current consumption	Active mode		5	6.3	mA
	Power down mode			0.1	mA
Measurement range	Measurement axes (Z)	-2		2	g
Operating temperature		-40		125	°C
Offset total error ^{B)}	Temperature range -40 ... +125 °C	-70		70	mg
Offset calibration error ^{C)}	@25 °C ±5°C	-40	±18	40	mg
Offset temperature drift	Temperature range -40 ... +125 °C	-30 ^{D)}	±25 ^{E)}	30 ^{D)}	mg
	Temperature range -20 ... +85 °C		±15		mg
Sensitivity	12 bit output		900		Count/g
	Between ±3°		0.0637		°/Count
Total sensitivity error	Temperature range -40 ... +125 °C	-4		4	% FS
Sensitivity calibration error	@25 °C ±5°C		±1.1		% FS
Sensitivity temperature drift	Temperature range -40 ... +125 °C		±1.3		% FS
Linearity error	+1g ... -1g range, end point fit	-20		20	mg
	+2g ... -2g range, end point fit	-40		40	mg
Cross-Axis sensitivity				±3.5	%
Zero acceleration output	2-complement		0		Counts
Amplitude response	-3dB frequency	30		80	Hz
Noise			2	5	mg RMS
Power on setup time				0.1	s
Output data rate			2000		Hz
Output load				50	pF
SPI clock rate				8	MHz
ESD	Human Body Model			2	kV
	Charge Device Model			1	kV
Solderability	IPC/JEDEC J-STD-020C, +245 °C, 40 s				
Moisture level	IPC/JEDEC J-STD-020C, Level 3				
Mechanical shock				20 000	g
ID register value	Customer readable ID register (27hex)		04		

- A) Typical ± values are ±3 sigma variation limits from validation test population.
 B) Includes offset deviation from 0g value including calibration error and drift over lifetime, temperature and supply voltage.
 C) Includes offset deviation from 0g value including calibration error and drift over lifetime.
 D) Offset drift due to temperature. Value is a relative value and has been centered to zero. Error defined as maximum change of offset in temperature range. Offset (max)-Offset Min). 100% tested in production.
 E) Biggest change of output from RT value due temperature.

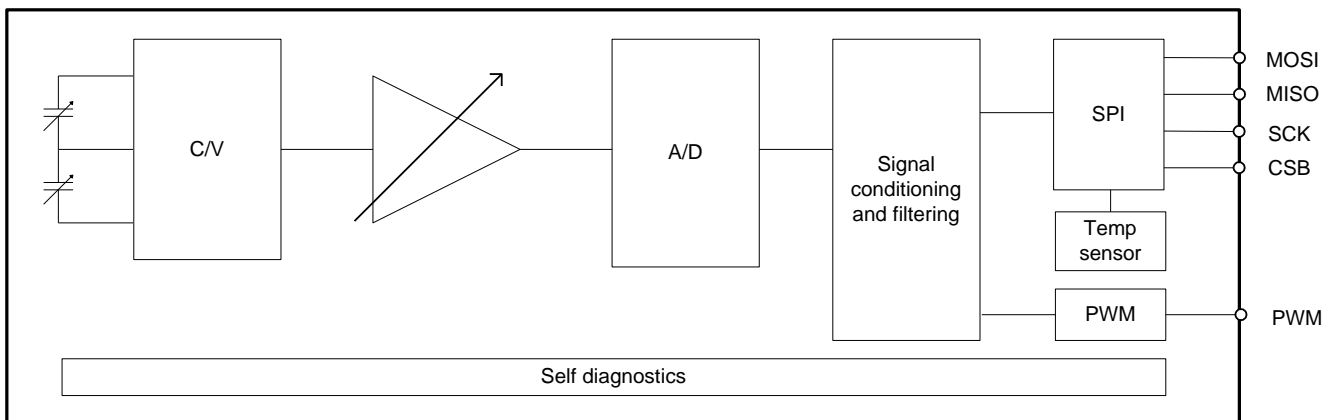
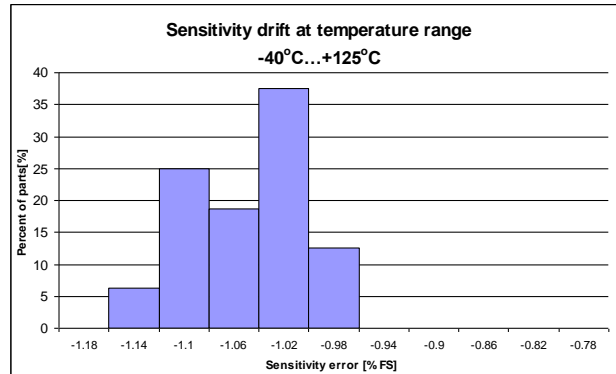
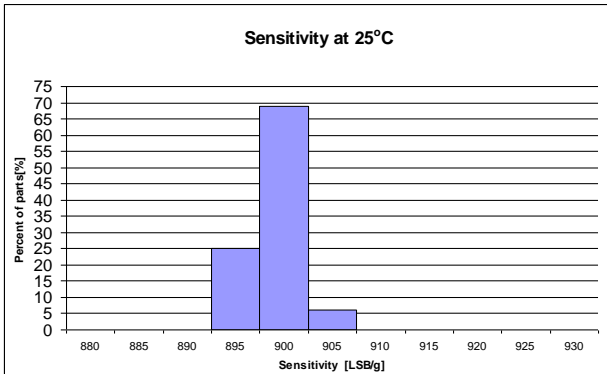
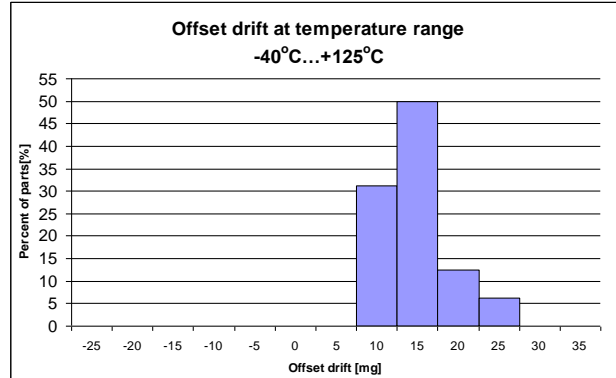
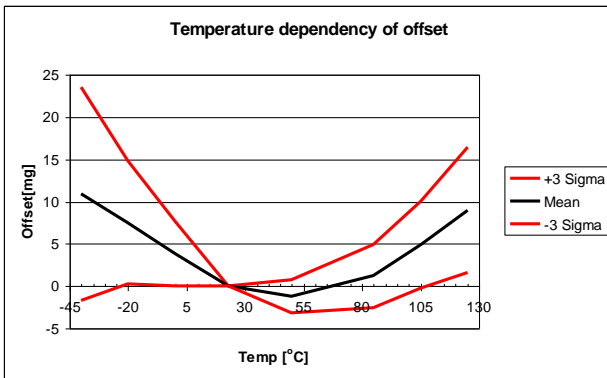
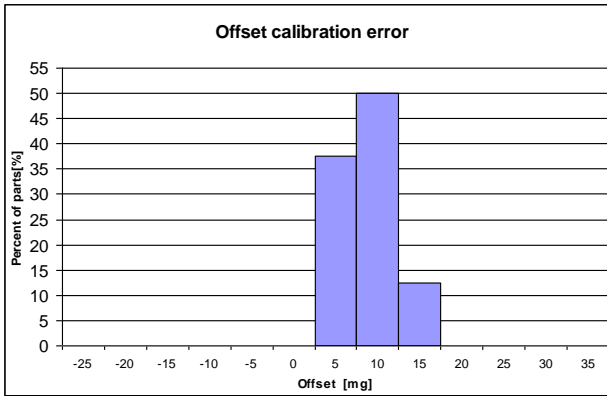

Figure 1. SCA820-D04 Block Diagram

Typical Performance characteristics



Measurement directions

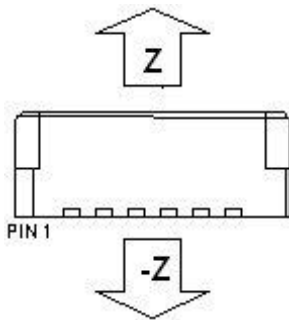

Figure 2. Accelerometer measuring directions.

Housing dimensions

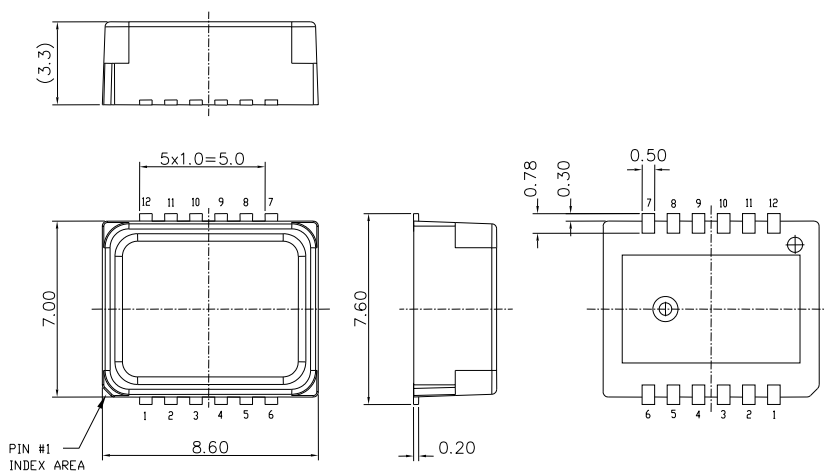

Figure 3. Housing dimensions