

High Voltage BIMOSFET™ Monolithic Bipolar MOS Transistor

N-Channel, Enhancement Mode

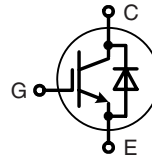

$I_{C25} = 33 \text{ A}$
 $V_{CES} = 1600 \text{ V}$
 $V_{CE(sat)} = 6.2 \text{ V typ.}$
 $t_{fi} = 40 \text{ ns}$

TO-247 AD

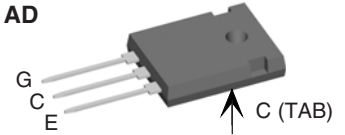

G = Gate,
E = Emitter, C = Collector,
TAB = Collector

Symbol	Conditions	Maximum Ratings	
V_{CES}	$T_J = 25^\circ\text{C to } 150^\circ\text{C}$	1600	V
V_{CGR}	$T_J = 25^\circ\text{C to } 150^\circ\text{C}; R_{GE} = 1 \text{ M}\Omega$	1600	V
V_{GES}	Continuous	± 20	V
V_{GEM}	Transient	± 30	V
I_{C25}	$T_C = 25^\circ\text{C}$	33	A
I_{C90}	$T_C = 90^\circ\text{C}$	20	A
I_{CM}	$T_C = 25^\circ\text{C}, 1 \text{ ms}$	40	A
SSOA (RBSOA)	$V_{GE} = 15 \text{ V}, T_{VJ} = 125^\circ\text{C}, R_G = 22 \Omega, V_{CE} = 0.8 \cdot V_{CES}$ Clamped inductive load, $L = 100 \mu\text{H}$	$I_{CM} = 40$	A
P_C	$T_C = 25^\circ\text{C}$	350	W
T_J		-55 ... +150	$^\circ\text{C}$
T_{JM}		150	$^\circ\text{C}$
T_{stg}		-55 ... +150	$^\circ\text{C}$
T_L	1.6 mm (0.063 in) from case for 10 s	300	$^\circ\text{C}$
M_d	Mounting torque	1.15/10Nm/lb.in.	
Weight		6	g

Features

- International standard package JEDEC TO-247 AD
- High Voltage BIMOSFET™
 - replaces high voltage Darlington's and series connected MOSFET's
 - lower effective $R_{DS(on)}$
- Monolithic construction
 - high blocking voltage capability
 - very fast turn-off characteristics
- MOS Gate turn-on
 - drive simplicity
- Intrinsic diode

Applications

- AC motor speed control
- DC servo and robot drives
- DC choppers
- Uninterruptible power supplies (UPS)
- Switched-mode and resonant-mode power supplies
- CRT deflection
- Lamp ballasts

Advantages

- Easy to mount with 1 screw (isolated mounting screw hole)
- Space savings
- High power density

Symbol	Conditions	Characteristic Values ($T_J = 25^\circ\text{C}$, unless otherwise specified)		
		min.	typ.	max.
BV_{CES}	$I_C = 1 \text{ mA}, V_{GE} = 0 \text{ V}$	1600		V
$V_{GE(th)}$	$I_C = 2 \text{ mA}, V_{CE} = V_{GE}$	4		8 V
I_{CES}	$V_{CE} = 0.8 \cdot V_{CES}$ $V_{GE} = 0 \text{ V}$			$T_J = 25^\circ\text{C}$ 400 μA $T_J = 125^\circ\text{C}$ 3 mA
I_{GES}	$V_{CE} = 0 \text{ V}, V_{GE} = \pm 20 \text{ V}$			$\pm 500 \text{ nA}$
$V_{CE(sat)}$	$I_C = I_{C90}, V_{GE} = 15 \text{ V}$		6.2	$T_J = 125^\circ\text{C}$ 7.1 V 7.8 V

Symbol	Conditions	Characteristic Values		
		(T _J = 25°C, unless otherwise specified)		
		min.	typ.	max.
C _{ies} C _{oes} C _{res}	V _{CE} = 25 V, V _{GE} = 0 V, f = 1 MHz		3300	pF
			220	pF
			30	pF
Q _g	I _C = 20 A, V _{CE} = 600 V, V _{GE} = 15 V		130	nC
t _{d(on)} t _{ri} t _{d(off)} t _{fi}	Inductive load, T _J = 125°C I _C = I _{C90} , V _{GE} = 15 V, L = 100 μH, V _{CE} = 960 V, R _G = 22 Ω		200	ns
			60	ns
			270	ns
			40	ns
R _{thJC} R _{thCK}			0.35	K/W K/W
		0.25		

Symbol	Conditions	Characteristic Values		
		(T _J = 25°C, unless otherwise specified)		
		min.	typ.	max.
V _F	I _F = I _{C90} , V _{GE} = 0 V, Pulse test t ≤ 300 μs, duty cycle d ≤ 2%		2.5	5 V

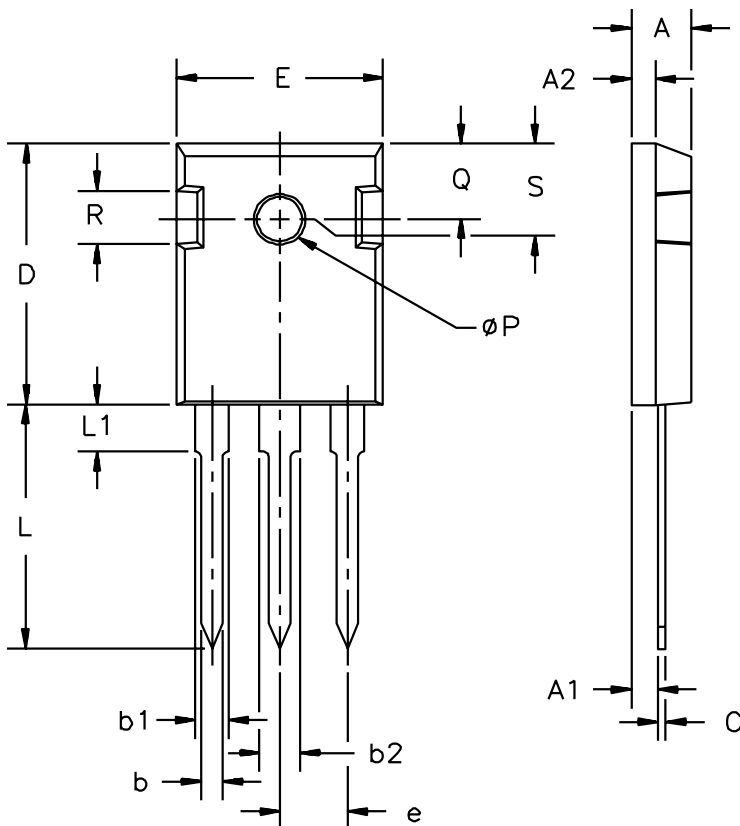
TO-247 AD Outline

Dim.	Millimeter		Inches	
	Min.	Max.	Min.	Max.
A	19.81	20.32	0.780	0.800
B	20.80	21.46	0.819	0.845
C	15.75	16.26	0.610	0.640
D	3.55	3.65	0.140	0.144
E	4.32	5.49	0.170	0.216
F	5.4	6.2	0.212	0.244
G	1.65	2.13	0.065	0.084
H	-	4.5	-	0.177
J	1.0	1.4	0.040	0.055
K	10.8	11.0	0.426	0.433
L	4.7	5.3	0.185	0.209
M	0.4	0.8	0.016	0.031
N	1.5	2.49	0.087	0.102

IXYS reserves the right to change limits, test conditions and dimensions.

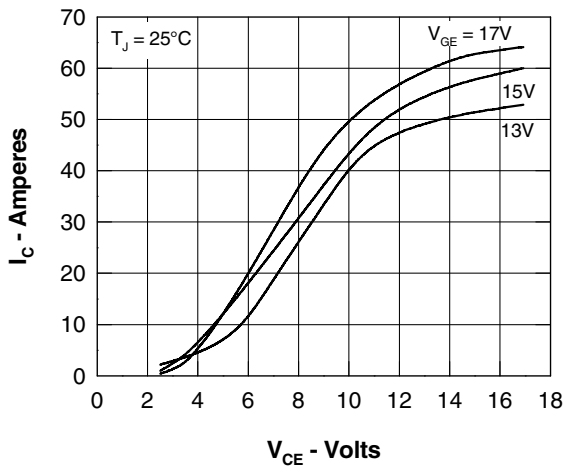

Fig. 1 Typ. Output Characteristics

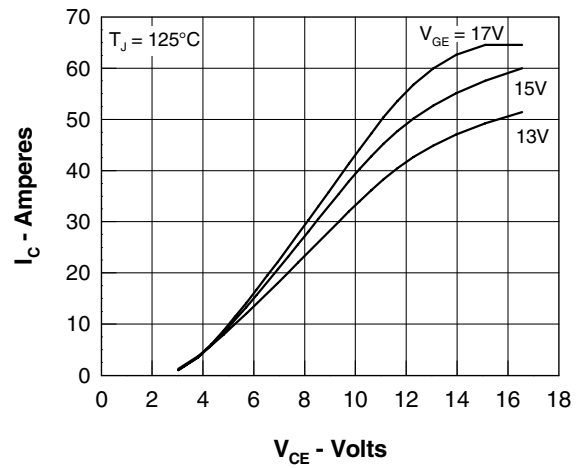

Fig. 2 Typ. Output Characteristics

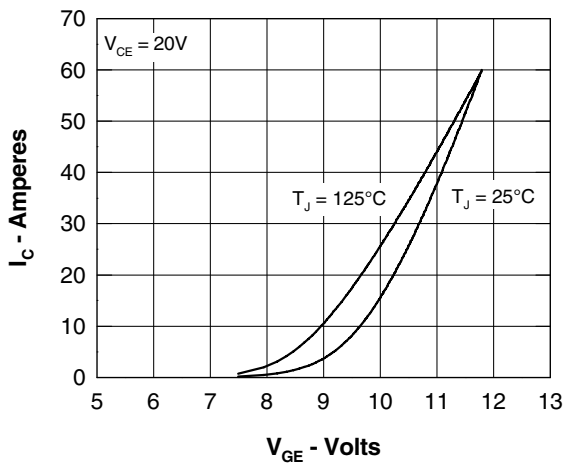

Fig. 3 Typ. Transfer Characteristics

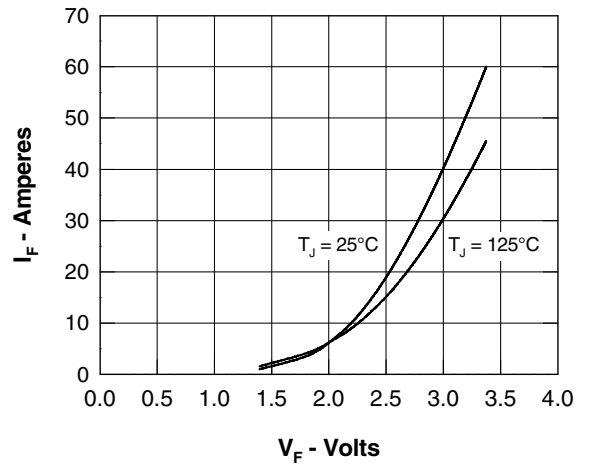

Fig. 4 Typ. Characteristics of Reverse Conduction

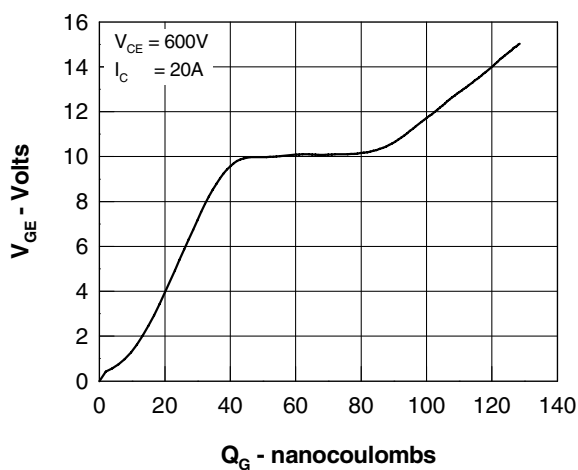

Fig. 5 Typ. Gate Charge characteristics

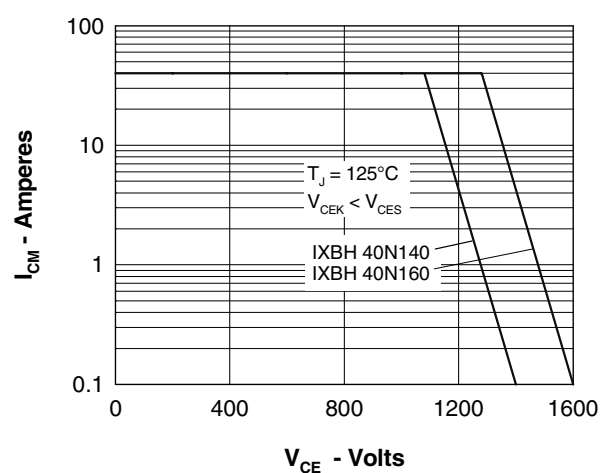

Fig. 6 Reverse Based Safe Operating Area RBSOA

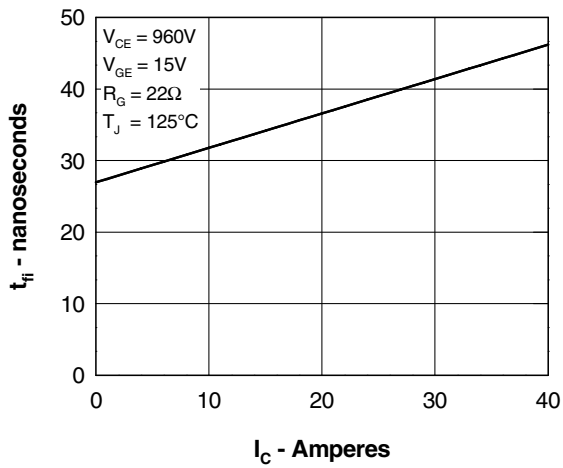

Fig. 7 Typ. Fall Time

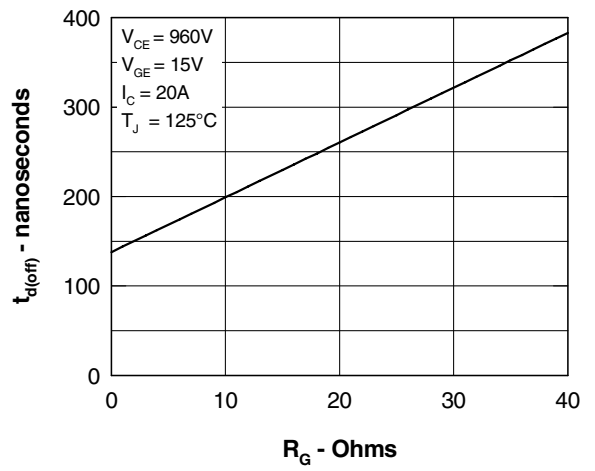

Fig. 8 Typ. Turn Off Delay Time

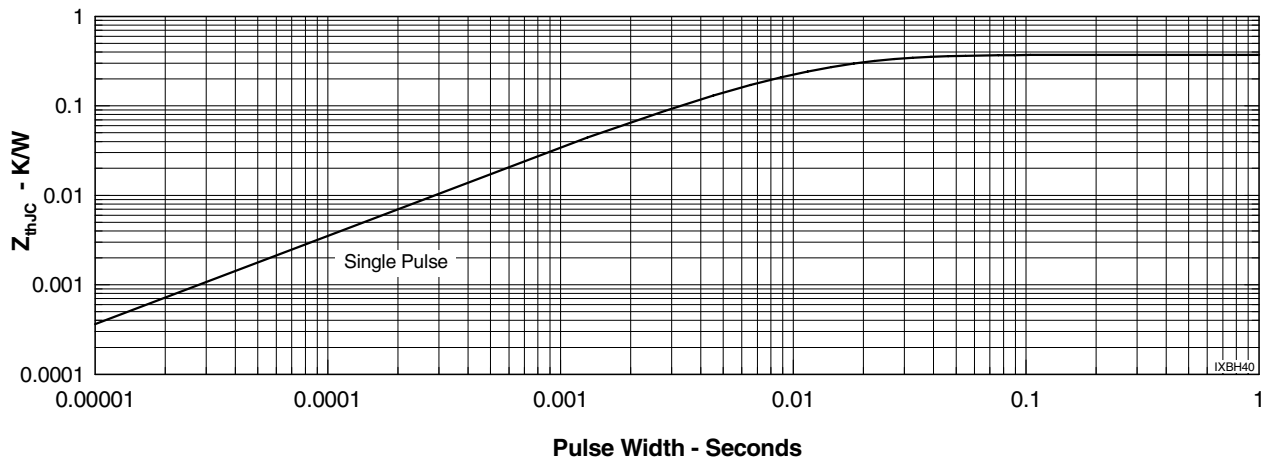

Fig. 9 Typ. Transient Thermal Impedance