

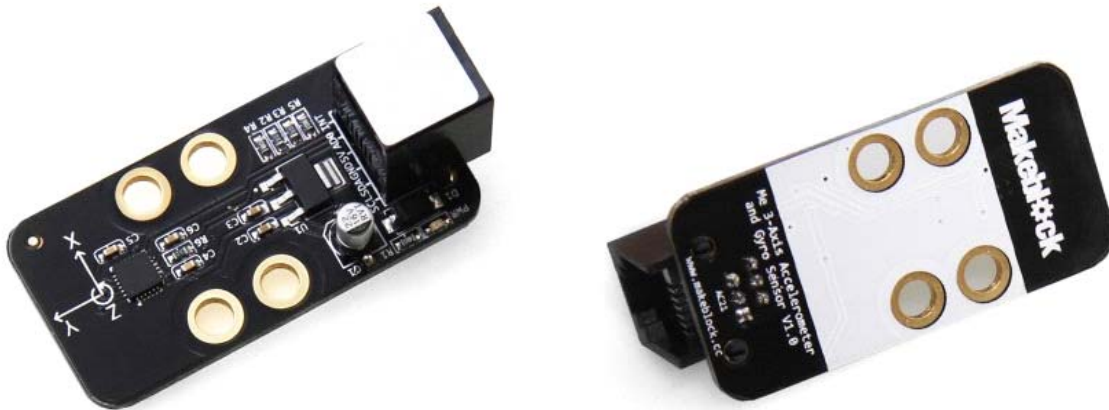

Me 3-Axis Accelerometer and Gyro Sensor

SKU: 11012 Weight: 20.00 Gram



Description:

Me 3-Axis Accelerometer and Gyro Sensor is a motion processing module. It can use to measure the angular rate and the acceleration information of your robot or other devices.

Me 3-Axis Accelerometer and Gyro Sensor is based on MPU-6050, it combines a 3-axis gyroscope, 3-axis accelerometer, and a Digital Motion Processor™ (DMP) capable of processing complex 9-axis Motion Fusion algorithms.

Features:

- Tri-Axis angular rate sensor (gyro) with a sensitivity up to 131 LSBs/dps and a full-scale range of ± 250 , ± 500 , ± 1000 , and ± 2000 dps
- Tri-Axis accelerometer with a programmable full scale range of $\pm 2g$, $\pm 4g$, $\pm 8g$ and $\pm 16g$
- Digital Motion Processing™ (DMP™) engine offloads complex MotionFusion, sensor timing synchronization and gesture detection
- Embedded algorithms for run-time bias and compass calibration. No user intervention required
- I2C Digital-output of 6 or 9-axis MotionFusion data in rotation matrix, quaternion, Euler Angle, or raw data format
- 16mm interval M4 mounting holes, compatible with Makeblock beams
- Easy wiring with 6 Pin RJ25 interface

Specification

- RatedVoltage: 5V
- Size:24x48x 32mm(Length x Width x Height)

Overview

The Me 3-Axis Accelerometer and Gyro Sensor is an ideal module for motion and posture detection of robot. It includes a 3-axis accelerometer, a 3-axis angular velocity sensor, and a motion processor, and provides I2C port for communication. It can be applied on the self-balancing cart, 4-axis aircraft, robot, and mobile devices. It has the advantage of high-dynamic measurement range and low current consumption. Its white ID means that it's in I2C communication mode and should be connected to the port with white ID on Makeblock Orion.

Technical specifications

- Input voltage: 5V DC
- Signal mode: I²C communication
- Module size: 51 x 24 x 18 mm (L x W x H)

Functional characteristics

- White area of module is the reference area to contact metal beams
- Digital output of 6-axis or 9-axis synthetical operation data of such formats as rotation matrix, quaternion, and Euler angle
- 3-axis angular velocity sensor controlled measurement range: ± 250 , ± 500 , ± 1000 , $\pm 2000^\circ/\text{s}$ (dps)
- 3-axis accelerometer controlled measurement range: $\pm 2\text{g}$, $\pm 4\text{g}$, $\pm 8\text{g}$, and $\pm 16\text{g}$
- Digital Motion Processing (DMP) engine is provided to reduce the load of complex motion integration, sensor synchronization, and posture detection
- Eliminate the axial sensitivity between accelerometer and gyro; reduce the influence of settings and drifting of sensor
- Embedded calibration algorithm of operation time deviation and magnetic force sensor
- Anti-reverse protection – connecting the power supply inversely will not damage IC
- Support mBlock GUI programming, and applicable to users of all ages
- Adopt RJ25 port for easy connection
- Provide pin-type of port to support most development boards including Arduino series

Pin definition

The port of Me 3-Axis Accelerometer and Gyro Sensor has 4 pins, and their functions are as follows:

No.	Pin	Function
1	SCL	I ² C data port
2	SDA	I ² C clock port
3	GND	Grounding
4	VCC	Power supply

Wiring mode

- Connecting with Rj25

Since the port of Me 3-Axis Accelerometer and Gyro Sensor has white ID, you need to connect the port with white ID on Makeblock Orion when using RJ25 port. Taking Makeblock Orion as example, you can connect it to ports No. 3, 4, 6, 7, and 8 as follows:

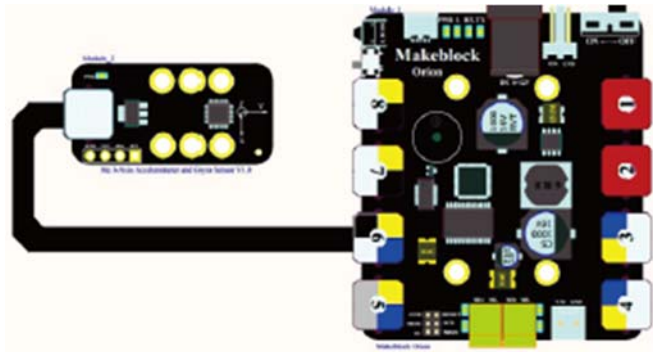

Figure 1 Connecting Me 3-Axis Accelerometer and Gyro Sensor to Makeblock Orion

- Connecting with Dupont wire

When the Dupont wire is used to connect the module to the Arduino UNO Baseboard, its SCL and SDA pins should be connected to I2C port, that is, the port A5 and A4 respectively as follows:

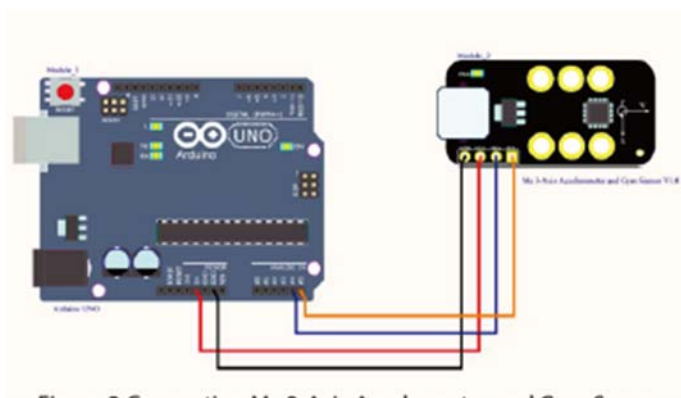

Figure 2 Connecting Me 3-Axis Accelerometer and Gyro Sensor
Note: When Dupont wire is used, pin header should be welded on the module.

Guide to programming

- Arduino programming

If you use Arduino to write a program, the library Makeblock-Library-master should be invoked to control the Me 3-Axis Accelerometer and Gyro Sensor. This is a routine wrote in Arduino. When any value is input through the serial monitor, the module receives it and returns the current value of X, Y, and Z, so that we can identify the posture of current module. We can see the value of X, Y, and Z on the serial monitor.

```
01 #include "MeOrion.h"
02 #include <Wire.h>
03 MeGyro gyro;
04 void setup()
05 {
06     Serial.begin(9600);
07     gyro.begin();
08 }
09 void loop()
10 {
11     gyro.update();
12     Serial.read();
13     Serial.print("X:");
14     Serial.print(gyro.getAngleX());
15     Serial.print(" Y:");
16     Serial.print(gyro.getAngleY());
17     Serial.print(" Z:");
18     Serial.println(gyro.getAngleZ());
19     delay(10);
20 }
```

Function List of Me 3-Axis Accelerometer and Gyro Sensor

Function name	Function
angleX()	Read the angle value of X-axis
angleY()	Read the angle value of Y-axis
angleZ()	Read the angle value of Z-axis
update()	Update the output of module
begin()	Initialize the module

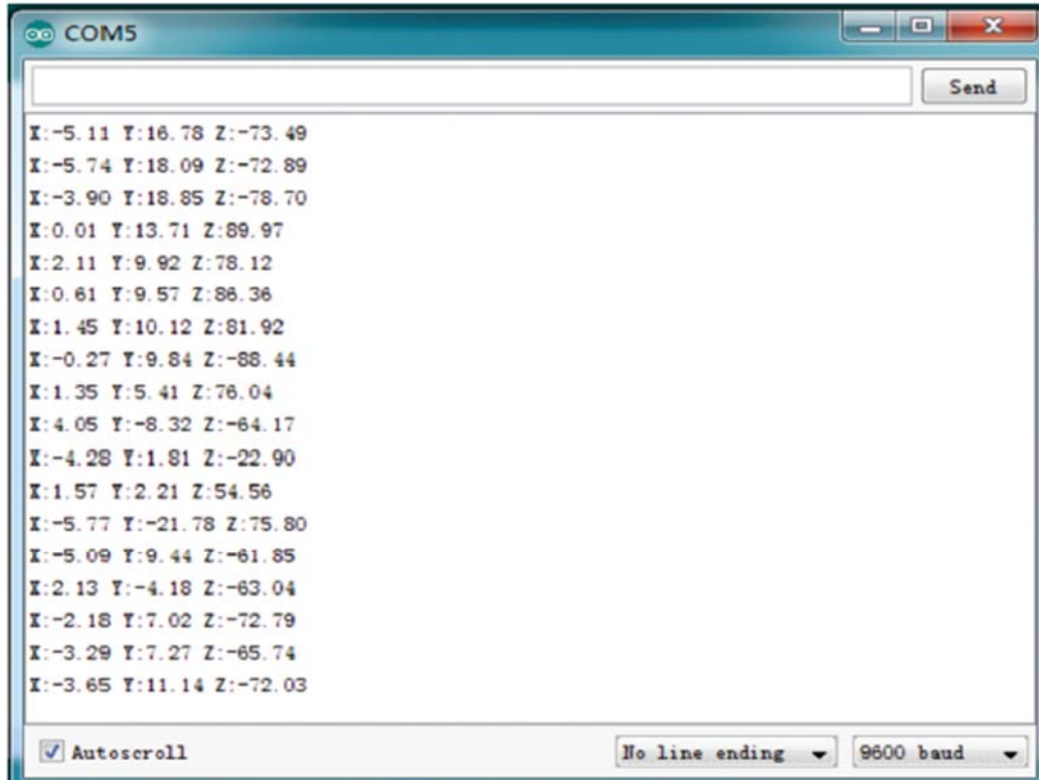

Result from the serial port

- mBlock programming

Me 3-Axis Accelerometer and Gyro Sensor supports the mBlock programming environment and its instructions are introduced as follows:

Programming description	Description
	Parameter 1: Select the coordinate axis Function: Read the angle value of X/Y/Z-axis of Me 3-Axis Accelerometer and Gyro Sensor

The following is the effect to make the panda speaking out the value of X/Y/Z of Me 3-Axis Accelerometer and Gyro Sensor.

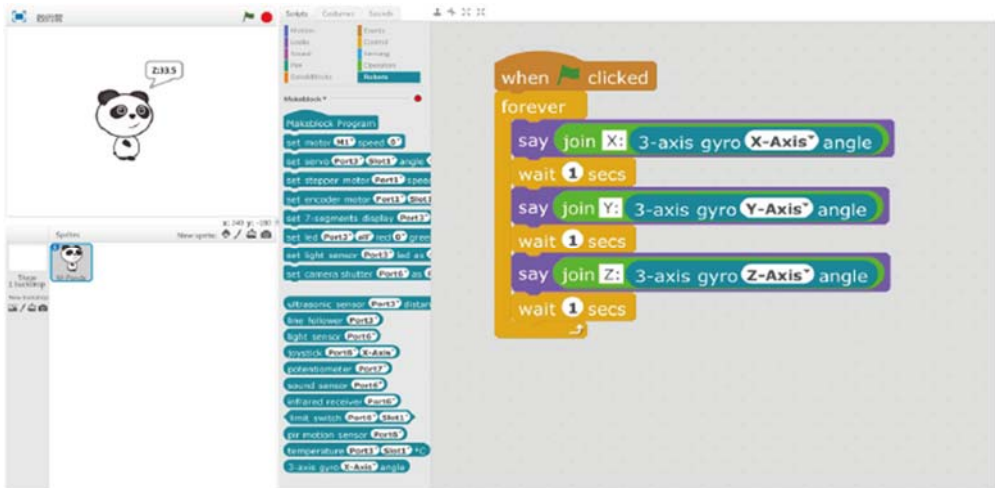
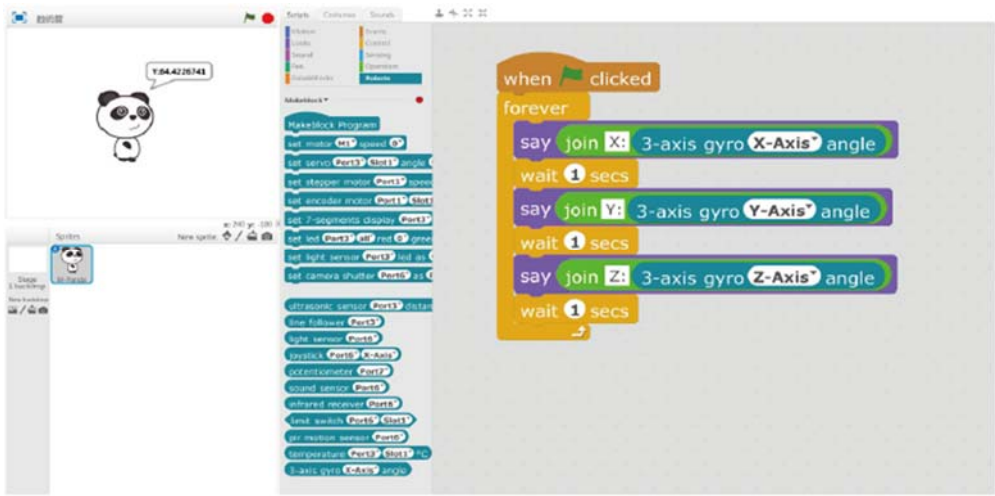

Principle analysis

The Me 3-Axis Accelerometer and Gyro Sensor integrates a 3-axis accelerometer, a 3-axis angular velocity sensor (gyro), and a Digital Motion Processing engine (DMP), and outputs integrated 9-axis synthetical data to application client in the form of single data stream from the I2C port.

The 3-axis accelerometer can measure the change of acceleration in X, Y, and Z axes. By perceiving the total inertial force in a specific direction, the accelerometer can measure the acceleration and gravity. The 3-axis accelerometer means it can detect the motion or gravity of a an object in 3D space. The accelerometer can be used to measure the gravity g. If the module is still and completely motionless, the force that the earth gravity exerts on it is about 1 g. If it is placed vertically, it will detect the force exerting on it along Y-axis is about 1 g. If it is placed at a certain angle, it will detect that the force of 1 g distributes on different axis. When it is in motion or vibration in 3D space, the Me 3-Axis accelerometer and Gyro Sensor will detect the force greater than 1 g in one or more axes, and acceleration as well. Velocity and displacement can be obtained by integrated the acceleration. When an object rotates around an axis, the angular velocity is generated. The 3-axis angular velocity sensor (gyro) can detect the change of angular velocity on X, Y, and Z axes. The motion processing engine can directly output data through I2C port, which reduces the burden of peripheral microprocessor and avoids complicated filtering and data synthesization.

Schematic

