

POS.	A ^{-0.76}	B ^{+0.25}	C	D ^{-0.3}	Part NO.
9	31.19	16.79	25.00 ^{+0.12} _{-0.13}	6.12	241A10050X
15	39.52	25.12	33.30 ^{+0.15} _{-0.1}	6.12	241A10060X
25	53.42	38.84	47.04 ^{±0.13}	5.99	241A10070X
37	69.70	55.30	63.50 ^{±0.13}	5.99	241A10080X

used for: D-SUB FILTER

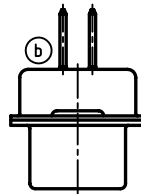
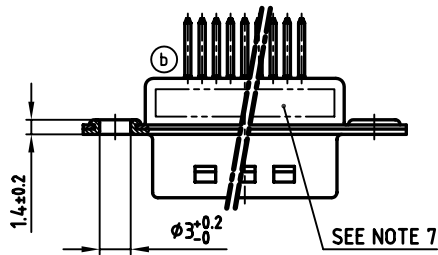
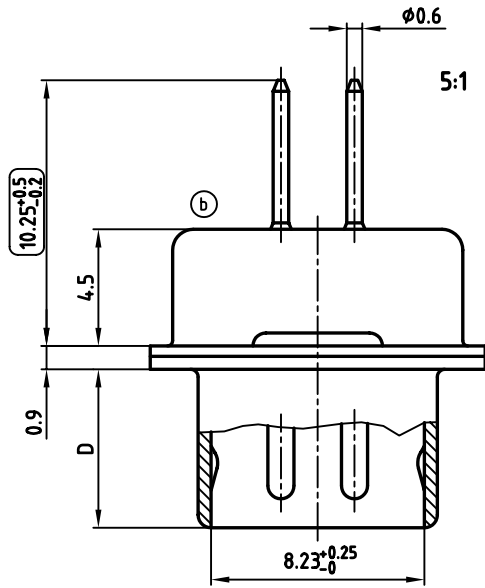
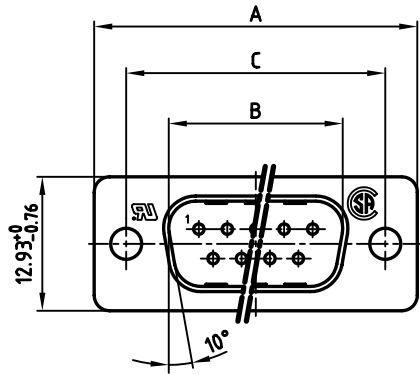

NOTES:

- METALSHELLS: STEEL; min. 320µ" TIN
- INSULATORS: PBT GF UL 94 V-0, BLACK
- CONTACTS: COPPER ALLOY
PLATING: 8µ" HARD GOLD OVER min. 50µ" NICKEL
- P.C.B. HOLE DRILLINGS ON SHEET 2
- CAPACITANCE: 1300pF ±20%
- DIELECTRIC WITHSTANDING VOLTAGE: 424 VDC
- CONNECTOR IS PART MARKED: [PART-NO. CONEC ABC]
- = CHECK DIMENSION

Directive 2002/95/EC
RoHS
Compliant

APPROVAL # FREIGABE # DEBLOCAGE # AUTORIZACION # APPROVAL	
CUSTOMER APPROVAL DATE:	
NAME:	TITLE:
COMPANY NAME:	
APPROVAL # FREIGABE # DEBLOCAGE # AUTORIZACION # APPROVAL	

THIS DRAWING MAY NOT BE COPIED OR REPRODUCED IN ANY WAY, AND MAY NOT BE PASSED ON TO A THIRD PARTY, WITHOUT WRITTEN PERMISSION. OWNERSHIP AND COPYRIGHT OF CONEC GmbH DO NOT ALTER CAD DRAWING BY HAND

rev.	description	date	name
3 x b	Ä 2419	02.01.2006	Lehmen

tolerance		scale:	2:1 (5:1)
	dim. in mm	material:	SEE NOTES
2005	date	name	title:
drawn	18.10.	Lehmenkühler	D-SUB FILTER MALE
appd.	19.10.	Mickenbecker	9-37pos. SOLDER PIN STRAIGHT
norm	DIN 41652		dwg no:
d-old			AutoCAD 2004
CONEC		DIN-A	
		24K1A710	
part no:		SEE TABLE	

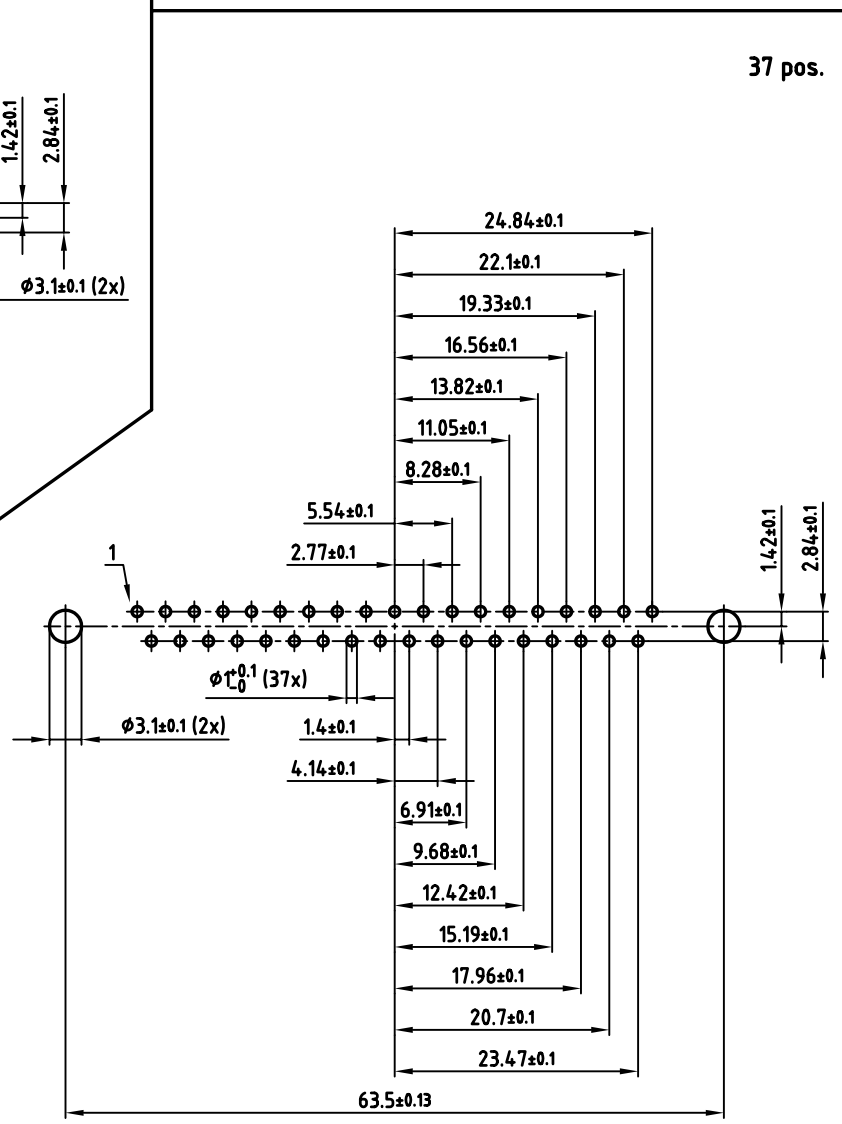
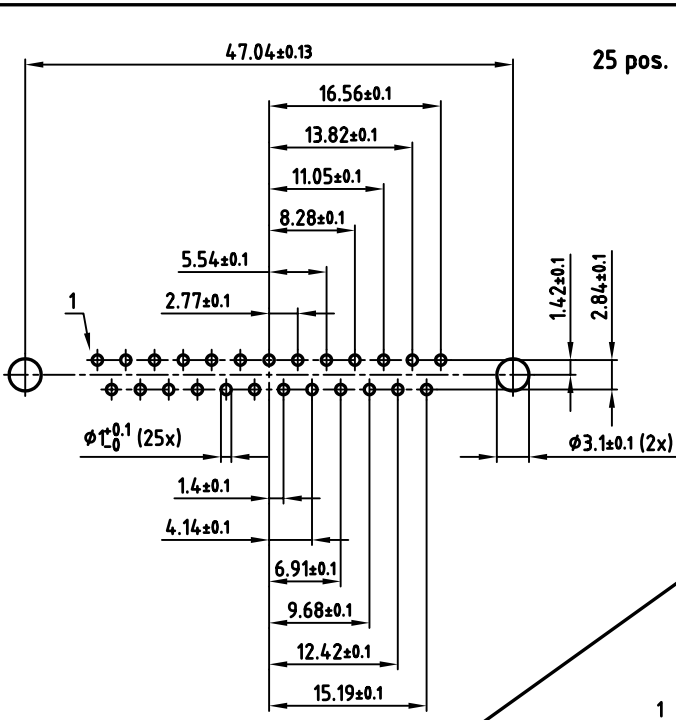
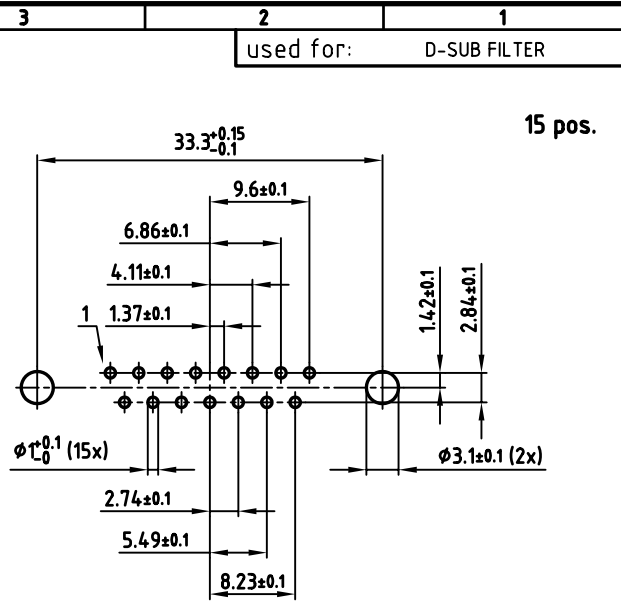
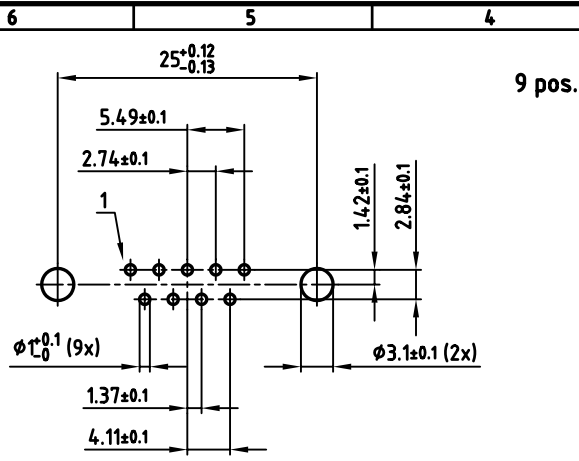

used for: D-SUB FILTER

APPROVAL # FREIGABE # DEBLOCAGE # AUTORIZACION # APPROVAL

CUSTOMER APPROVAL DATE:

NAME: TITLE:

COMPANY NAME:

APPROVAL # FREIGABE # DEBLOCAGE # AUTORIZACION # APPROVAL

THIS DRAWING MAY NOT BE COPIED OR REPRODUCED IN ANY WAY, AND MAY NOT BE PASSED ON TO A THIRD PARTY, WITHOUT WRITTEN PERMISSION. OWNERSHIP AND COPYRIGHT OF CONEC GmbH. DO NOT ALTER CAD DRAWING BY HAND

rev.	description	date	name

tolerance		scale:	2:1
	dim. in mm	material:	SEE SHEET 1
2005	date	name	
drawn	18.10.	Lehmenkühler	
appd.	19.10.	Mickenbecker	
norm	DIN 41652		
d-old			

title: P.C.B. HOLE DRILLINGS
D-SUB FILTER MALE 9-37pos. SOLDER PIN

dwg no: AutoCAD 2004

24K1A710

part no: SEE SHEET 1

DIN-A 3 sh:2/2