

2006
PRODUCT UPDATE

power-one[™]
Changing the Shape of Power



DC-DC Converters

Z-One[™] Digital Power Systems

Infrastructure Power for an On-Demand World

Power-One provides power management and conversion solutions to a diverse array of global customers, including many of the most well-known high-technology companies, as well as thousands of customers serviced through distribution.

High-availability infrastructure applications include wireless communications, routers, optical networking, medical diagnostic, railway, semiconductor-test, and data server/storage equipment.



Data and Voice Communications

Servers and Data Storage

Manufacturing and Test Equipment

Medical Imaging and Diagnostic

Industrial and Railway



Manufacturing capacity can be quickly adjusted to meet customer demands through the coordination of Power-One facilities, joint ventures, and contract manufacturers.

Although each factory is optimized to manufacture specific products and volumes, work cells provide the flexibility to manufacture additional products based on customer location, leadtime requirements, and shipping costs. This combination of strategic locations and flexible infrastructure enables world class responsiveness.

World-Class Support for Global Customers

With strategic presences in the Americas, Europe, and Asia, Power-One is positioned to provide world-class support to global customers. Power-One employs over 2,000 people worldwide and is certified to ISO standards for all facilities, including joint ventures and contract manufacturing partnerships.



Research and Development centers are located in key geographical technology areas to provide access to the industry's best technical talent. In addition to developing precedent-setting products, these satellite R&D locations support global customers at their local facilities, helping to accelerate their time to market.



Final Configuration of power systems and ac-dc products at regional centers reduce costs and leadtimes. Design and build capabilities include:

- Distribution systems including bus bars, fuses, and circuit breakers.
- Complete battery systems.
- Configuration of controllers and communications interfaces.
- Environmentally-controlled outdoor power cabinets.



Reduction of Hazardous Substances (RoHS)

In accordance with the full range of compliance options described in the European Union's RoHS Directive, Power-One is offering products in lead-free and lead-solder-exempted versions. This two-tiered strategy provides customers

with compliance choices that will not be offered by all power-system manufacturers. Please refer to the outside back cover of this brochure, or visit www.power-one.com, for further details.

Power Conversion and Management from AC to IC Any Voltage, Any Current, Any Power Architecture

Power-One's over 2500 products support every step in the management and conversion of utility-grade AC into the low DC voltages required to power high-speed ICs. A unique combination of product breadth and flexibility provides a power solution for virtually any application.

Programmable and modular products can be readily configured to meet many customer requirements. In addition, standard products provide proven platforms for modified and custom solutions.

Board Level

Bricks and POL Converters

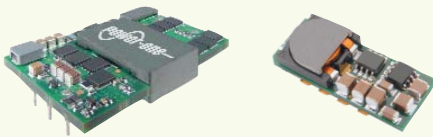

- POLs in industry-standard or high-power-density Power-One footprints deliver 0.7 to 5.5 VDC.
- Fixed-ratio and fully-regulated bricks, 1/8 to full, with up to four outputs from 0.8 to 54.3 VDC
- Power-over-Ethernet (PoE) bricks
- Non-brick isolated products are also available, including extended-temperature-range models.

Z-One Digital IBA

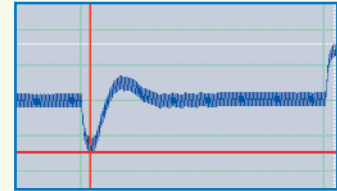

- Hardware-configurable and I²C-programmable models
- Optional wizard-driven graphical user interface
- Dramatically simplified power-system development
- Significantly reduced component count improves reliability, cost, and power density.

System Level

AC-DC Front Ends



- I²C compatible control of outputs from 12 to 48 VDC
- Chassis or hot-swap rack mount
- Up to 525 amps per power shelf
- Single and three-phase inputs

Industrial Products



- CompactPCI, 200 to 500 watts
- Rugged cassette style
- Open-frame linears
- Positive switching regulators
- DIN-rail mount, including battery chargers

Chassis Mount



- Single and multiple output models provide up to 4,000 watts.
- Modular products can be configured with up to 21 outputs.
- Power-over-Ethernet solutions

Site Level

Power System Components



- Rectifiers, controllers, power shelves, primary and secondary distribution cabinets
- Web-enabled PowCom software enables remote reporting and management of multiple DC power systems.

Systems and Cabinets

- Configuration of complete power systems, including batteries and distribution
- Environmentally-controlled outdoor power cabinets
- Nominal 24 or 48V outputs
- Scalability is enabled by hot-swappable rectifiers and modular distribution.





ZM7300 controller manages up to 32 Z-POLs and four analog devices



New SSQ 1/16 brick provides up to 25 amps



QME48 offers industry-leading 70°C performance

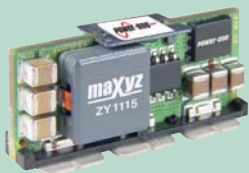

Z-1000 No-Bus POLs provide power management without external controllers



One of the industry's broadest selections of railway and rugged products

DC-DC Non-Isolated POL Converters

	Surface Mount	Through Hole
Z-One Digital IBA Integrates Power Management and Conversion	4	•
Y-Series POLs are available in Industry-Standard and High-Performance Power-One Footprints	6	7

DC-DC Isolated Surface Mount

	1/16 Brick	1/8 Brick	1/4 Brick	Non Brick
Single Output	8	8	9	10
Dual Output	•	•	11	12
Input Filters	•	•	•	9

DC-DC Isolated Through Hole

	1/16 Brick	1/8 Brick	1/4 Brick	1/2 Brick	3/4 Brick	Full Brick	Non Brick
IBA Bus Converters	•	13	13	13	•	13	•
Power over Ethernet	•	•	•	14	•	•	•
Single Output	14	15	16	18	19	19	19
Dual Output	•	•	22	23	23	•	24
Triple Output	•	•	28	•	•	•	29
Quad Output	•	•	•	•	•	•	32
Input Filters	•	•	•	•	•	•	14

DC-DC Chassis Mount and CompactPCI

Chassis Mount- Single, Triple, and Quad Outputs	34
CompactPCI- 200 and 250 Watt Products	59

DC-DC Railway and Rugged

Railway and Rugged Products Overview						35
Positive Switching Regulators						36
Cassette Products	K 38	M 39	S 39	P 40	Q 41	

AC-DC Table of Contents

AC-DC Railway and Rugged

Railway and Rugged Products Overview								35
Cassette Products	M 42	H 42	S 43	S/PFC 43	K 44	K/PFC 44	KP/PFC 44	
DIN-Rail Mount	LOK, LOR, LOS Series							45
	W Series with PFC							45
	X Series with PFC							46
	Battery Chargers							46

AC-DC Chassis Mount Linears and Switchers

Open Frame Linear	Single Output		47	
	Dual Output		48	
	Triple Output		49	
Board-only, U-Channel, and Enclosed Switchers	Single Output		50	
	Dual Output		52	
	Triple Output		52	
	Quad Output	Under 100 Watts		54
		110 to 125 Watts		55
		130 to 150 Watts		56
200 to 250 Watts		57		
375 to 400 Watts		58		
Configurable Modular	ESP Series- Up to 12 Outputs		62	
	ESM Series- Up to 12 Outputs, Medical Approvals		62	
	High Power- Up to 21 Outputs, 1000 to 4000 Watts		64	

AC-DC Hot Swap, CompactPCI, and PoE

CompactPCI- 200 to 500 Watts	59
Power over Ethernet	59
Hot-Swap Front Ends	60
Power Shelves	61
Rectifiers and Power Systems	Please visit www.power-one.com

Nuclear and Medical Applications— Power-One products are not designed, intended for use in, or authorized for use as critical components in life support systems, equipment used in hazardous environments, or nuclear control systems without the express written consent of the respective divisional president of Power-One, Inc.

Technical Revisions— The appearance of products, including safety agency certifications pictured on labels, may change depending on the date manufactured. Specifications are subject to change without notice.



FNP600 offers extensive I²C interface capabilities



BLP products are ideal solutions for 1U applications



FNP1800 front ends deliver over 18.3 watts/cubic inch



DIN-Rail products are available in converter and battery charger configurations



PODS16 outdoor power systems utilize 93.5% efficient rectifiers

A Digital Power Management Architecture for Every Application



With products ranging from the No-Bus™ Z-1000 Point-Of-Load (POL) converters to the I²C programmable Z-7000 Series, Z-One™ Digital IBA can provide the advantages of integrated power management and conversion to any application. In addition to the overview information presented on these two pages, please see page six for model listings.



Z-One™ Digital IBA		No-Bus™ Z-1000 POLs	Z-7000 POLs and Digital Power Manager (DPM)
Power Management	Interface	Hardware configurable	I ² C programmable
	Features	No external controller or bus required	DPM provides unprecedented power management options
Parameter Selection	What	<ul style="list-style-type: none"> ■ Vout ■ Turn-on delays ■ Feedback loop compensation ■ Interleave 	<ul style="list-style-type: none"> ■ Vout and turn-on delays ■ Feedback loop compensation ■ Interleave ■ Protections ■ Power Good ■ Fault management ■ Slew rates ■ Frequency ■ Up to four analog components
	How	Pin strapping and only one trim resistor and capacitor	I ² C programming capabilities include a wizard-driven GUI
Telemetry	What	Current and temperature	Voltage, current, and temperature
	How	Digital and analog signals	Via I ² C bus

The Industry's First Multi-Source Digital Power Products

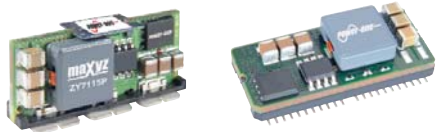
Power-One firmly believes that customers should have choices and has a licensing agreement with C&D Technologies that provides customers, for the first time ever, with multiple-source products that utilize digital feedback loops and digital Pulse Width Modulation (PWM) controllers. These true digital products provide a unique combination of value, performance, and power management options.

	Z-1000 and Z-7000 POL Converters	ZM-7000 Digital Power Managers (DPMs)
Packages	 <p>Vertical and Horizontal SMT</p>	 <p>ZM7300 Digital Power Manager</p>
Input Voltage	User defined from 3 to 14VDC	<ul style="list-style-type: none"> ■ Programs, controls, and monitors up to 32 Z-7000 POLs and up to four analog devices. ■ Ensures data integrity by storing configuration instructions in non-volatile memory. ■ Collects Z-7000 POL performance data (output voltage, output current, and temperature). ■ Monitors the intermediate bus, accepts interrupts, initiates crowbar protection, and interfaces with dc-dc bus converters and ac-dc front ends.
Output Voltage	User defined from 0.5 to 5.5V	
Current Ratings	Ranges of 5 to 20 amp models extended by current share capabilities	
Current Density	20A POL provides 50A/in ² from a 0.4 in ² footprint	
Migration Paths	Common Z-1000 and Z-7000 footprints simplify power system migrations	
Customizations	The silicon-based technologies that provide Z-One Digital IBA with unprecedented power-management capabilities can be readily adapted to meet the needs of specific applications. Please contact your Power-One representative to discuss how this proven-technology approach can be cost-effectively implemented to address your custom point of load requirements.	

Z-1000 No-Bus™ POLs, No Controllers, No Programming

No-Bus™ Z-1000 POLs provide sophisticated power management capabilities without the cost and complexity of third-party controllers and the communication bus interfaces required by analog architectures. Please see page six for model listing information.

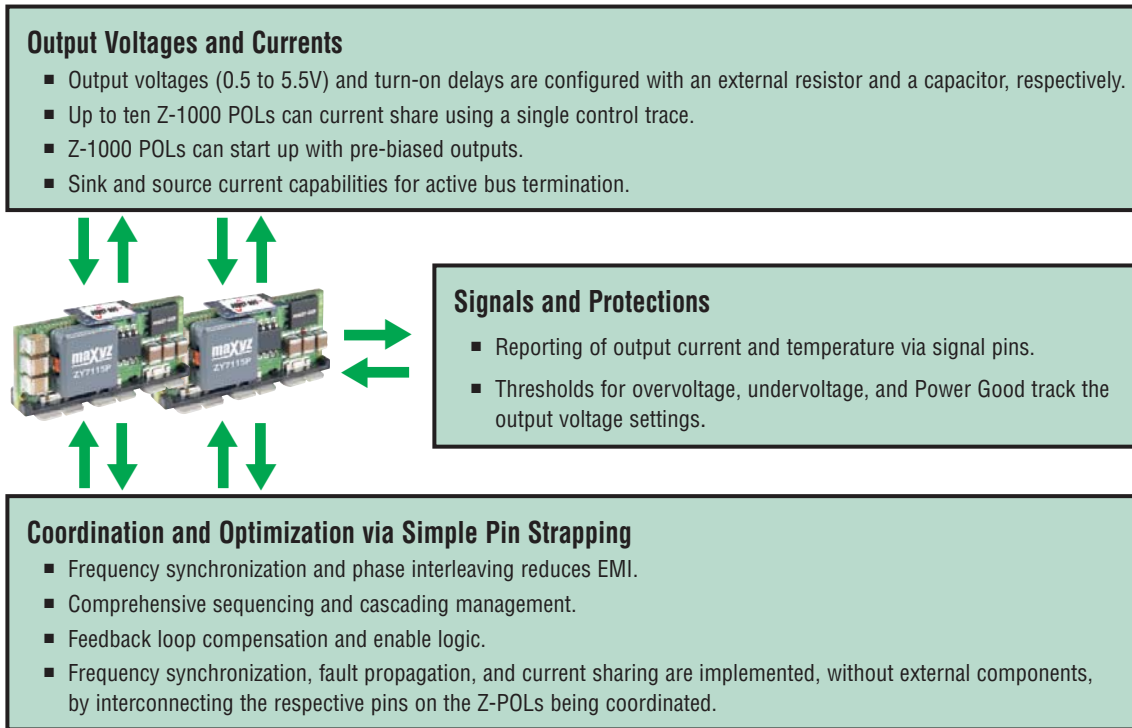

Z-7000 Series Reduces Power System Components, Traces, and Development Time by 90%

The Z-7000 Series combines many innovative operating concepts to achieve an unprecedented level of power-system integration. A multitude of parameters, such as output voltages, sequencing, tracking, and protection limits are user-programmed through a Graphical User Interface (GUI) and stored in a Digital Power Manager (DPM). Unlike other power management solutions it does not require users to provide an I²C interface, host processor, or non-volatile memory – Z-One™ Digital IBA operates autonomously in any system. Please see page six for model listing information.

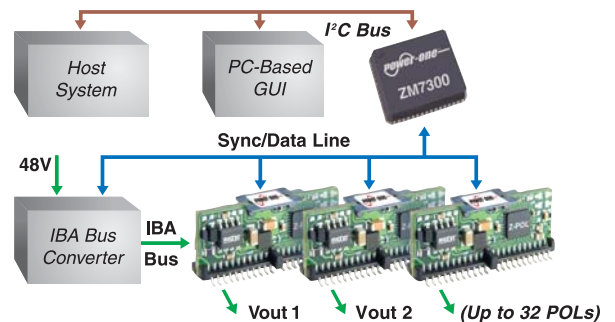

- Open architecture based on industry standard I²C interface.
- Extremely scalable architecture provides up to 32 programmable outputs from 0.5 to 5.5VDC.
- Significant reduction in the number of unique models in inventory.
- Reduced component count improves cost, reliability, and power density.
- GUI-driven configuration and simulation simplifies power system development, accelerating time to market.
- Fully-integrated solution eliminates component incompatibility issues.
- Manages up to four analog components including VRMs, POLs, fans, and linear regulators.



ZM7300 Digital Power Manager

- Controls up to 32 Z-7000 POLs and 4 analog components
- Compact 9 x 9 mm package



ZY11XX & ZY71XX

1.25 x 0.55 x 0.31 inch
32 x 14 x 8 mm

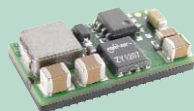

ZY7007, ZY1207, & ZY1210

0.87 x 0.49 x 0.26 inch
22.2 x 12.5 x 6.5 mm



ZY7010 & ZY1015

1.25 x 0.55 x 0.28 inch
32 x 14 x 7.1 mm



Y5117PC

1.26 x 0.55 x 0.31 inch
32 x 14 x 7.9 mm

Z-7000 Series POLs

Input Voltage (VDC)	Factory Set Vout (VDC)	Vout Program (VDC)	Max Output Current (Amps)	Model
3 to 14	0.5	0.5 to 5.5	7	ZY7007
3 to 14	0.5	0.5 to 5.5	10	ZY7010
3 to 14	0.5	0.5 to 5.5	15	ZY7015
3 to 14	0.5	0.5 to 5.5	15	ZY7115
3 to 14	0.5	0.5 to 5.5	20	ZY7120

Z-7000 Series Digital Power Managers

Model Number	Digital POL Management Nodes	Analog Component Management Nodes	Combined Nodes*
ZM7304	4	4	4
ZM7308	8	4	8
ZM7316	16	4	16
ZM7332	32	4	32

* Combined nodes are the maximum number of analog and digital components that can be concurrently managed.

Z-1000 Series No-Bus™ POLs

Input Voltage (VDC)	Factory Set Vout (VDC)	Vout Trim (VDC)	Max Output Current (Amps)	Model
3 to 14	0.5	0.5 to 5.5	7	ZY1207
3 to 14	0.5	0.5 to 5.5	10	ZY1210
3 to 14	0.5	0.5 to 5.5	15	ZY1015
3 to 14	0.5	0.5 to 5.5	15	ZY1115
3 to 14	0.5	0.5 to 5.5	20	ZY1120

Y-Series Surface-Mount POL Converters

Input Voltage (VDC)	Factory Set Vout (VDC)	Vout Trim (VDC)	Max Output Current (Amps)	Model
5.5Vin and Lower				
3 to 5.5	0.75	0.75 to 3.63	5	YM05S05
3 to 5.5	0.75	0.75 to 3.63	6	YNM05S06
3 to 5.5	0.75	0.75 to 3.63	10	YS05S10
3 to 5.5	0.75	0.75 to 3.63	16	YS05S16
4.5 to 5.5	0.75	0.75 to 3.63	20	YNC05S20
3 to 5.5	0.9	0.85 to 0.99	10	YNL05S10009
3 to 5.5	1	0.9 to 1.1	10	YNL05S10010
3 to 5.5	1.2	1.1 to 1.3	10	YNL05S10012
3 to 5.5	1.5	1.4 to 1.6	10	YNL05S10015
3 to 5.5	1.8	1.7 to 1.9	10	YNL05S10018
3 to 5.5	2	1.8 to 2.2	10	YNL05S10020
3 to 5.5	2.5	2.3 to 2.7	10	YNL05S10025
3 to 5.5	3.3	3 to 3.6	10	YNL05S10033
3 to 13.2Vin				
3 to 13.2	0.7	0.7 to 3.63	17	Y5117PC

DC-DC > POL Management and Conversion

Y-Series Surface-Mount POL Converters (continued)

Input Voltage (VDC)	Factory Set Vout (VDC)	Vout Trim(VDC)	Max Output Current (Amps)	Model
9.6 to 14Vin				
9.6 to 14	0.75	0.75 to 5.5	5	YM12S05
9.6 to 14	0.75	0.75 to 5.5	10	YS12S10
9.6 to 14	0.75	0.75 to 5.5	16	YS12S16
9.6 to 14	0.75	0.75 to 5.5	20	YNC12S20
9.6 to 14	1	0.9 to 1.1	10	YNL12S10010
9.6 to 14	1.2	1.1 to 1.3	10	YNL12S10012
9.6 to 14	1.5	1.4 to 1.6	10	YNL12S10015
9.6 to 14	1.8	1.7 to 1.9	10	YNL12S10018
9.6 to 14	2	1.8 to 2.2	10	YNL12S10020
9.6 to 14	2.5	2.3 to 2.7	10	YNL12S10025
9.6 to 14	3.3	3 to 3.6	10	YNL12S10033
9.6 to 14	5	4.5 to 5.5	10	YNL12S10050



YM05S, YM12S, & YNM05S

0.8 x 0.45 x 0.25 inch
20.3 x 11.4 x 6.3 mm



YNC, YNL, & YS

1.30 x 0.53 x 0.31 inch
33 x 13.5 x 8 mm

Y-Series Through-Hole POL Converters

Input Voltage (VDC)	Factory Set Vout (VDC)	Vout Trim (VDC)	Max Output Current (Amps)	Model
5.5Vin and Lower				
3 to 5.5	0.75	0.75 to 3.63	6	YNV05T06
3 to 5.5	0.75	0.75 to 3.63	10	YNV05T10
3 to 5.5	0.75	0.75 to 3.63	16	YNV05T16
3 to 5.5	0.9	0.85 to 0.99	10	YNV05T10009
3 to 5.5	1	0.9 to 1.1	10	YNV05T10010
3 to 5.5	1.2	1.1 to 1.3	10	YNV05T10012
3 to 5.5	1.5	1.4 to 1.6	10	YNV05T10015
3 to 5.5	1.8	1.7 to 1.9	10	YNV05T10018
3 to 5.5	2	1.8 to 2.2	10	YNV05T10020
3 to 5.5	2.5	2.3 to 2.7	10	YNV05T10025
3 to 5.5	3.3	3 to 3.6	10	YNV05T10033
6 to 14Vin				
6 to 14	0.75	0.75 to 5.5	6	YT09T06-0P
6 to 14	0.75	0.75 to 5.5	10	YT09T10-0P
6 to 14	0.75	0.75 to 5.5	16	YT09T16-0P
9.6 to 14Vin				
9.6 to 14	0.75	0.75 to 5.5	5	YNV12T05
9.6 to 14	0.75	0.75 to 5.5	10	YNV12T10
9.6 to 14	0.75	0.75 to 5.5	16	YNV12T16
9.6 to 14	1	0.9 to 1.1	10	YNV12T10010
9.6 to 14	1.2	1.1 to 1.3	10	YNV12T10012
9.6 to 14	1.5	1.4 to 1.6	10	YNV12T10015
9.6 to 14	1.8	1.7 to 1.9	10	YNV12T10018
9.6 to 14	2	1.8 to 2.2	10	YNV12T10020
9.6 to 14	2.5	2.3 to 2.7	10	YNV12T10025
9.6 to 14	3.3	3 to 3.6	10	YNV12T10033
9.6 to 14	5	4.5 to 5.5	10	YNV12T10050



YNV05T06 & YNV12T05

0.90 x 0.40 x 0.21 inch
22.9 x 10.2 x 5.4 mm

YT09T06

1.0 x 0.5 x 0.27 inch
25.4 x 12.7 x 6.9 mm

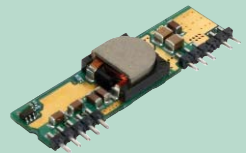

YNV05T10, YNV05T10XXX, YNV05T16, YNV12T10, YNV12T10XXX, & YNV12T16

2.0 x 0.54 x 0.28 inch
50.8 x 13.6 x 7.1 mm

YT09T10, YT09T16

2.0 x 0.5 x 0.32 inch
50.8 x 12.7 x 8.1 mm



SSQ48S

1.3 x 0.9 x 0.34 inch
33 x 22.9 x 8.51 mm

- Provides Up to 50W
- Isolated Output (Basic insulation per EN60950)
- Industry-Standard DOSA compliant package

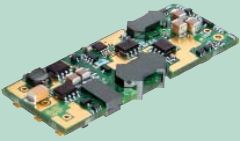

SQ24S

2.30 x 0.90 x 0.26 inch
58.4 x 22.8 x 6.6 mm

- 15 to 50 Watts (Up to 15A)
- Industry-Standard Surface Mount, Quarter-Brick Pinout
- Low Profile: 0.26" (6.6mm)
- High Efficiency (No Heat Sink Required)

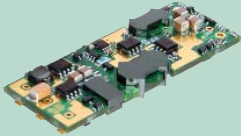

SQ48S

2.30 x 0.90 x 0.26 inch
58.4 x 22.8 x 6.6 mm

- Delivers Up to 15A (50 W)
- Industry-Standard Surface Mount, Quarter-Brick Pinout
- Low Profile: 0.26" (6.6mm)
- No Minimum Load



SQM48S

2.30 x 0.90 x 0.28 inch
58.4 x 22.8 x 7.1 mm

- 24 to 66 Watts (Up to 25A)
- Industry-Standard Surface Mount, Quarter-Brick Pinout
- High Efficiency (No Heat Sink Required)

www.power-one.com

DC-DC > Surface Mount > Single-Output > 1/16-Brick

Unsigned output voltages are isolated and can be used as either + or - polarities.

Input Voltage (VDC)	Factory Set Vout (VDC)	Output Voltage Trim (VDC)	Max Current (Amps)	Model
36 to 75	1.2	1.0 to 1.3	25	SSQ48S25012
36 to 75	1.5	1.2 to 1.6	25	SSQ48S25015
36 to 75	1.8	1.4 to 1.9	25	SSQ48S25018
36 to 75	2.5	2 to 2.7	20	SSQ48S20025
36 to 75	3.3	2.6 to 3.6	15	SSQ48S15033
36 to 75	5	4 to 5.5	10	SSQ48S10050

DC-DC > Surface Mount > Single-Output > 1/8-Brick

Input Voltage (VDC)	Factory Set Vout (VDC)	Vout Trim (VDC)	Max Current (Amps)	Model
Nominal 24Vin				
18 to 36	1	0.9 to 1.1	15	SQ24S15010
18 to 36	1.2	1.1 to 1.3	15	SQ24S15012
18 to 36	1.5	1.2 to 1.6	15	SQ24S15015
18 to 36	1.8	1.5 to 1.9	15	SQ24S15018
18 to 36	2	1.6 to 2.2	15	SQ24S15020
18 to 36	2.5	2 to 2.7	15	SQ24S15025
18 to 36	3.3	2.7 to 3.6	15	SQ24S15033
18 to 36	5	4 to 5.5	10	SQ24S10050
18 to 36	6	4.8 to 6.6	8	SQ24S08060
18 to 36	8	6.4 to 8.8	5.3	SQ24S05080
18 to 36	12	9.6 to 13.2	4	SQ24S04120
19 to 36	15	12 to 16.5	3.3	SQ24S03150
Nominal 48Vin				
36 to 75	1	0.9 to 1.1	15	SQ48S15010
36 to 75	1.2	1.1 to 1.3	15	SQ48S15012
36 to 75	1.2	1.1 to 1.3	20	SQM48S20012
36 to 75	1.2	1.1 to 1.3	25	SQM48S25012
36 to 75	1.5	1.2 to 1.6	15	SQ48S15015
36 to 75	1.5	1.2 to 1.6	20	SQM48S20015
36 to 75	1.5	1.2 to 1.6	25	SQM48S25015
36 to 75	1.8	1.5 to 1.9	15	SQ48S15018
36 to 75	1.8	1.5 to 1.9	20	SQM48S20018
36 to 75	1.8	1.5 to 1.9	25	SQM48S25018
36 to 75	2	1.6 to 2.2	15	SQ48S15020
36 to 75	2	1.6 to 2.2	20	SQM48S20020
36 to 75	2	1.6 to 2.2	25	SQM48S25020
36 to 75	2.5	2 to 2.7	15	SQ48S15025
36 to 75	2.5	2 to 2.7	20	SQM48S20025
36 to 75	2.5	2 to 2.7	25	SQM48S25025
36 to 75	3.3	2.7 to 3.6	15	SQ48S15033
36 to 75	3.3	2.7 to 3.6	20	SQM48S20033
36 to 75	5	4 to 5.5	10	SQ48S10050
36 to 75	6	4.8 to 6.6	8	SQ48S08060
36 to 75	8	8.4 to 8.8	5.3	SQ48S05080
36 to 75	12	9.6 to 13.2	4	SQ48S04120

DC-DC > Surface Mount > Single-Output > 1/4-Brick

Unsigned output voltages are isolated and can be used as either + or - polarities.

Input Voltage (VDC)	Factory Set Vout (VDC)	Vout Trim (VDC)	Max Current (Amps)	Model
Nominal 24Vin				
18 to 36	1.5	1.2 to 1.6	25	Q24S25015
18 to 36	1.5	1.2 to 1.6	30	Q24S30015
18 to 36	1.8	1.5 to 1.9	25	Q24S25018
18 to 36	1.8	1.5 to 1.9	30	Q24S30018
18 to 36	2	1.6 to 2.2	25	Q24S25020
18 to 36	2	1.6 to 2.2	30	Q24S30020
18 to 36	2.5	2 to 2.7	25	Q24S25025
18 to 36	2.5	2 to 2.7	30	Q24S30025
18 to 36	3.3	2.7 to 3.6	25	Q24S25033
18 to 36	3.3	2.7 to 3.6	30	Q24S30033
18 to 36	5	4 to 5.5	15	Q24S15050
Nominal 48Vin				
36 to 75	0.8	0.8	30	QL48S30008
36 to 75	1	0.9 to 1.1	30	QL48S30010
36 to 75	1	0.9 to 1.1	40	QM48S40010
36 to 75	1.2	1.1 to 1.3	30	QL48S30012
36 to 75	1.2	1.1 to 1.4	40	QM48S40012
36 to 75	1.5	1.2 to 1.6	25	Q48S25015
36 to 75	1.5	1.2 to 1.6	30	Q48S30015
36 to 75	1.5	1.2 to 1.6	40	QM48S40015
36 to 75	1.8	1.5 to 1.9	25	Q48S25018
36 to 75	1.8	1.5 to 1.9	30	Q48S30018
36 to 75	1.8	1.5 to 1.9	40	QM48S40018
36 to 75	2	1.6 to 2.2	25	Q48S25020
36 to 75	2	1.6 to 2.2	30	Q48S30020
36 to 75	2	1.6 to 2.2	40	QM48S40020
36 to 75	2.5	2 to 2.7	25	Q48S25025
36 to 75	2.5	2 to 2.7	30	Q48S30025
36 to 75	2.5	2 to 2.7	40	QM48S40025
36 to 75	3.3	2.7 to 3.6	25	Q48S25033
36 to 75	3.3	2.7 to 3.6	30	Q48S30033
36 to 75	3.3	2.7 to 3.6	40	QM48S40033
36 to 75	5	4 to 5.5	15	Q48S15050
36 to 75	5	4 to 5.5	20	Q48S20050
36 to 75	5	4 to 5.5	25	QM48S25050
36 to 75	12	9.6 to 13.2	8	Q48S08120
36 to 75	12	9.6 to 13.2	14	QM48S14120

DC-DC > Surface Mount > Input Filters

Max Current (Amps)	Voltage (VDC)	Mounting	Meets Conducted	Part Number
4	80	SMT	FCC Class B	F4804
10	50	SMT	FCC Class B	F2410
10	100	SMT	FCC Class B	F4810

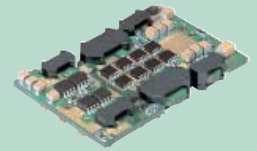

Q24S & Q48S

2.30 x 1.45 x 0.26 inch
58.4 x 36.8 x 6.6 mm

- 24 to 100 Watts (Up to 30A)
- Industry-Standard Surface Mount, Quarter-Brick Pinout
- Low Profile: 0.26" (6.6mm)
- High Efficiency (No Heat Sink Required)

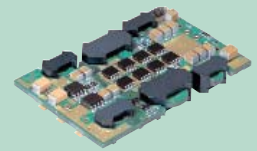

QL48S

2.30 x 1.45 x 0.26 inch
58.4 x 36.8 x 6.6 mm

- 24 to 36 Watts (Down to 0.8V)
- Industry-Standard Surface Mount, Quarter-Brick Pinout
- Low Profile: 0.26" (6.6mm)
- High Efficiency (No Heat Sink Required)

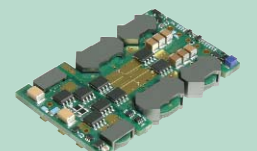

QM48S

2.30 x 1.45 x 0.28 inch
58.4 x 36.8 x 7.1 mm

- Delivers Up to 40A (132W)
- Industry-Standard Surface Mount, Quarter-Brick Pinout
- Low Profile: 0.28"
- High Efficiency (No Heat Sink Required)
- Remote Output Sense

DC-DC > Surface Mount > Single-Output > Non-Brick

Unsigned output voltages are isolated and can be used as either + or - polarities.



NDS

1.30 x 0.91 x 0.33 inch
33 x 23 x 8.5 mm

- 4 to 10 Watts
- Single Outputs, 1.5 to 5 VDC
- 1500 VDC Isolation
- Remote On/Off



NVS

1.30 x 0.81 x 0.33 inch
33 x 20.6 x 8.5 mm

- 4 to 6 Watts
- Single/Dual Outputs
- 1500 VDC Isolation
- Operation from -40 to 85°C



QD48S

2.30 x 1.45 x 0.26 inch
58.4 x 36.8 x 6.6 mm

- Independently-Regulated Outputs
- Minimal Cross-Channel Interference
- Startup into Pre-biased Outputs
- Industry Standard Footprint & Pinout

Input Voltage (VDC)	Factory Set Vout (VDC)	Vout Trim (VDC)	Max Current (Amps)	Model
9 to 36Vin				
9 to 36	3.3	3.3	0.9	NVS0.9CE-M6
9 to 36	5	5	0.7	NVS0.7CG-M6
9 to 36	12	12	0.3	NVS0.3CH-M6
9 to 36	15	15	0.3	NVS0.3CJ-M6
18 to 36Vin				
18 to 36	5	5	1	NVS01YG-M6
18 to 36	12	12	0.5	NVS0.5YH-M6
18 to 36	15	15	0.4	NVS0.4YJ-M6
Ultra-Wide Input				
18 to 75	3.3	3.3	0.9	NVS0.9EE-M6
18 to 72	3.3	2.7 to 3.8	1.5	RNS01EE-M6
18 to 75	5	5	0.7	NVS0.7EG-M6
18 to 72	5.1	4.3 to 5.9	1.2	RNS01EG-M6
18 to 72	7	6 to 8	0.9	RNS0.9ET-M6
18 to 75	12	12	0.3	NVS0.3EH-M6
18 to 75	15	15	0.3	NVS0.3EJ-M6
Nominal 48Vin, 1.5 to 2.5Vout				
36 to 75	1.5	1.4 to 1.6	3	NDS03ZA-M6
36 to 75	1.5	1.4 to 1.7	6	RFS06ZA-M6
36 to 75	1.8	1.7 to 1.9	3	NDS03ZB-M6
36 to 75	1.8	1.6 to 1.9	6	RFS06ZB-M6
36 to 75	2.5	2.3 to 2.7	3	NDS03ZD-M6
36 to 75	2.5	2.3 to 2.7	6	RFS06ZD-M6
Nominal 48Vin, 3.3 to 15Vout				
36 to 75	3.3	3 to 3.6	3	NDS03ZE-M6
38 to 75	3.3	2.3 to 4	3	RNS03ZE-M6
36 to 75	3.3	3 to 3.6	5	RDS05ZE-M6
36 to 75	3.3	2.9 to 3.6	6	RFS06ZE-M6
36 to 72	3.3	3 to 3.6	13	SFS13ZE-M6
36 to 75	5	5	1	NVS01ZG-M6
36 to 75	5	4.5 to 5.5	2	NDS02ZG-M6
36 to 75	5	4.5 to 5.5	4	RDS04ZG-M6
36 to 75	5	4.5 to 5.5	4	RFS04ZG-M6
36 to 72	5	4.5 to 5.5	8	SFS08ZG-M6
38 to 75	5.1	4 to 6	2	RNS02ZG-M6
36 to 75	12	12	0.5	NVS0.5ZH-M6
38 to 75	12	9 to 15	0.6	RNS0.6ZH-M6
36 to 75	15	15	0.4	NVS0.4ZJ-M6

DC-DC > Surface Mount > Dual-Output > 1/4-Brick

Unsigned output voltages are isolated and can be used as either + or - polarities.

Input Voltage (VDC)	Factory Set Vout (VDC)	Vout Trim (VDC)	Max Current (Amps)	Power (Watts)	Model
Nominal 48Vin					
36 to 75	+1.2	1.1 to 1.3,	15	41	QD48S012015
	+1.5	1.4 to 1.7	15		
36 to 75	+1.2	1.1 to 1.3	15	56	QD48S012025
	+2.5	2.3 to 2.8	15		
36 to 75	+1.2	1.1 to 1.3	15	68	QD48S012033
	+3.3	3 to 3.6	15		
36 to 75	+1.5	1.4 to 1.7	15	50	QD48S015018
	+1.8	1.6 to 2	15		
36 to 75	+1.5	1.4 to 1.7	15	60	QD48S015025
	+2.5	2.3 to 2.8	15		
36 to 75	+1.5	1.4 to 1.7	15	72	QD48S015033
	+3.3	3 to 3.6	15		
36 to 75	+1.5	1.4 to 1.7	15	73	QD48S015050
	+5	4.5 to 5.5	10		
36 to 75	+1.8	1.6 to 2	15	65	QD48S018025
	+2.5	2.3 to 2.8	15		
36 to 75	+1.8	1.6 to 2	15	77	QD48S018033
	+3.3	3 to 3.6	15		
36 to 75	+1.8	1.6 to 2	15	77	QD48S018050
	+5	4.5 to 5.5	10		
36 to 75	+2.5	2.3 to 2.8	15	87	QD48S025033
	+3.3	3 to 3.6	15		
36 to 75	+3.3	3 to 3.6	15	100	QD48S033050
	+5	4.5 to 5.5	10		

Check distributor inventory on-line!

Enter partial or full part number above

- North America
- Europe/Asia

www.power-one.com

Alpha-sorted graphics and dimensions augment model listings from both pages.



RDS

1.87 x 1.00 x 0.33 inch
47.4 x 25.4 x 8.4 mm

- 10 to 20 Watts
- 1500 VDC Isolation
- Operation to 85°C



RFS

1.87 x 1.00 x 0.37 inch
47.4 x 25.4 x 9.5 mm

- 9 to 20 Watts
- Single Outputs, 1.5 to 5 VDC
- 1500 VDC Isolation
- Remote On/Off



RNS

1.87 x 1.00 x 0.34 inch
47.4 x 25.4 x 8.5 mm

- 5 to 10 Watts
- 1500 VDC Isolation
- Operation to 85°C
- Wide Input Range



SFS

2.00 x 1.28 x 0.32 inch
50.8 x 32.5 x 8.2 mm

- 20 to 40 Watts
- Single Outputs, 1.5 to 5 VDC
- 1500 VDC Isolation
- Remote On/Off

DC-DC > Surface Mount > Dual-Output > Non-Brick

Unsigned output voltages are isolated and can be used as either + or - polarities.



FBC

4.60 x 2.40 x 0.50 inch
116.8 x 61.0 x 12.7 mm



HBC, HBCS, HDS, & HKS

2.40 x 2.28 x 0.50 inch
61.0 x 57.9 x 12.7 mm



NVD

1.30 x 0.81 x 0.33 inch
33.0 x 20.6 x 8.5 mm



QBC

2.28 x 1.45 x 0.43 inch
57.9 x 36.8 x 11 mm



QKS

2.28 x 1.45 x 0.50 inch
57.9 x 36.8 x 12.7 mm

Input Voltage (VDC)	Factory Set Vout (VDC)	Output Voltage Trim (VDC)	Max Current (Amps)	Power (Watts)	Model
9 to 36Vin					
9 to 36	+5	N/A	0.3	3.5	NVD0.7CGG-M6
	-5	N/A	0.3		
9 to 36	+12	N/A	0.2	4	NVD0.3CHH-M6
	-12	N/A	0.2		
9 to 36	+15	N/A	0.1	4.2	NVD0.3CJJ-M6
	-15	N/A	0.1		
9 to 36	+24	N/A	0.1	3.8	NVD0.2CKK-M6
	-24	N/A	0.1		
18 to 36Vin					
18 to 36	+5	N/A	0.5	5	NVD01YGG-M6
	-5	N/A	0.5		
18 to 36	+12	N/A	0.2	6	NVD0.5YHH-M6
	-12	N/A	0.2		
18 to 36	+15	N/A	0.2	6	NVD0.4YJJ-M6
	-15	N/A	0.2		
Ultra-Wide Input					
18 to 75	+5	N/A	0.3	3.5	NVD0.7EGG-M6
	-5	N/A	0.3		
18 to 75	+12	N/A	0.2	4	NVD0.3EHH-M6
	-12	N/A	0.2		
18 to 75	+15	N/A	0.1	4.2	NVD0.3EJJ-M6
	-15	N/A	0.1		
18 to 75	+24	N/A	0.1	3.8	NVD0.2EKK-M6
	-24	N/A	0.1		
Nominal 48Vin					
38 to 75	+3.3	2.8 to 3.8	1	8.5	RND02ZGE-M6
	+5.2	4.4 to 5.9	1		
36 to 75	+5	N/A	0.5	5	NVD01ZGG-M6
	-5	N/A	0.5		
38 to 75	+5.1	4 to 7	1	10.2	RND02ZGG-M6
	-5.1	4 to 7	1		
36 to 75	+12	N/A	0.2	6	NVD0.5ZHH-M6
	-12	N/A	0.2		
38 to 75	+12	9 to 15	0.4	10	RND0.8ZHH-M6
	-12	9 to 15	0.4		
36 to 75	+15	N/A	0.2	6	NVD0.4ZJJ-M6
	-15	N/A	0.2		

96% Efficient QTS Provides 300 Watts



The QTS incorporates a low-component-count 4:1 proportional ratio topology that reduces cost and increases reliability.

- 2000 VDC Input-to-Output Isolation
- 258 Watts Available at 70°C with 200 LFM Cooling
- Low Conducted and Radiated EMI
- Start-up into High Capacitive Load

DC-DC > Through-Hole > IBA Bus Converters

Alpha-sorted graphics and dimensions augment model listings from both pages.

Unsigned output voltages are isolated and can be used as either + or - polarities.

Additional single-output converters are listed in the DC-DC > Surface Mount and DC-DC > Through-Hole sections.

Brick Size	Input Voltage (VDC)	Factory Set Vout (VDC)	Output Voltage Trim (VDC)	Vout Regulation	Max Current (Amps)	Model
1/8	38 to 55	9.6	7 to 11	Fixed ratio 5:1 line	38	SQT48T38096
1/8	38 to 55	12	8.7 to 13.7	Fixed ratio 4:1 line	20	SQT48T20120
1/8	38 to 60	9.6	7 to 11	Fixed ratio 5:1 line	38	SQT54T38096
1/4	18 to 60	12	11 to 13	4% line/load/temp	6.7	QMS07DH
1/4	36 to 55	9.6	7.2 to 11	Fixed ratio 5:1 line	38	QTS48T38096
1/4	36 to 55	9.6	7.2 to 11	Fixed ratio 5:1 line	46	QTS48T46096
1/4	36 to 75	12	9.6 to 13.2	5% line/load/temp	11	QBC11ZH
1/4	36 to 75	12	N/A	1% line/1% load/3% temp	21	QKS48T21120
1/4	42 to 53	12	10.5 to 13.3	Fixed ratio 4:1 line	25	QTS48T25120
1/2	36 to 75	12	9.6 to 13.2	4% line/load/temp	25	HBC25ZH
1/2	36 to 75	12	9.6 to 13.2	3% line/load/temp	25	HBCS25ZH*
1/2	36 to 75	12	10.8 to 13.2	3% line/load/temp	30	HDS48T30120
1/2	35 to 75	12	10.8 to 13.2	4% line/load/temp	32	HKS48T30120
Full	36 to 75	12	10.8 to 13.2	4% line/load/temp	42	FBC42ZH

* Provides sequencing of up to four point-of-load converters, eliminating the need for an external controller and dramatically simplifying the design of board-level IBA power systems.

SQT is 96% Efficient and Provides 300 W/in³



This optimized bus converter can provide 210 watts at 70°C with 200 LFM airflow.

- Complies with Basic Insulation Requirements of EN60950
- Protections Include Output Overvoltage and Overcurrent, Overtemperature, and Input Undervoltage Lockout
- Onboard Input-Differential LC Filter

HKS Provides Full Regulation and Efficiencies up to 94.5%



The 32-amp HKS48T30120 provides minimal-power-derated operation in elevated temperature environments.

- 2121 VDC Input-to-Output Isolation
- Remote On/Off, Sense, and Output Trim
- Protections Include Output Overvoltage and Overcurrent, Overtemperature, and Input Undervoltage Lockout



QTS48T38, QTS48T46

2.28 x 1.45 x 0.50 inch
57.9 x 36.8 x 12.7 mm

QTS48T25

2.28 x 1.45 x 0.40 inch
57.9 x 36.8 x 10.2 mm



RND

1.87 x 1.00 x 0.34 inch
47.4 x 25.4 x 8.5 mm



QMS

2.28 x 1.45 x 0.5 inch
57.9 x 36.8 x 12.7 mm



SQT48T20

2.30 x 0.9 x 0.39 inch
58.4 x 22.8 x 10 mm

SQT48T38, SQT54T38

2.30 x 0.90 x 0.48 inch
58.4 x 22.8 x 12.1 mm

- Fixed-Ratio Topology
- High Efficiencies and Current Densities

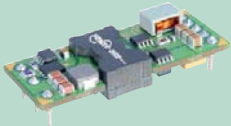

EMS

2.30 x 0.9 x 0.43 inch
58.4 x 22.9 x 10.8 mm



HHS04 & HHS05

2.40 x 2.28 x 0.42 inch
61.0 x 57.9 x 10.7 mm

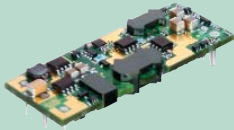

SQ24T & SQ48T

2.30 x 0.90 x 0.28 inch
58.4 x 22.8 x 7.1 mm

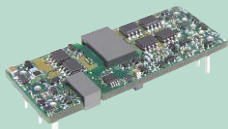

SSE48T

2.30 x 0.90 x 0.41 inch
58.4 x 22.8 x 10.3 mm

DC-DC > Through-Hole > Power-over-Ethernet

Unsigned output voltages are isolated and can be used as either + or - polarities.

Input Voltage (VDC)	Factory Set Vout (VDC)	Output Voltage Trim (VDC)	Max Current (Amps)	Model
36 to 75	52.5	50 to 53	3.8	HHS04Z52
36 to 75	53.7	51.2 to 54.2	4.8	HHS05Z55

DC-DC > Through-Hole > Input Filters

Max Current (Amps)	Voltage (VDC)	Mounting	Meets Conducted	Part Number
5	100	Through-Hole	FCC Class B	FC100V5A
10	100	Through-Hole	FCC Class B	FC100V10A
20	100	Through-Hole	FCC Class B	FC100V20A

DC-DC > Through-Hole > Single-Output > 1/16-Brick

Input Voltage (VDC)	Factory Set Vout (VDC)	Output Voltage Trim (VDC)	Max Current (Amps)	Model
36 to 75	1.2	1.0 to 1.3	25	SSQ48T25012
36 to 75	1.5	1.2 to 1.6	25	SSQ48T25015
36 to 75	1.8	1.4 to 1.9	25	SSQ48T25018
36 to 75	2.5	2 to 2.7	20	SSQ48T20025
36 to 75	3.3	2.6 to 3.6	15	SSQ48T15033
36 to 75	5	4 to 5.5	10	SSQ48T10050

SSQ 1/16th-Brick



The SSQ has an industry-standard, DOSA-compliant package and delivers up to 50 watts of power.

- Isolated Output (Basic Insulation per EN60950)
- Remote Sense, Remote Trim, and Primary Referenced On/Off
- Protections Include Output Overvoltage and Overcurrent, Overtemperature, and Input Undervoltage Lockout
- Monotonic Start-up into Pre-biased Output

Power-over-Ethernet HHS04 & HHS05 Half-Bricks



The HHS04Z52 and HHS05Z55 are designed specifically for Power-over-Ethernet applications and meet the requirements of IEEE802.3af.

- Fully-Regulated Outputs
- 2250 VDC Input-to-Output Isolation
- Remote Sense, Remote Trim, and Primary Referenced On/Off
- Protections Include Output Overvoltage and Overcurrent, Overtemperature, and Input Undervoltage Lockout

DC-DC > Through-Hole > Single-Output > 1/8-Brick

Unsigned output voltages are isolated and can be used as either + or - polarities.

Input Voltage (VDC)	Factory Set Vout (VDC)	Vout Trim (VDC)	Max Current (Amps)	Model
18 to 36Vin				
18 to 36	1	0.9 to 1.1	15	SQ24T15010
18 to 36	1.2	1.1 to 1.3	15	SQ24T15012
18 to 36	1.5	1.2 to 1.6	15	SQ24T15015
18 to 36	1.8	1.5 to 1.9	15	SQ24T15018
18 to 36	2	1.6 to 2.2	15	SQ24T15020
18 to 36	2.5	2 to 2.7	15	SQ24T15025
18 to 36	3.3	2.7 to 3.6	15	SQ24T15033
18 to 36	5	4 to 5.5	10	SQ24T10050
18 to 36	6	4.8 to 6.6	8	SQ24T08060
18 to 36	8	6.4 to 8.8	5.3	SQ24T05080
18 to 36	12	9.6 to 13.2	4	SQ24T04120
19 to 36	15	12 to 16.5	3.3	SQ24T03150
Ultra-Wide Input				
18 to 60	3.3	2.5 to 3.6	15	EMS15DE
18 to 60	5	4.5 to 6	10	EMS10DG
Nominal 48Vin				
36 to 75	1	0.9 to 1.1	15	SQ48T15010
36 to 75	1.2	1.1 to 1.3	15	SQ48T15012
36 to 75	1.2	1.1 to 1.3	30	SQE48T30012
36 to 75	1.5	1.2 to 1.6	15	SQ48T15015
36 to 75	1.5	1.2 to 1.6	30	SQE48T30015
36 to 75	1.8	1.5 to 1.9	15	SQ48T15018
36 to 75	1.8	1.5 to 1.9	30	SQE48T30018
36 to 75	2	1.6 to 2.2	15	SQ48T15020
36 to 75	2.5	2 to 2.7	15	SQ48T15025
36 to 75	2.5	2 to 2.7	30	SQE48T30025
36 to 75	3.3	2.7 to 3.6	15	SQ48T15033
36 to 75	3.3	2.7 to 3.6	20	SQE48T20033
36 to 75	3.3	2.7 to 3.6	30	SQE48T30033
36 to 75	5	4 to 5.5	10	SQ48T10050
36 to 75	5	4 to 5.5	20	SQE48T20050
36 to 75	6	4.8 to 6.6	8	SQ48T08060
36 to 75	8	6.4 to 8.8	5.3	SQ48T05080
36 to 75	12	9.6 to 13.2	4	SQ48T04120
38 to 55	9.6	7 to 11	38	SQT48T38096 *
38 to 55	12	8.7 to 13.7	20	SQT48T20120 *
38 to 60	9.6	7 to 11	38	SQT54T38096 *

* Fixed-ratio input-to-output voltage

High Efficiency SQE Eighth-Brick

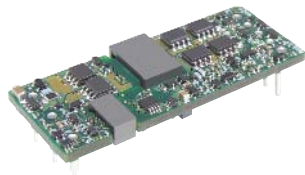

The SQE48T is designed to operate without heat sinks in systems with limited airflow and increased ambient temperatures.

- Start-Up into Pre-Biased Load
- Withstands 100V Input Transient for 100 ms
- No Minimum Load Operation
- Onboard Input-Differential LC Filter

Alpha-sorted graphics and dimensions augment model listings from both pages.

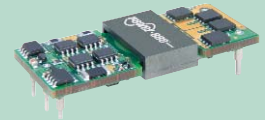

SQT48T20

2.30 x 0.9 x 0.39 inch
58.4 x 22.8 x 10 mm

SQT48T38, SQT54T38

2.30 x 0.90 x 0.48 inch
58.4 x 22.8 x 12.1 mm

- Fixed-Ratio Topology
- High Efficiencies and Current Densities

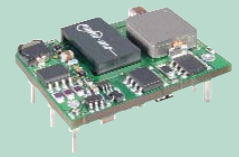

SSQ48T

1.3 x 0.9 x 0.34 inch
33 x 22.9 x 8.51 mm

- Provides Up to 50W
- Isolated Output (Basic insulation per EN60950)
- Industry-Standard DOSA Compliant 1/16th-Brick Package

DC-DC > Through-Hole > Single-Output > 1/4-Brick

Unsigned output voltages are isolated and can be used as either + or - polarities.



Q24T & Q48T

2.30 x 1.45 x 0.28 inch
58.4 x 36.8 x 7.1 mm



QBC

2.28 x 1.45 x 0.43 inch
57.9 x 36.8 x 11 mm



QES

2.30 x 1.45 x 0.34 inch
58.4 x 36.8 x 8.5 mm



QHS

2.30 x 1.45 x 0.50 inch
58.4 x 36.8 x 12.7 mm



QKS

2.30 x 1.45 x 0.50 inch
58.4 x 36.8 x 12.7 mm

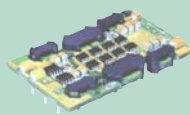

QL48T

2.30 x 1.45 x 0.28 inch
58.4 x 36.8 x 7.1 mm

Input Voltage (VDC)	Factory Set Vout (VDC)	Vout Trim (VDC)	Max Current (Amps)	Model
18 to 36Vin				
18 to 36	1.5	1.2 to 1.6	25	Q24T25015
18 to 36	1.5	1.2 to 1.6	30	Q24T30015
18 to 36	1.8	1.5 to 1.9	25	Q24T25018
18 to 36	1.8	1.5 to 1.9	30	Q24T30018
18 to 36	2	1.6 to 2.2	25	Q24T25020
18 to 36	2	1.6 to 2.2	30	Q24T30020
18 to 36	2.5	2 to 2.7	25	Q24T25025
18 to 36	2.5	2 to 2.7	30	Q24T30025
18 to 36	3.3	3 to 3.6	15	QES050YE-A
18 to 36	3.3	2.7 to 3.6	25	Q24T25033
18 to 36	3.3	2.7 to 3.6	30	Q24T30033
18 to 36	5	4 to 5.5	15	Q24T15050
Ultra-Wide Input				
18 to 60	3.3	2.5 to 3.6	25	QMS25DE
18 to 60	5	4.5 to 6	14	QMS14DG
18 to 60	12	11 to 13	6.75	QMS07DH
Nominal 48Vin				
36 to 75	0.8	0.8	30	QL48T30008
36 to 75	1	0.9 to 1.1	30	QL48T30010
36 to 75	1	0.9 to 1.1	40	QM48T40010
36 to 75	1	0.9 to 1.1	45	QM48T45010
36 to 75	1.2	1.1 to 1.3	30	QL48T30012
36 to 75	1.2	1.1 to 1.3	30	QLS30ZY
36 to 75	1.2	1.1 to 1.3	40	QM48T40012
36 to 75	1.2	1.1 to 1.3	40	QME48T40012
36 to 75	1.2	1.1 to 1.3	45	QM48T45012
36 to 75	1.2	1.1 to 1.3	50	QM48T50012
36 to 75	1.2	1.1 to 1.3	50	QHS50ZY
36 to 75	1.5	1.2 to 1.6	25	Q48T25015
36 to 75	1.5	1.2 to 1.6	30	Q48T30015
36 to 75	1.5	1.4 to 1.6	30	QLS30ZA
36 to 75	1.5	1.2 to 1.6	40	QME48T40015
36 to 75	1.5	1.4 to 1.6	40	QM48T40015
36 to 75	1.5	1.2 to 1.6	45	QM48T45015
36 to 75	1.5	1.2 to 1.6	50	QM48T50015
36 to 75	1.5	1.4 to 1.7	50	QHS50ZA
36 to 75	1.8	1.5 to 1.9	25	Q48T25018
36 to 75	1.8	1.5 to 1.9	30	Q48T30018
36 to 75	1.8	1.7 to 1.9	30	QLS30ZB
36 to 75	1.8	1.4 to 2	40	QME48T40018
36 to 75	1.8	1.6 to 2	40	QHS40ZB
36 to 75	1.8	1.7 to 1.9	40	QM48T40018
36 to 75	1.8	1.5 to 1.9	45	QM48T45018
36 to 75	1.8	1.5 to 1.9	50	QM48T50018

Continued on Next Page

DC-DC > Through-Hole > Single-Output > 1/4-Brick

Unsigned output voltages are isolated and can be used as either + or - polarities.

Input Voltage (VDC)	Factory Set Vout (VDC)	Vout Trim (VDC)	Max Current (Amps)	Model
Nominal 48Vin (Continued)				
36 to 75	2	1.6 to 2.2	25	Q48T25020
36 to 75	2	1.6 to 2.2	30	Q48T30020
36 to 75	2	1.8 to 2.2	40	QM48T40020
36 to 75	2	1.6 to 2.2	45	QM48T45020
36 to 75	2.5	2.3 to 2.7	15	QLS15ZD
36 to 75	2.5	2 to 2.7	25	Q48T25025
36 to 75	2.5	2.3 to 2.7	25	QLS25ZD
36 to 75	2.5	2 to 2.7	30	Q48T30025
36 to 75	2.5	2 to 2.7	40	QME48T40025
36 to 75	2.5	2.3 to 2.7	40	QM48T40025
36 to 75	2.5	2.3 to 2.8	40	QHS40ZD
36 to 75	2.5	2 to 2.7	45	QM48T45025
36 to 75	3.3	3 to 3.6	15	QLS15ZE
36 to 75	3.3	3 to 3.6	15	QES050ZE-A
36 to 75	3.3	3 to 3.6	20	QES066ZE-A
36 to 75	3.3	2.7 to 3.6	25	Q48T25033
36 to 75	3.3	3 to 3.6	25	QLS25ZE
36 to 75	3.3	2.7 to 3.6	30	Q48T30033
36 to 75	3.3	2.7 to 3.6	40	QME48T40033
36 to 75	3.3	2.7 to 3.6	40	QM48T40033
36 to 75	3.3	3 to 3.6	40	QHS40ZE
36 to 75	3.3	2.7 to 3.6	45	QM48T45033
36 to 75	5	4.5 to 5.5	12	QLS12ZG
36 to 75	5	4.5 to 5.5	15	Q48T15050
36 to 75	5	4.5 to 5.5	20	QLS20ZG
36 to 75	5	4 to 5.5	20	Q48T20050
36 to 75	5	4 to 5.5	25	QM48T25050
36 to 75	5	4.5 to 5.5	25	QHS25ZG
36 to 75	5	4 to 5.5	40	QME48T40050
36 to 55	9.6	7.2 to 11	38	QTS48T38096*
36 to 55	9.6	7.2 to 11	46	QTS48T46096*
36 to 75	12	9.6 to 13.2	8	Q48T08120
36 to 75	12	9.6 to 13.2	11	QBC11ZH
36 to 75	12	10.8 to 13.2	12	QHS12ZH
36 to 75	12	9.6 to 13.2	14	Q48T14120
36 to 75	12	9.6 to 13.2	20	QME48T20120
36 to 75	12	N/A	21	QKS48T21120
42 to 53	12	10.5 to 13.3	25	QTS48T25120*

* Fixed-ratio input-to-output voltage

Alpha-sorted graphics and dimensions augment model listings from both pages.



QLS

For QLS15 Model
2.28 x 1.45 x 0.39 inch
57.9 x 36.8 x 9.9 mm

For QLS30 Models
2.28 x 1.45 x 0.43 inch
57.9 x 36.8 x 11 mm



QM48T

2.30 x 1.45 x 0.31 inch
58.4 x 36.8 x 7.8 mm



QME48T

2.30 x 1.45 x 0.48 inch
58.4 x 36.8 x 12.2 mm



QMS

2.28 x 1.45 x 0.5 inch
57.9 x 36.8 x 12.7 mm



QTS48T38, QTS48T46

2.28 x 1.45 x 0.50 inch
57.9 x 36.8 x 12.7 mm

QTS48T25

2.28 x 1.45 x 0.40 inch
57.9 x 36.8 x 10.2 mm

DC-DC > Through-Hole > Single-Output > 1/2-Brick

Unsigned output voltages are isolated and can be used as either + or - polarities.



HAS, HBC, HBCS, & HBS

2.40 x 2.28 x 0.50 inch
61.0 x 57.9 x 12.7 mm



HDS

2.40 x 2.28 x 0.50 inch
61.0 x 57.9 x 12.7 mm



HHS04 & HHS05

2.40 x 2.28 x 0.42 inch
61.0 x 57.9 x 10.7 mm



HHS40 & HHS60

2.40 x 2.28 x 0.50 inch
61.0 x 57.9 x 12.7 mm



HKS

2.40 x 2.28 x 0.50 inch
61.0 x 57.9 x 12.7 mm

Input Voltage (VDC)	Factory Set Vout (VDC)	Vout Trim (VDC)	Max Current (Amps)	Model
18 to 36Vin				
18 to 36	5	4.5 to 5.5	10	HAS050YG-A
18 to 36	5	4.5 to 5.5	10	HBS050YG-A
18 to 36	5	4.5 to 5.5	30	HBS150YG-A
18 to 36	12	10.8 to 13.2	2.5	HBS030YH-A
18 to 36	12	10.8 to 13.2	8.3	HBS100YH-A
18 to 36	12	10.8 to 13.2	12.5	HBS150YH-A
Nominal 48Vin				
36 to 75	1.5	1.4 to 1.7	60	HHS60ZA
36 to 75	1.8	1.6 to 2	60	HHS60ZB
36 to 75	2.5	2.3 to 2.8	60	HHS60ZD
34 to 75	3.3	3 to 3.6	15	HBS050ZE-A
34 to 75	3.3	3 to 3.6	30	HBS100ZE-A
36 to 75	3.3	3 to 3.6	40	HHS40ZE
36 to 75	3.3	3 to 3.6	60	HHS60ZE
36 to 75	5	4.5 to 5.5	6	HAS030ZG-A
34 to 75	5	4.5 to 5.5	30	HBS150ZG-A
36 to 75	12	10.8 to 13.2	2.5	HAS030ZH-A
36 to 75	12	9.6 to 13.2	25	HBC25ZH
36 to 75	12	9.6 to 13.2	25	HBCS25ZH**
36 to 75	12	10.8 to 13.2	30	HDS48T30120
36 to 75	12	10.8 to 13.2	32	HKS48T30120
34 to 75	15	13.5 to 16.5	10	HBS150ZJ-A
34 to 75	24	21.6 to 26.4	6.2	HBS150ZK-A
36 to 75	52.5	50 to 53	3.8	HHS04Z52
36 to 75	53.7	51.2 to 54.2	4.8	HHS05Z55

** Provides sequencing of up to four point-of-load converters, eliminating the need for an external controller and dramatically simplifies the design of board-level IBA power systems.

Power-over-Ethernet Half-Bricks



The HHS04Z52 and HHS05Z55 are designed specifically for Power-Over-Ethernet applications and meet the requirements of IEEE802.3af.

- Fully-Regulated Outputs
- 2250 VDC Input-to-Output Isolation
- Remote Sense, Remote Trim, and Primary Referenced On/Off
- Protections Include Output Overvoltage and Overcurrent, Overtemperature, and Input Undervoltage Lockout

HKS Provides Full Regulation and Efficiencies up to 94.5%



The 32-amp HKS48T30120 utilizes advanced thermal-management techniques to facilitate minimal-power-derated operation in elevated temperature environments.

- 2121 VDC Input-to-Output Isolation
- Remote On/Off, Sense, and Output Trim
- Protections Include Output Overvoltage and Overcurrent, Overtemperature, and Input Undervoltage Lockout

DC-DC > Through-Hole > Single-Output > 3/4-Brick

Unsigned output voltages are isolated and can be used as either + or - polarities.

Input Voltage (VDC)	Factory Set Vout (VDC)	Vout Trim (VDC)	Max Current (Amps)	Model
36 to 72	2.5	2.3 to 2.7	45	TES113ZD-A

DC-DC > Through-Hole > Single-Output > Full-Brick

Input Voltage (VDC)	Factory Set Vout (VDC)	Vout Trim (VDC)	Max Current (Amps)	Model
36 to 75	3.3	3 to 3.6	60	FES200ZE-A
36 to 75	12	10.8 to 13.2	42	FBC42ZH

DC-DC > Through-Hole > Single-Output > Non-Brick

Factory Set Vout (VDC)	Vout Trim (VDC)	Input Voltage (VDC)	Max Current (Amps)	Model
3.3Vout				
3.3	N/A	8.4 to 36	0.9	20IMX4-03-8
3.3	N/A	16.8 to 75	0.9	40IMX4-03-8
3.3	2.5 to 3.5	8 to 36	1.5	20IMX7-03-8
3.3	2.5 to 3.5	16.8 to 75	1.5	40IMX7-03-8
3.3	2.5 to 3.5	40 to 121	1.5	70IMX7-03-8
3.3	3 to 3.6	18 to 36	3	LES010YE
3.3	3 to 3.6	36 to 75	3	LES010ZE
3.3	3 to 3.6	36 to 72	4	IES013ZE-A
3.3	3.2 to 3.4	18 to 36	4	DFA20E24S3.3
3.3	2.6 to 3.5	8.4 to 36	4.5	20IMX15-03-8RG
3.3	2.6 to 3.5	16.8 to 75	4.5	40IMX15-03-8RG
3.3	3 to 3.6	34 to 75	5	OBS017ZE
3.3	3 to 3.6	36 to 72	10	OES033ZE-A
5 to 5.2Vout				
5	N/A	4.5 to 5.5	0.1	DSP1N5S5
5	N/A	4.7 to 5.5	0.3	BRS505
5	N/A	36 to 72	0.5	BWS4805
5	N/A	8.4 to 36	0.7	20IMX4-05-8
5	N/A	16.8 to 75	0.7	40IMX4-05-8
5	N/A	40 to 121	0.7	70IMX4-05-8
5	N/A	9 to 27	1	DFA6U12S5
5	N/A	18 to 36	1	24IMS6-05-9
5	N/A	20 to 60	1	DFA6U48S5
5	N/A	36 to 75	1	48IMS6-05-9
5	N/A	3.5 to 16	1.2	DFC6U5S5

Continued on Next Page

BRS

1.25 x 0.80 x 0.40 inch
31.8 x 20.3 x 10.2 mm

BWS

1.25 X 0.80 X 0.52 inch
31.8 X 20.3 X 13.2 mm

DFA6

2.12 x 1.08 x 0.48 inch
53.9 x 27.4 x 12.2 mm

DFA20

2.02 x 2.02 x 0.45 inch
51.3 x 51.3 x 11.4 mm

DFC6

2.00 x 1.00 x 0.45 inch
50.8 x 25.4 x 11.4 mm

DSP1

0.77 x 0.40 x 0.27 inch
19.6 x 10.2 x 6.9 mm

FBC & FES

4.60 x 2.40 x 0.50 inch
116.8 x 61.0 x 12.7 mm

IES

2.00 x 1.00 x 0.52 inch
50.8 x 25.4 x 13.2 mm

IMS6

1.3 x 0.79 x 0.33 inch
33 x 20 x 8.5 mm

IMX4

1.30 x 0.79 x 0.33 inch
33.0 x 20.1 x 8.5 mm

IMX7

2.00 x 1.00 x 0.42 inch
50.8 x 25.4 x 10.5 mm

IMX15

2.00 x 1.50 x 0.42 inch
50.8 x 38.1 x 10.7 mm

LES

2.00 x 1.00 x 0.40 inch
50.8 x 25.4 x 10.2 mm

OBS & OES

2.00 x 2.00 x 0.42 inch
50.8 x 50.8 x 10.7 mm

TES

3.45 x 2.40 x 0.50 inch
87.6 x 61.0 x 12.7 mm

DC-DC > Through-Hole > Single-Output > Non-Brick

Unsigned output voltages are isolated and can be used as either + or - polarities.

BRS

1.25 x 0.80 x 0.40 inch
31.8 x 20.3 x 10.2 mm

BWS

1.25 X 0.80 X 0.52 inch
31.8 X 20.3 X 13.2 mm

DFA6

2.12 x 1.08 x 0.48 inch
53.9 x 27.4 x 12.2 mm

DFA20

2.02 x 2.02 x 0.45 inch
51.3 x 51.3 x 11.4 mm

DFC6

2.00 x 1.00 x 0.45 inch
50.8 x 25.4 x 11.4 mm

DFC10

2.02 x 1.02 x 0.41 inch
51.3 x 25.9 x 10.7 mm

DFC15

2.02 x 1.62 x 0.55 inch
51.3 x 41.2 x 13.8 mm

DGP12

2.02 x 2.02 x 0.45 inch
51.3 x 51.3 x 11.4 mm

DSP1

0.77 x 0.40 x 0.27 inch
19.6 x 10.2 x 6.9 mm

EWS

2.00 X 1.00 X 0.40 inch
50.8 X 25.4 X 10.2 mm

IAS

2.00 x 1.00 x 0.42 inch
50.8 x 25.4 x 10.7 mm

Factory Set Vout (VDC)	Vout Trim (VDC)	Input Voltage (VDC)	Max Current (Amps)	Model
5 to 5.2Vout (Continued)				
5	4.5 to 5.5	3.5 to 16	2	DGP12U5S5
5	N/A	9 to 18	2	DFC10E12S5
5	N/A	18 to 36	2	DFC10E24S5
5	4.5 to 5.5	34 to 75	2	IAS010ZG
5	N/A	36 to 72	2	DFC10E48S5
5	3.8 to 5.2	50 to 150	2.8	110IMY15-05-05-8
5	4.5 to 5.5	18 to 36	3	LES015YG
5	4.8 to 5.3	20 to 60	3	DFC15U48S5
5	4.5 to 5.5	36 to 75	3	LES015ZG
5	4.8 to 5.3	18 to 36	4	DFA20E24S5
5	4.8 to 5.3	9 to 18	4	DFA20E12S5
5	4.5 to 5.5	16 to 36	4	IES020YG-A
5	4.5 to 5.5	36 to 72	4	IES020ZG-A
5	4.5 to 5.5	40 to 60	4	LES020ZG
5	4.5 to 5.5	34 to 75	5	OBS025ZG
5	4.5 to 5.5	36 to 72	8	OES040ZG-A
5.1	3.8 to 5.4	8.4 to 36	1.2	20IMX7-05-8
5.1	3.8 to 5.4	16.8 to 75	1.2	40IMX7-05-8
5.1	3.8 to 5.4	40 to 121	1.2	70IMX7-05-8
5.1	3.8 to 5.4	60 to 150	1.2	110IMX7-05-8
5.1	4.1 to 5.4	8.4 to 36	2.3	20IMX15-05-8R
5.1	4.1 to 5.4	16.8 to 75	2.5	40IMX15-05-8R
5.1	3.8 to 5.4	50 to 150	2.5	110IMY15-05-8R
5.1	4.1 to 5.4	14 to 36	2.7	24IMS15-05-9R
5.1	4.1 to 5.4	36 to 75	2.7	48IMS15-05-9R
5.1	4 to 5.3	8.4 to 36	3.5	20IMX15-05-8RG
5.1	3.8 to 5.3	16.8 to 75	3.5	40IMX15-05-8RG
5.1	3.8 to 5.3	50 to 150	3.5	110IMY15-05-8RG
5.2	N/A	3.5 to 16	1.2	DFC6U5S5.2
7 to 9Vout				
7	N/A	4.5 to 5.5	0.1	DSP1N5S7
9	N/A	4.7 to 5.5	0.2	BRS509
12Vout				
12	N/A	4.5 to 5.5	0.08	DSP1N5S12
12	N/A	8.4 to 36	0.3	20IMX4-12-8
12	N/A	16.8 to 75	0.3	40IMX4-12-8
12	N/A	3.5 to 16	0.5	DFC6U5S12
12	N/A	4.5 to 9	0.5	EWS512
12	N/A	9 to 27	0.5	DFA6U12S12
12	N/A	20 to 60	0.5	DFA6U48S12
12	N/A	36 to 75	0.5	48IMS6-12-9
12	N/A	9 to 18	0.9	DFC10E12S12
12	N/A	18 to 36	0.9	DFC10E24S12
12	10.8 to 13.2	3.5 to 16	1	DGP12U5S12

Continued on Next Page

DC-DC > Through-Hole > Single-Output > Non-Brick

Alpha-sorted graphics and dimensions augment model listings from both pages.

Unsigned output voltages are isolated and can be used as either + or - polarities.

Factory Set Vout (VDC)	Vout Trim (VDC)	Input Voltage (VDC)	Max Current (Amps)	Model
12	10.8 to 13.2	18 to 36	1.2	LES015YH
12	11.4 to 12.6	20 to 60	1.2	DFC15U48S12
12	9 to 12.6	50 to 150	1.4	110IMY15-12-12-8
12	11.4 to 12.6	9 to 18	1.7	DFA20E12S12
12	11.4 to 12.6	18 to 36	1.7	DFA20E24S12
12	10.8 to 13.2	10 to 20	2.1	OWS1212
12	10.8 to 13.2	34 to 75	2.1	OBS025ZH
14 to 15Vout				
14	N/A	4.5 to 5.5	0.07	DSP1N5S14
15	N/A	4.7 to 5.5	0.07	DSP1N5S15
15	N/A	8.4 to 36	0.3	20IMX4-15-8
15	N/A	16.8 to 75	0.3	40IMX4-15-8
15	N/A	40 to 121	0.3	70IMX4-15-8
15	N/A	3.5 to 16	0.4	DFC6U5S15
15	N/A	9 to 27	0.4	DFA6U12S15
15	N/A	20 to 60	0.4	DFA6U48S15
15	N/A	36 to 75	0.4	48IMS6-15-9
15	N/A	9 to 18	0.7	DFC10E12S15
15	N/A	18 to 36	0.7	DFC10E24S15
15	N/A	36 to 72	0.7	DFC10E48S15
15	13.5 to 16.5	18 to 36	0.8	IAS012YJ
15	13.5 to 16.5	18 to 36	1	LES015YJ
15	14.3 to 15.8	20 to 60	1	DFC15U48S15
15	11.2 to 15.8	50 to 150	1.2	110IMY15-15-15-8
15	14.3 to 15.8	9 to 18	1.4	DFA20E12S15
15	14.3 to 15.8	18 to 36	1.4	DFA20E24S15
17 to 24Vout				
17	N/A	4.5 to 5.5	0.06	DSP1N5S17
24	21.6 to 26.4	10 to 20	5	XWS1224

Additional 24Vout products are available by using dual-output 12V products with outputs connected in series. Please consult the dual-output 12V model listings.

Reduction of Hazardous Substances (RoHS)



In accordance with the full range of compliance options described in the European Union's RoHS Directive, Power-One is offering products in lead-free and lead-solder-exempted versions. This two-tiered strategy provides

customers with compliance choices that will not be offered by all power-system manufacturers. Please refer to the outside back cover of this brochure, or visit www.power-one.com for further details.

IES

2.00 x 1.00 x 0.52 inch
50.8 x 25.4 x 13.2 mm

IMS6

1.3 x 0.79 x 0.33 inch
33 x 20 x 8.5 mm

IMS15

2.00 x 1.60 x 0.41 inch
50.8 x 40.6 x 10.5 mm

IMX4

1.30 x 0.79 x 0.33 inch
33.0 x 20.1 x 8.5 mm

IMX7

2.00 x 1.00 x 0.42 inch
50.8 x 25.4 x 10.5 mm

IMX15/IMY15

2.00 x 1.50 x 0.42 inch
50.8 x 38.1 x 10.7 mm

LES

2.00 x 1.00 x 0.40 inch
50.8 x 25.4 x 10.2 mm

OBS & OES

2.00 x 2.00 x 0.42 inch
50.8 x 50.8 x 10.7 mm

OWS

2.00 x 2.00 x 0.50 inch
50.8 x 50.8 x 12.7 mm

XWS

5.50 x 3.50 x 0.92 inch
139.7 x 88.9 x 23.4 mm

Unsigned output voltages are isolated and can be used as either + or - polarities.



QD48T

2.30 x 1.45 x 0.28 inch
58.4 x 36.8 x 7.2 mm

- Independently-Regulated Outputs
- Minimal Cross-Channel Interference
- Startup into Pre-biased Outputs
- Industry Standard Footprint & Pinout

Input Voltage (VDC)	Factory Set Vout (VDC)	Vout Trim (VDC)	Max Current (Amps)	Power (Watts)	Model
Nominal 48Vin					
36 to 75	+1.2	1.1 to 1.3	15	41	QD48T012015
	+1.5	1.4 to 1.7	15		
36 to 75	+1.2	1.1 to 1.3	15	45	QD48T012018
	+1.8	1.6 to 2	15		
36 to 75	+1.2	1.1 to 1.3	15	56	QD48T012025
	+2.5	2.3 to 2.8	15		
36 to 75	+1.2	1.1 to 1.3	15	68	QD48T012033
	+3.3	3 to 3.6	15		
36 to 75	+1.5	1.4 to 1.7	15	50	QD48T015018
	+1.8	1.6 to 2	15		
36 to 75	+1.5	1.4 to 1.7	15	60	QD48T015025
	+2.5	2.3 to 2.8	15		
36 to 75	+1.5	1.4 to 1.7	15	72	QD48T015033
	+3.3	3 to 3.6	15		
36 to 75	+1.5	1.4 to 1.7	15	73	QD48T015050
	+5	4.5 to 5.5	10		
36 to 75	+1.8	1.6 to 2	15	65	QD48T018025
	+2.5	2.3 to 2.8	15		
36 to 75	+1.8	1.6 to 2	15	77	QD48T018033
	+3.3	3 to 3.6	15		
36 to 75	+1.8	1.6 to 2	15	77	QD48T018050
	+5	4.5 to 5.5	10		
36 to 75	+2	1.8 to 2.2	15	80	QD48T020033
	+3.3	3 to 3.6	15		
36 to 75	+2.5	2.3 to 2.8	15	87	QD48T025033
	+3.3	3 to 3.6	15		
36 to 75	+3.3	3 to 3.6	15	100	QD48T033050
	+5	4.5 to 5.5	10		

Check distributor inventory on-line!

Enter partial or full part number above

www.power-one.com

DC-DC > Through-Hole > Dual-Output > 1/2-Brick

Unsigned output voltages are isolated and can be used as either + or - polarities.

Input Voltage (VDC)	Factory Set Vout (VDC)	Vout Trim (VDC)	Max Current (Amps)	Power (Watts)	Model
18 to 36Vin					
18 to 36	3.3	3 to 3.6	12	40	HBD040YGE-A
	5	4.5 to 5.5	8		
18 to 36	3.3	3 to 3.6	15	60	HBD060YGE-A
	5	4.5 to 5.5	12		
18 to 36	3.3	3 to 3.6	20	85	HHD20YGE
	5	4.5 to 5.5	20		
18 to 60Vin					
18 to 60	3.3	3 to 3.6	15	75	HWD075DGE-A
	5	4.5 to 5.5	15		
Nominal 48Vin					
36 to 72	1.8	1.6 to 2	15	60	HLD15ZEB
	3.3	3 to 3.6	15		
34 to 75	2.5	2.3 to 2.8	15	40	HBD040ZED-A
	3.3	3 to 3.6	12		
36 to 72	2.5	2.3 to 2.8	20	100	HHD25ZED
	3.3	3 to 3.6	25		
34 to 75	3.3	3 to 3.6	12	40	HBD040ZGE-A
	5	4.5 to 5.5	8		
34 to 75	3.3	3 to 3.6	15	60	HBD060ZGE-A
	5	4.5 to 5.5	12		
36 to 72	3.3	3 to 3.6	15	60	HLD15ZGE
	5	4.5 to 5.5	12		

DC-DC > Through-Hole > Dual-Output > 3/4-Brick

Input Voltage (VDC)	Factory Set Vout (VDC)	Vout Trim (VDC)	Max Current (Amps)	Power (Watts)	Model
Nominal 48Vin					
36 to 72	2.5	2.3 to 2.8	25	85	TQD085ZED-A
	3.3	3 to 3.6	20		
36 to 72	3.3	3 to 3.6	25	100	TQD100ZGE-A
	5	4.5 to 5.5	20		

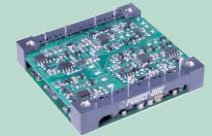

HBD & HHD

2.40 x 2.28 x 0.50 inch
61.0 x 57.9 x 12.7 mm

- Industry Standard 1/2-Brick
- Flexible Load Distribution
- 1500 VDC Input-to-Output Isolation



HLD

2.40 x 2.28 x 0.50 inch
61.0 x 57.9 x 12.7 mm

- Industry Standard Half-Brick
- Planar Magnetics
- Startup into High Capacitive Load
- Independently-Regulated Outputs



HWD

2.40 x 2.28 x 0.50 inch
61.0 x 57.9 x 12.7 mm

- 75 Watts Total Power
- Wide Input Range; 18-60 VDC
- Flexible Load Sharing
- Independently-Regulated Outputs



TQD

2.30 x 1.45 x 0.40 inch
58.4 x 36.8 x 10.2 mm

- Dual Outputs: 2 to 5 VDC
- Up to 100 Watts Total Power
- 18-36 and 36-72 VDC Input Ranges

Unsigned output voltages are isolated and can be used as either + or - polarities.

DFA20

2.02 x 2.02 x 0.45 inch
51.3 x 51.3 x 11.4 mm

DFC10

2.02 x 1.02 x 0.42 inch
51.3 x 25.9 x 10.7 mm

DGP12

2.02 x 2.02 x 0.45 inch
51.3 x 51.3 x 11.4 mm

DSP1

0.77 x 0.40 x 0.27 inch
19.6 x 10.2 x 6.9 mm

IMS6

1.3 x 0.79 x 0.33 inch
33 x 20 x 8.5 mm

IMS15

2.00 x 1.60 x 0.41 inch
50.8 x 40.6 x 10.5 mm

IMS30

2.00 x 2.00 x 0.37 inch
50.8 x 50.8 x 9.4 mm

IMX4

1.30 x 0.79 x 0.33 inch
33.0 x 20.1 x 8.5 mm

IMX7

2.00 x 1.00 x 0.42 inch
50.8 x 25.4 x 10.5 mm

Input Voltage (VDC)	Factory Set Vout (VDC)	Vout Trim (VDC)	Max Current (Amps)	Power (Watts)	Model
3.3V and 5.1V Outputs					
8.4 to 36	+3.3	2.5 to 3.5	1.4	11.3	20IMX15-0503-8R
	+5.1	3.8 to 5.4	1.4		
16.8 to 75	+3.3	2.5 to 3.5	1.5	12.6	40IMX15-0503-8R
	+5.1	3.8 to 5.4	1.5		
50 to 150	+3.3	2.5 to 3.5	1.5	12.6	110IMY15-0503-8R
	+5.1	3.8 to 5.3	1.5		
14 to 36	+3.3	2.5 to 3.5	1.6	13.5	24IMS15-0503-9R
	+5.1	3.8 to 5.4	1.6		
36 to 75	+3.3	2.5 to 3.5	1.6	13.5	48IMS15-0503-9R
	+5.1	3.8 to 5.4	1.6		
32 to 75	+3.3	3 to 3.6	4.2	30	48IMS30-0503-9G
	+5.1	4.6 to 5.6	3.1		
5V Both Outputs					
4.5 to 5.5	+5	N/A	0.07	0.8	DSP1N5D5
	-5	N/A	0.07		
8.4 to 36	+5	N/A	0.3	3.5	20IMX4-0505-8
	-5	N/A	0.3		
16.8 to 75	+5	N/A	0.3	3.5	40IMX4-0505-8
	-5	N/A	0.3		
40 to 121	+5	N/A	0.3	3.5	70IMX4-0505-8
	-5	N/A	0.3		
18 to 36	+5	N/A	0.5	5	24IMS6-0505-9
	-5	N/A	0.5		
8.4 to 36	5	3.8 to 5.2	0.6	6	20IMX7-05-05-8
	5	3.8 to 5.2	0.6		
16.8 to 75	5	3.8 to 5.2	0.7	7	40IMX7-05-05-8
	5	3.8 to 5.2	0.7		
40 to 121	5	3.8 to 5.2	0.7	7	70IMX7-05-05-8
	5	3.8 to 5.2	0.7		
60 to 150	5	3.8 to 5.2	0.7	7	110IMX7-05-05-8
	5	3.8 to 5.2	0.7		
18 to 72	+5	N/A	0.8	8	DFC10U48D5
	-5	N/A	0.8		
9 to 36	+5	N/A	0.8	8.5	DFC10U24D5
	-5	N/A	0.8		

Continued on Next Page

DC-DC > Through-Hole > Dual-Output > Non-Brick

Alpha-sorted graphics and dimensions augment model listings from both pages.

Unsigned output voltages are isolated and can be used as either + or - polarities.

Input Voltage (VDC)	Factory Set Vout (VDC)	Vout Trim (VDC)	Max Current (Amps)	Power (Watts)	Model
3.5 to 16	+5	4.5 to 5.5	1	10	DGP12U5D5
	-5	4.5 to 5.5	1		
8.4 to 36	5	3.8 to 5.3	1.3	13	20IMX15-05-05-8
	5	3.8 to 5.3	1.3		
14 to 36	5	3.8 to 5.3	1.4	14	24IMS15-05-05-9
	5	3.8 to 5.3	1.4		
16.8 to 75	5	3.8 to 5.3	1.4	14	40IMX15-05-05-8
	5	3.8 to 5.3	1.4		
36 to 75	5	3.8 to 5.3	1.4	14	48IMS15-05-05-9
	5	3.8 to 5.3	1.4		
50 to 150	5	3.8 to 5.2	1.4	14	110IMY15-05-05-8
	5	3.8 to 5.2	1.4		
9 to 18	+5	4.8 to 5.3	1.7	17	DFA20E12D5
	-5	4.8 to 5.3	1.7		
18 to 36	+5	4.8 to 5.3	1.7	17	DFA20E24D5
	-5	4.8 to 5.3	1.7		
7V Both Outputs					
4.5 to 5.5	+7	N/A	0.07	1	DSP1N5D7
	-7	N/A	0.07		
12V Both Outputs					
4.5 to 5.5	+12	N/A	0.04	1	DSP1N5D12
	-12	N/A	0.04		
8.4 to 36	+12	N/A	0.2	4	20IMX4-1212-8
	-12	N/A	0.2		
16.8 to 75	+12	N/A	0.2	4	40IMX4-1212-8
	-12	N/A	0.2		
8.4 to 36	12	9 to 12.6	0.2	6	20IMX7-12-12-8
	12	9 to 12.6	0.2		
18 to 36	+12	N/A	0.2	6	24IMS6-1212-9
	-12	N/A	0.2		
16.8 to 75	12	9 to 12.6	0.3	7	40IMX7-12-12-8
	12	9 to 12.6	0.3		
40 to 121	12	9 to 12.6	0.3	7	70IMX7-12-12-8
	12	9 to 12.6	0.3		
60 to 150	12	9 to 12.6	0.3	7	110IMX7-12-12-8
	12	9 to 12.6	0.3		
9 to 36	+12	N/A	0.4	10	DFC10U24D12
	-12	N/A	0.4		

IMX15

2.00 x 1.50 x 0.42 inch
50.8 x 38.1 x 10.7 mm

IMY15

2.00 x 1.50 x 0.42 inch
50.8 x 38.1 x 10.7 mm

Continued on Next Page

Unsigned output voltages are isolated and can be used as either + or - polarities.

BWD
1.25 x 0.80 x 0.52 inch
31.8 x 20.3 x 13.2 mm

DFA20
2.02 x 2.02 x 0.45 inch
51.3 x 51.3 x 11.4 mm

DFC10
1.02 x 2.02 x 0.41 inch
25.9 x 51.3 x 10.7 mm

DFC15
2.02 x 1.62 x 0.55 inch
51.3 x 41.2 x 13.97 mm

DGP12
2.02 x 2.02 x 0.45 inch
51.3 x 51.3 x 11.4 mm

DSP1
0.77 x 0.40 x 0.27 inch
19.6 x 10.2 x 6.9 mm

IAD
2.00 x 1.00 x 0.42 inch
50.8 x 25.4 x 10.7 mm

IMS15
2.00 x 1.50 x 0.42 inch
51.0 x 40.6 x 10.5 mm

IMX4
1.25 x 0.8 x 0.33 inch
32 x 20 x 8.5 mm

IMX7
2.00 x 1.00 x 0.42 inch
50.8 x 25.4 x 10.5 mm

Input Voltage (VDC)	Factory Set Vout (VDC)	Vout Trim (VDC)	Max Current (Amps)	Power (Watts)	Model
12V Both Outputs (Continued)					
18 to 72	+12	N/A	0.4	10	DFC10U48D12
	-12	N/A	0.4		
3.5 to 16	+12	10.8 to 13.2	0.5	12	DGP12U5D12
	-12	10.8 to 13.2	0.5		
8.4 to 36	12	9 to 12.6	0.7	15.6	20IMX15-12-12-8
	12	9 to 12.6	0.7		
14 to 36	12	9 to 12.6	0.7	16.8	24IMS15-12-12-9
	12	9 to 12.6	0.7		
16.8 to 75	12	9 to 12.6	0.7	16.8	40IMX15-12-12-8
	12	9 to 12.6	0.7		
36 to 75	12	9 to 12.6	0.7	16.8	48IMS15-12-12-9
	12	9 to 12.6	0.7		
50 to 150	12	9 to 12.6	0.7	16.8	110IMY15-12-12-8
	12	9 to 12.6	0.7		
9 to 18	+12	11.4 to 12.6	0.8	20.4	DFA20E12D12
	-12	11.4 to 12.6	0.8		
36 to 72	+12	11.4 to 12.6	0.8	20.4	DFA20E48D12
	-12	11.4 to 12.6	0.8		
14V Both Outputs					
4.5 to 5.5	+14	N/A	0.04	1	DSP1N5D14
	-14	N/A	0.04		
15V Both Outputs					
4.5 to 5.5	+15	N/A	0.03	1	DSP1N5D15
	-15	N/A	0.03		
18 to 36	+15	N/A	0.1	3	BWD2415
	-15	N/A	0.1		
36 to 72	+15	N/A	0.1	3	BWD4815
	-15	N/A	0.1		
8.4 to 36	+15	N/A	0.1	4.2	20IMX4-1515-8
	-15	N/A	0.1		
16.8 to 75	+15	N/A	0.1	4.2	40IMX4-1515-8
	-15	N/A	0.1		
8.4 to 36	15	11.2 to 15.8	0.2	6	20IMX7-15-15-8
	15	11.2 to 15.8	0.2		

Continued on Next Page

DC-DC > Through-Hole > Dual-Output > Non-Brick

Alpha-sorted graphics and dimensions augment model listings from both pages.

Unsigned output voltages are isolated and can be used as either + or - polarities.

IMX15

2.00 x 1.50 x 0.42 inch
50.8 x 38.1 x 10.7 mm

IMY15

2.00 x 1.50 x 0.42 inch
50.8 x 38.1 x 10.7 mm

Input Voltage (VDC)	Factory Set Vout (VDC)	Vout Trim (VDC)	Max Current (Amps)	Power (Watts)	Model
15V Both Outputs (Continued)					
16.8 to 75	15	11.2 to 15.8	0.2	7	40IMX7-15-15-8
	15	11.2 to 15.8	0.2		
40 to 121	15	11.2 to 15.8	0.2	7	70IMX7-15-15-8
	15	11.2 to 15.8	0.2		
60 to 150	15	11.2 to 15.8	0.2	7	110IMX7-15-15-8
	15	11.2 to 15.8	0.2		
9 to 36	+15	N/A	0.3	9.6	DFC10U24D15
	-15	N/A	0.3		
18 to 72	+15	N/A	0.3	9.9	DFC10U48D15
	-15	N/A	0.3		
3.5 to 16	+15	13.5 to 16.5	0.4	12	DGP12U5D15
	-15	13.5 to 16.5	0.4		
18 to 36	+15	N/A	0.4	12	IAD012YJJ
	-15	N/A	0.4		
8.4 to 36	15	11.3 to 15.8	0.5	15	20IMX15-15-15-8
	15	11.3 to 15.8	0.5		
20 to 72	+15	9.9 to 15.8	0.5	15	DFC15U48D15
	-15	9.9 to 15.8	0.5		
14 to 36	15	11.3 to 15.8	0.6	16.8	24IMS15-15-15-9
	15	11.3 to 15.8	0.6		
16.8 to 75	15	11.3 to 15.8	0.6	16.8	40IMX15-15-15-8
	15	11.3 to 15.8	0.6		
36 to 75	15	11.3 to 15.8	0.6	16.8	48IMS15-15-15-9
	15	11.3 to 15.8	0.6		
50 to 150	15	11.2 to 15.8	0.6	16.8	110IMY15-15-15-8
	15	11.2 to 15.8	0.6		
9 to 18	+15	14.3 to 15.8	0.7	21	DFA20E12D15
	-15	14.3 to 15.8	0.7		
18 to 36	+15	14.3 to 15.8	0.7	21	DFA20E24D15
	-15	14.3 to 15.8	0.7		
17V Both Outputs					
4.5 to 5.5	+17	N/A	0.03	1	DSP1N5D17
	-17	N/A	0.03		

Continued on Next Page

Check distributor inventory on-line!

Enter partial or full part number above

North America
Europe/Asia

www.power-one.com

IMS15

2.00 x 1.50 x 0.42 inch
51.0 x 40.6 x 10.5 mm

IMX4

1.25 x 0.8 x 0.33 inch
32 x 20 x 8.5 mm

IMX7

2.00 x 1.00 x 0.42 inch
50.8 x 25.4 x 10.5 mm

IMX15, IMY15

2.00 x 1.50 x 0.42 inch
50.8 x 38.1 x 10.7 mm



QNT

2.30 x 1.45 x 0.38 inch
58.4 x 36.8 x 9.7 mm

- Extremely-Wide Output Voltage Adjustment Range
- Programmable Sequencing and Cascading
- Single-Board Design
- Low Profile; < 9.5mm height
- 1500VDC Input-to-Output Isolation

DC-DC > Through-Hole > Dual-Output > Non-Brick

Unsigned output voltages are isolated and can be used as either + or - polarities.

Input Voltage (VDC)	Factory Set Vout (VDC)	Vout Trim (VDC)	Max Current (Amps)	Power (Watts)	Model
24V Both Outputs					
8.4 to 36	+24	N/A	0.08	3.8	20IMX4-2424-8
	-24	N/A	0.08		
16.8 to 75	+24	N/A	0.08	3.8	40IMX4-2424-8
	-24	N/A	0.08		
8.4 to 36	24	18 to 25.2	0.1	6	20IMX7-24-24-8
	24	18 to 25.2	0.1		
16.8 to 75	24	18 to 25.2	0.1	7	40IMX7-24-24-8
	24	18 to 25.2	0.1		
40 to 121	24	18 to 25.2	0.1	7	70IMX7-24-24-8
	24	18 to 25.2	0.1		
60 to 150	24	18 to 25.2	0.1	7	110IMX7-24-24-8
	24	18 to 25.2	0.1		
8.4 to 36	24	18 to 25.2	0.3	15.4	20IMX15-24-24-8
	24	18 to 25.2	0.3		
14 to 36	24	18 to 25.2	0.3	16.8	24IMS15-24-24-9
	24	18 to 25.2	0.3		
16.8 to 75	24	18 to 25.2	0.3	16.8	40IMX15-24-24-8
	24	18 to 25.2	0.3		
36 to 75	24	18 to 25.2	0.3	16.8	48IMS15-24-24-9
	24	18 to 25.2	0.3		
50 to 150	24	18 to 25.2	0.3	16.8	110IMY15-24-24-8
	24	18 to 25.2	0.3		

DC-DC > Through-Hole > Triple-Output > 1/4-Brick

Input Voltage (VDC)	Factory Set Vout (VDC)	Vout Trim (VDC)	Max Current (Amps)	Power (Watts)	Model
36 to 75	+3.3	1.4 to 5	12	80	QNT36ZEDB
	+2.5	1.2 to 3.6	12		
	+1.8	0.9 to 3.6	12		

DC-DC > Through-Hole > Triple-Output > Non-Brick

Unsigned output voltages are isolated and can be used as either + or - polarities.



IMX35

3.00 x 2.50 x 0.41 inch
76.2 x 63.5 x 10.4 mm

- 1500 VDC Isolation
- Extremely Wide Input Voltage Ranges

Input Voltage (VDC)	Factory Set Vout (VDC)	Vout Trim (VDC)	Max Current (Amps)	Power (Watts)	Model
Three 5V Outputs					
9 to 36	5	4.2 to 5.2	1.4	35	20IMX35D05D05-8
	5	4.2 to 5.2	1.4		
	5	4.2 to 5.2	2.7		
18 to 75	5	4.2 to 5.2	1.4	35	40IMX35D05D05-8
	5	4.2 to 5.2	1.4		
	5	4.2 to 5.2	2.8		
40 to 121	5	4.2 to 5.2	1.4	35	70IMX35D05D05-8
	5	4.2 to 5.2	1.4		
	5	4.2 to 5.2	2.8		
60 to 150	5	4.2 to 5.2	1.4	35	110IMX35D05D05-8
	5	4.2 to 5.2	1.4		
	5	4.2 to 5.2	2.8		
Two 5V and One 12V Output					
9 to 36	5	4.2 to 5.2	1.4	35	20IMX35D05D12-8
	5	4.2 to 5.2	1.4		
	12	10.2 to 12.6	1.3		
18 to 75	5	4.2 to 5.2	1.4	35	40IMX35D05D12-8
	5	4.2 to 5.2	1.4		
	12	10.2 to 12.6	1.4		
40 to 121	5	4.2 to 5.2	1.4	35	70IMX35D05D12-8
	5	4.2 to 5.2	1.4		
	12	10.2 to 12.6	1.4		
60 to 150	5	4.2 to 5.2	1.4	35	110IMX35D05D12-8
	5	4.2 to 5.2	1.4		
	12	10.2 to 12.6	1.4		
Two 5V and One 15V Output					
9 to 36	5	4.2 to 5.2	1.4	35	20IMX35D05D15-8
	5	4.2 to 5.2	1.4		
	15	12.8 to 15.8	1.1		
18 to 75	5	4.2 to 5.2	1.4	35	40IMX35D05D15-8
	5	4.2 to 5.2	1.4		
	15	12.8 to 15.8	1.2		
40 to 121	5	4.2 to 5.2	1.4	35	70IMX35D05D15-8
	5	4.2 to 5.2	1.4		
	15	12.8 to 15.8	1.2		
60 to 150	5	4.2 to 5.2	1.4	35	110IMX35D05D15-8
	5	4.2 to 5.2	1.4		
	15	12.8 to 15.8	1.2		

IMX35 outputs can be paralleled and stacked to provide additional voltage/current combinations. Please download the IMX35 data sheet for further details.

DFC25

3.00 x 2.50 x 0.43 inch
76.2 x 63.5 x 11.0 mm

DGP20

2.02 x 2.02 x 0.45 inch
51.3 x 51.3 x 11.4 mm



IMX35

3.00 x 2.50 x 0.41 inch
76.2 x 63.5 x 10.4 mm

- 1500 VDC Isolation
- Extremely Wide Input Voltage Ranges
- Triple-output configurations of this quad-output series utilize two outputs in parallel

DC-DC > Through-Hole > Triple-Output > Non-Brick

Unsigned output voltages are isolated and can be used as either + or - polarities.

Input Voltage (VDC)	Factory Set Vout (VDC)	Vout Trim (VDC)	Max Current (Amps)	Power (Watts)	Model
5V and Two 12V Outputs					
9 to 18	+5	N/A	2.5	20	DGP20E12T5/12
	+12	N/A	0.3		
	-12	N/A	0.3		
18 to 36	+5	N/A	2.5	20	DGP20E24T5/12
	+12	N/A	0.3		
	-12	N/A	0.3		
36 to 72	+5	N/A	2.5	20	DGP20E48T5/12
	+12	N/A	0.3		
	-12	N/A	0.3		
36 to 72	+5	4.5 to 5.5	5	25	DFC25E48T5/12
	+12	N/A	1		
	-12	N/A	1		
9 to 36	5	4.2 to 5.2	2.7	35	20IMX35D05D12-8
	12	10.2 to 12.6	0.7		
	12	10.2 to 12.6	0.7		
18 to 75	5	4.2 to 5.2	2.8	35	40IMX35D05D12-8
	12	10.2 to 12.6	0.7		
	12	10.2 to 12.6	0.7		
40 to 121	5	4.2 to 5.2	2.8	35	70IMX35D05D12-8
	12	10.2 to 12.6	0.7		
	12	10.2 to 12.6	0.7		
60 to 150	5	4.2 to 5.2	2.8	35	110IMX35D05D12-8
	12	10.2 to 12.6	0.7		
	12	10.2 to 12.6	0.7		
5V and Two 15V Outputs					
18 to 36	+5	N/A	2.5	20	DGP20E24T5/15
	+15	N/A	0.2		
	-15	N/A	0.2		
36 to 72	+5	N/A	2.5	20	DGP20E48T5/15
	+15	N/A	0.2		
	-15	N/A	0.2		

Continued on Next Page

Reduction of Hazardous Substances (RoHS)



In accordance with the full range of compliance options described in the European Union's RoHS Directive, Power-One is offering products in lead-free and lead-solder-exempted versions. This two-tiered strategy provides

customers with compliance choices that will not be offered by all power-system manufacturers. Please refer to the outside back cover of this brochure, or visit www.power-one.com for further details.

DC-DC > Through-Hole > Triple-Output > Non-Brick

Alpha-sorted graphics and dimensions augment model listings from both pages.

Unsigned output voltages are isolated and can be used as either + or - polarities.

Input Voltage (VDC)	Factory Set Vout (VDC)	Vout Trim (VDC)	Max Current (Amps)	Power (Watts)	Model
5V and Two 15V Outputs (Continued)					
18 to 36	+5	4.5 to 5.5	5	25	DFC25E24T5/15
	+15	N/A	0.8		
	-15	N/A	0.8		
9 to 36	+5	4.2 to 5.2	2.7	35	20IMX35D05D15-8
	+15	12.8 to 15.8	0.6		
	-15	12.8 to 15.8	0.6		
18 to 75	5	4.2 to 5.2	2.8	35	40IMX35D05D15-8
	15	12.8 to 15.8	0.6		
	15	12.8 to 15.8	0.6		
40 to 121	5	4.2 to 5.2	2.8	35	70IMX35D05D15-8
	15	12.8 to 15.8	0.6		
	15	12.8 to 15.8	0.6		
60 to 150	5	4.2 to 5.2	2.8	35	110IMX35D05D15-8
	15	12.8 to 15.8	0.6		
	15	12.8 to 15.8	0.6		
Three 12V Outputs					
9 to 36	12	10.2 to 12.6	0.7	35	20IMX35D12D12-8
	12	10.2 to 12.6	0.7		
	12	10.2 to 12.6	1.3		
18 to 75	12	10.2 to 12.6	0.7	35	40IMX35D12D12-8
	12	10.2 to 12.6	0.7		
	12	10.2 to 12.6	1.4		
40 to 121	12	10.2 to 12.6	0.7	35	70IMX35D12D12-8
	12	10.2 to 12.6	0.7		
	12	10.2 to 12.6	1.4		
60 to 150	12	10.2 to 12.6	0.7	35	110IMX35D12D12-8
	12	10.2 to 12.6	0.7		
	12	10.2 to 12.6	1.4		
Three 15V Outputs					
9 to 36	15	12.8 to 15.8	0.6	35	20IMX35D15D15-8
	15	12.8 to 15.8	0.6		
	15	12.8 to 15.8	1.1		
18 to 75	15	12.8 to 15.8	0.6	35	40IMX35D15D15-8
	15	12.8 to 15.8	0.6		
	15	12.8 to 15.8	1.2		
40 to 121	15	12.8 to 15.8	0.6	35	70IMX35D15D15-8
	15	12.8 to 15.8	0.6		
	15	12.8 to 15.8	1.2		
60 to 150	15	12.8 to 15.8	0.6	35	110IMX35D15D15-8
	15	12.8 to 15.8	0.6		
	15	12.8 to 15.8	1.2		



IMX35

3.00 x 2.50 x 0.41 inch
76.2 x 63.5 x 10.4 mm

- 1500 VDC Isolation
- Extremely Wide Input Voltage Ranges
- Independent Outputs Can Be Used in Series or Parallel

DC-DC > Through-Hole > Quad-Output > Non-Brick

Unsigned output voltages are isolated and can be used as either + or - polarities.

Input Voltage (VDC)	Factory Set Vout (VDC)	Vout Trim (VDC)	Max Current (Amps)	Power (Watts)	Model
Four 5V Outputs					
9 to 36	5	4.2 to 5.2	1.35	27	20IMX35D05D05-8
	5	4.2 to 5.2	1.35		
	5	4.2 to 5.2	1.35		
	5	4.2 to 5.2	1.35		
18 to 75	5	4.2 to 5.2	1.4	28	40IMX35D05D05-8
	5	4.2 to 5.2	1.4		
	5	4.2 to 5.2	1.4		
	5	4.2 to 5.2	1.4		
40 to 121	5	4.2 to 5.2	1.4	28	70IMX35D05D05-8
	5	4.2 to 5.2	1.4		
	5	4.2 to 5.2	1.4		
	5	4.2 to 5.2	1.4		
60 to 150	5	4.2 to 5.2	1.4	28	110IMX35D05D05-8
	5	4.2 to 5.2	1.4		
	5	4.2 to 5.2	1.4		
	5	4.2 to 5.2	1.4		
Two 5V and Two 12V Outputs					
9 to 36	5	4.2 to 5.2	1.35	29	20IMX35D05D12-8
	12	10.2 to 12.6	0.65		
	12	10.2 to 12.6	0.65		
	5	4.2 to 5.2	1.35		
18 to 75	5	4.2 to 5.2	1.4	30	40IMX35D05D12-8
	12	10.2 to 12.6	0.7		
	12	10.2 to 12.6	0.7		
	5	4.2 to 5.2	1.4		
40 to 121	5	4.2 to 5.2	1.4	30	70IMX35D05D12-8
	12	10.2 to 12.6	0.7		
	12	10.2 to 12.6	0.7		
	5	4.2 to 5.2	1.4		
60 to 150	5	4.2 to 5.2	1.4	30	110IMX35D05D12-8
	12	10.2 to 12.6	0.7		
	12	10.2 to 12.6	0.7		
	5	4.2 to 5.2	1.4		
Two 5V and Two 15V Outputs					
9 to 36	5	4.2 to 5.2	1.35	30	20IMX35D05D15-8
	15	12.8 to 15.8	0.55		
	15	12.8 to 15.8	0.55		
	5	4.2 to 5.2	1.35		
18 to 75	5	4.2 to 5.2	1.4	32	40IMX35D05D15-8
	15	12.8 to 15.8	0.6		
	15	12.8 to 15.8	0.6		
	5	4.2 to 5.2	1.4		
40 to 121	5	4.2 to 5.2	1.4	32	70IMX35D05D15-8
	15	12.8 to 15.8	0.6		
	15	12.8 to 15.8	0.6		
	5	4.2 to 5.2	1.4		
60 to 150	5	4.2 to 5.2	1.4	32	110IMX35D05D15-8
	15	12.8 to 15.8	0.6		
	15	12.8 to 15.8	0.6		
	5	4.2 to 5.2	1.4		

DC-DC > Through-Hole > Quad-Output > Non-Brick

Unsigned output voltages are isolated and can be used as either + or - polarities.

Input Voltage (VDC)	Factory Set Vout (VDC)	Vout Trim (VDC)	Max Current (Amps)	Power (Watts)	Model
Four 12V Outputs					
9 to 36	12	10.2 to 12.6	0.65	31	20IMX35D12D12-8
	12	10.2 to 12.6	0.65		
	12	10.2 to 12.6	0.65		
	12	10.2 to 12.6	0.65		
18 to 75	12	10.2 to 12.6	0.7	34	40IMX35D12D12-8
	12	10.2 to 12.6	0.7		
	12	10.2 to 12.6	0.7		
	12	10.2 to 12.6	0.7		
40 to 121	12	10.2 to 12.6	0.7	34	70IMX35D12D12-8
	12	10.2 to 12.6	0.7		
	12	10.2 to 12.6	0.7		
	12	10.2 to 12.6	0.7		
60 to 150	12	10.2 to 12.6	0.7	34	110IMX35D12D12-8
	12	10.2 to 12.6	0.7		
	12	10.2 to 12.6	0.7		
	12	10.2 to 12.6	0.7		
Four 15V Outputs					
9 to 36	15	12.8 to 15.8	0.55	33	20IMX35D15D15-8
	15	12.8 to 15.8	0.55		
	15	12.8 to 15.8	0.55		
	15	12.8 to 15.8	0.55		
18 to 75	15	12.8 to 15.8	0.6	35	40IMX35D15D15-8
	15	12.8 to 15.8	0.6		
	15	12.8 to 15.8	0.6		
	15	12.8 to 15.8	0.6		
40 to 121	15	12.8 to 15.8	0.6	35	70IMX35D15D15-8
	15	12.8 to 15.8	0.6		
	15	12.8 to 15.8	0.6		
	15	12.8 to 15.8	0.6		
60 to 150	15	12.8 to 15.8	0.6	35	110IMX35D15D15-8
	15	12.8 to 15.8	0.6		
	15	12.8 to 15.8	0.6		
	15	12.8 to 15.8	0.6		

Reduction of Hazardous Substances (RoHS)



In accordance with the full range of compliance options described in the European Union's RoHS Directive, Power-One is offering products in lead-free and lead-solder-exempted versions. This two-tiered strategy provides

customers with compliance choices that will not be offered by all power-system manufacturers. Please refer to the outside back cover of this brochure, or visit www.power-one.com for further details.

DC-DC > Chassis Mount

Unsigned output voltages are isolated and can be used as either + or - polarities.



MDU150

8.00 x 4.20 x 1.50 inch
203.2 x 106.7 x 38.1 mm



MDU200

8.00 x 4.20 x 1.50 inch
203.2 x 106.7 x 38.1 mm

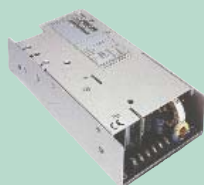

PDC500

9.00 x 5.00 x 2.50 inch
228.6 x 127.0 x 63.5 mm

Input Voltage (VDC)	Factory Set Vout (VDC)	Vout Trim (VDC)	Max Current (Amps)	Power (Watts)	Model
Single-Output Models					
36 to 75	12	11.6 to 16	17	200	MDU200-1012
36 to 75	24	22.8 to 29.2	8.3	200	MDU200-1024
36 to 75	24	21.6 to 26.4	21	500	PDC500-1024
36 to 75	48	45 to 56	4.2	200	MDU200-1048
Triple-Output Models					
36 to 72	+3.3	3.1 to 3.8	35	150	MDU150-3300
	+5	5 to 5.5	20		
	+12	N/A	2		
Quad-Output Models					
36 to 75	+2.5	2.25 to 3.0	30	150	MDU150-4230
	+3.3	3.15 to 3.8	15		
	12	10.8 to 13.2	3		
	5	5 to 5.5	2		
36 to 75	+3.3	3.15 to 3.8	30	150	MDU150-4350
	+5	5 to 5.5	15		
	12	10.8 to 13.2	3		
	12	10.8 to 13.2	3		
36 to 75	+5	5 to 5.5	30	150	MDU150-4530
	+3.3	3.15 to 3.8	15		
	12	10.8 to 13.2	3		
	12	10.8 to 13.2	3		
36 to 75	+5	5 to 5.5	30	150	MDU150-4000
	+12	10.8 to 13.2	8		
	12	10.8 to 13.2	3		
	5	5 to 5.5	2		

Check distributor inventory on-line!

Enter partial or full part number above



North America

Europe/Asia

www.power-one.com

Railway and Rugged Product Overview

AC-DC and DC-DC System-Level Products for Railway and Rugged Applications

Extremely robust electrical and mechanical designs have enabled Power-One's broad range of railway and rugged products to establish a proven track record of industry leading reliability, in a diverse array of transportation, communications, and industrial infrastructure applications.

Isolated Cassette Style AC-DC and DC-DC



A broad range of extremely flexible cassettes are available, providing from one to four outputs.

- Features include high efficiencies, low noise outputs, power factor correction, excellent line/load response, wide-range inputs, and extensive interface capabilities
- LED status indicators facilitate visual monitoring
- Chassis, rack, and DIN-rail mounting



Cost-effective custom rack power solutions can be easily configured with readily available accessories, such as cassette front panels and 19" rack frames.



DIN-Rail Mount Converters and Battery Chargers

Single and dual output converters and battery chargers, operating from ac and dc inputs, are available in power ratings from 15 to 500 watts. The high-reliability products are ideal power sources for demanding applications such as building control systems, factory automation, industrial controls, instrumentation, electromagnetic drives, fans and other DC loads.



DC-DC Positive Switching Regulators



These non-isolated buck-converter topology converters provide single outputs, from 5.1 to 48V, utilizing inputs up to 144VDC. Additional features of these extremely high reliability products include: no power derating over the entire operating temperature range, no minimum load operation, wide output adjustment ranges, and -40 to 71°C extended-temperature-range options.

In addition to the railway and rugged products described on the next ten pages, Power-One's industrial-application solutions include:

- **Extended temperature range board-mount dc-dc converters**
- **Open-frame ac-dc linear power supplies**
- **CompactPCI in ac-dc and dc-dc configurations**

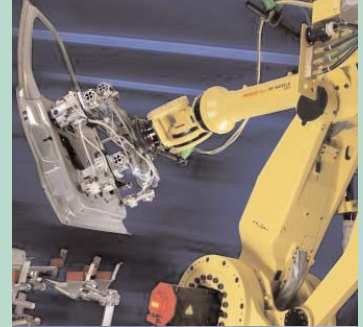



PSA, PSR

2.76 x 2.00 x 1.00 inch
70.1 x 50.8 x 25.4 mm



PSB

4.17 x 2.72 x 1.27 inch
106 x 69 x 32.2 mm



PSC

5.94 x 3.46 x 1.27 inch
151 x 88 x 32.2 mm

- Options:
- 9 Ambient temperature range
-40 to 71°C
 - A Test sockets
 - B Cooling plate large
 - B1 Cooling plate small
 - C Thyristor-Crowbar
 - D "Save Data" undervoltage
monitor
 - E Inrush current limitation
 - i Inhibit
 - L Input filter
 - P Potentiometer for Vout
 - R External output voltage
control
 - Y Small soldering pins
(0.5 x 1 mm)



DC-DC > Positive Switching Regulators

Output Voltage Adjusts 0-110% in PSS Models with "R" Suffix;
Output Voltage Adjusts 0-108% in All Other Models with "R" Suffix.

Output (VDC)	Output (Amps)	Input (VDC)	Power (Watts)	Efficiency	Model	Options
DC-DC Chassis Mount PSRs:						
+3.3	12	6 to 40	39.6	77	PSC3E12-2	iR-Package
+5	2	8 to 80	10	74	PSR52-7	Y
+5	3	8 to 80	15	79	PSR53-7	-9, i, P, R, Y
+5	4	7 to 40	20	83	PSR54-7	-9, i, P, R, Y
+5	5	7 to 35	25	83	PSA55-7	-9, i, P, R, Y
+5.1	2	8 to 40	10.2	75	PSA5A2-2	iRY-Package
+5.1	5	15 to 144	25.5	80	PSB5A4-7iR	-9, L, P, C
+5.1	5	7 to 35	25.5	83	PSA5A5-2	iRY-Package
+5.1	6	8 to 80	30.6	81	PSB5A6-7iR	-9, L, P, C
+5.1	7	7 to 40	35.7	84	PSB5A7-7iR	-9, L, P, C
+5.1	8	7 to 40	40.8	81	PSB5A8-2	iR-Package
+5.1	10	8 to 80	51	79	PSC5A10-7iR	-9, L, P, C, D
+5.1	11	8 to 40	56.1	79	PSC5A11-2	iR-Package
+5.1	12	7 to 40	61.2	83	PSC5A12-7iR	-9, L, P, C, D
+12	1.5	18 to 144	18	87	PSA121.5-7iR	-9, P, Y
+12	2.5	15 to 80	30	87	PSR122.5-7	-9, i, P, R, Y
+12	3	15 to 40	36	89	PSA123-2	iRY-Package
+12	4	18 to 144	48	89	PSB123-7iR	-9, L, P, C
+12	5	15 to 80	60	90	PSB125-7iR	-9, L, P, C
+12	6	15 to 40	72	90	PSB126-2	iR-Package
+12	6	18 to 144	72	89	PSC126-7iR	-9, L, P, C, D
+12	8	15 to 80	96	90	PSC128-7iR	-9, L, P, C, D
+12	9	15 to 40	108	90	PSC129-2	iR-Package
+15	1.5	22 to 144	22.5	89	PSA151.5-7iR	-9, P, Y
+15	2.5	19 to 80	37.5	89	PSR152.5-7	-9, i, P, R, Y
+15	3	19 to 40	45	90	PSA153-2	iRY-Package
+15	4	22 to 144	60	90	PSB153-7iR	-9, L, P, C
+15	5	19 to 80	75	92	PSB155-7iR	-9, L, P, C
+15	6	19 to 40	90	92	PSB156-2	iR-Package
+15	6	22 to 144	90	90	PSC156-7iR	-9, L, P, C, D
+15	8	19 to 80	120	91	PSC158-7iR	-9, L, P, C, D
+15	9	19 to 40	135	91	PSC159-2	iR-Package
+24	1.5	31 to 144	36	93	PSA241.5-7iR	-9, P, Y
+24	2	29 to 80	48	92	PSR242-7	-9, i, P, R, Y
+24	2.5	29 to 60	60	93	PSA242.5-2	iRY-Package
+24	4	31 to 144	96	94	PSB243-7iR	-9, L, P, C
+24	5	29 to 80	120	95	PSB245-7iR	-9, L, P, C
+24	6	29 to 60	144	95	PSB246-2	iR-Package
+24	6	31 to 144	144	94	PSC246-7iR	-9, L, P, C, D
+24	8	29 to 80	192	94	PSC248-7iR	-9, L, P, C, D
+24	9	29 to 60	216	94	PSC249-2	iR-Package
+36	1.2	44 to 144	43.2	95	PSA361-7iR	-9, P, Y
+36	2	42 to 80	72	94	PSR362-7	-9, i, P, R, Y
+36	4	44 to 144	144	95	PSB363-7iR	-9, L, P, C
+36	5	42 to 80	180	96	PSB365-7iR	-9, L, P, C
+36	6	44 to 144	216	95	PSC366-7iR	-9, L, P, C, D
+36	8	42 to 80	288	96	PSC368-7iR	-9, L, P, C, D

DC-DC > Positive Switching Regulators

Output Voltage Adjusts 0-110% in PSS Models with "R" Suffix;
Output Voltage Adjusts 0-108% in All Other Models with "R" Suffix.

Output (VDC)	Output (Amps)	Input (VDC)	Power (Watts)	Efficiency	Model	Options
DC-DC Chassis Mount PSRs: (Continued)						
+48	1	58 to 144	48	95	PSA481-7iR	-9, P, Y
+48	4	58 to 144	192	96	PSB483-7iR	-9, L, P, C
DC-DC Cassette Style PSRs:						
+5.1	10	8 to 80	51	79	PSL5A10-7R	-9, L, i, P, C, D, A
+5.1	11	8 to 40	56.1	79	PSL5A11-2R	
+5.1	12	7 to 40	61.2	83	PSL5A12-7R	-9, L, i, P, C, D, A
+5.1	12	8 to 80	61.2	79	PSS5A12-7	-9, E, P, C, B, B1
+5.1	14	8 to 40	71.4	83	PSS5A14-2	B, B1
+5.1	16	8 to 80	81.6	79	PSK5A16-7	-9, E, P, C, B, B1
+5.1	18	8 to 40	91.8	82	PSK5A18-2	B, B1
+5.1	20	8 to 80	102	79	PSK5A20-7	-9, E, P, C, B, B1
+5.1	25	8 to 40	127.5	82	PSK5A25-7	-9, E, P, C, B, B1
+12	6	18 to 144	72	89	PSL126-7R	-9, L, i, P, C, D, A
+12	8	15 to 80	96	90	PSL128-7R	-9, L, i, P, C, D, A
+12	9	15 to 40	108	90	PSL129-2R	
+12	9	18 to 144	108	91	PSS129-7	-9, E, P, C, B, B1
+12	12	15 to 80	144	91	PSS1212-7	-9, E, P, C, B, B1
+12	12	18 to 144	144	91	PSK1212-7	-9, E, P, C, B, B1
+12	14	16 to 40	168	90	PSS1214-2	B, B1
+12	16	15 to 80	192	90	PSK1216-7	-9, E, P, C, B, B1
+12	18	16 to 40	216	90	PSK1218-2	B, B1
+12	20	15 to 80	240	90	PSK1220-7	-9, E, P, C, B, B1
+15	6	22 to 144	90	90	PSL156-7R	-9, L, i, P, C, D, A
+15	8	19 to 80	120	91	PSL158-7R	-9, L, i, P, C, D, A
+15	9	19 to 40	135	91	PSL159-2R	
+24	6	31 to 144	144	94	PSL246-7R	-9, L, i, P, C, D, A
+24	8	29 to 80	192	94	PSL248-7R	-9, L, i, P, C, D, A
+24	9	29 to 60	216	94	PSL249-2R	
+24	9	31 to 144	216	94	PSS249-7	-9, E, P, C, B, B1
+24	12	29 to 80	288	94	PSS2412-7	-9, E, P, C, B, B1
+24	12	31 to 144	288	94	PSK2412-7	-9, E, P, C, B, B1
+24	14	29 to 60	336	94	PSS2414-2	B, B1
+24	16	29 to 80	384	94	PSK2416-7	-9, E, P, C, B, B1
+24	18	29 to 60	432	94	PSK2418-2	B, B1
+24	20	29 to 80	480	94	PSK2420-7	-9, E, P, C, B, B1
+36	6	44 to 144	216	96	PSL366-7R	-9, L, i, P, C, D, A
+36	8	42 to 80	288	96	PSL368-7R	-9, L, i, P, C, D, A
+36	9	44 to 144	324	96	PSS369-7	-9, E, P, C, B, B1
+36	12	42 to 80	432	96	PSS3612-7	-9, E, P, C, B, B1
+36	12	44 to 144	432	96	PSK3612-7	-9, E, P, C, B, B1
+36	16	42 to 80	576	95	PSK3616-7	-9, E, P, C, B, B1
+36	20	42 to 80	720	95	PSK3620-7	-9, E, P, C, B, B1
+48	6	58 to 144	288	97	PSL486-7R	-9, L, i, P, C, D, A
+48	9	58 to 144	432	97	PSS489-7	-9, E, P, C, B, B1
+48	12	58 to 144	576	97	PSK4812-7	-9, E, P, C, B, B1

Alpha-sorted graphics and dimensions augment model listings from both pages.



PSK

6.77 x 4.37 x 3.15 inch
171.9 x 111 (3U) x 80 (16TE) mm



PSL

6.83 x 4.21 x 1.44 inch
173.7 x 107 x 36.5 mm



PSS

6.77 x 4.37 x 2.36 inch
171.9 x 111 (3U) x 60 (12TE) mm

Options:

- 9 Ambient temperature range
-40 to 71°C
- A Test sockets
- B Cooling plate large
- B1 Cooling plate small
- C Thyristor-Crowbar
- D "Save Data" undervoltage monitor
- E Inrush current limitation
- i Inhibit
- L Input filter
- P Potentiometer for Vout
- R External output voltage control



Unsigned output voltages are isolated and can be used as either + or - polarities.

K Series

150 Watt DC-DC converters

Output Adjustment Ranges

The following adjustment ranges apply to all models.

Vout	Low	High
5.1	0	5.6
12	0	13.2
15	0	16.5
24	0	26.4



6.6 x 4.4(3U) x 3.2(16 TE) inch
168 x 111 x 80 mm

Please see the AC-DC K-Series data sheets for AC input LK models.



Output 1, 2 (VDC)	Output 1, 2 (Amps)	Model	Input Voltage (VDC)	Options
5.1	20	AK1001-7R	8 to 35	-9, D, V, P, T, B1, B2
12	10	AK1301-7R	8 to 35	-9, D, P, T, B1, B2
15	8	AK1501-7R	8 to 35	-9, D, P, T, B1, B2
24	5	AK1601-7R	8 to 35	-9, D, P, T, B1, B2
12, 12	5, 5	AK2320-7R	8 to 35	-9, D, P, T, B1, B2
15, 15	4, 4	AK2540-7R	8 to 35	-9, D, P, T, B1, B2
24, 24	2.5, 2.5	AK2660-7R	8 to 35	-9, D, P, T, B1, B2

Output 1, 2 (VDC)	Output 1, 2 (Amps)	Model Input 14 to 70 VDC	Model Input 20 to 100 VDC	Options
5.1	25	BK1001-7R	FK1001-7R	-9, D, V, P, T, B1, B2
12	12	BK1301-7R	FK1301-7R	-9, D, P, T, B1, B2
15	10	BK1501-7R	FK1501-7R	-9, D, P, T, B1, B2
24	6	BK1601-7R	FK1601-7R	-9, D, P, T, B1, B2
12, 12	6, 6	BK2320-7R	FK2320-7R	-9, D, P, T, B1, B2
15, 15	5, 5	BK2540-7R	FK2540-7R	-9, D, P, T, B1, B2
24, 24	3, 3	BK2660-7R	FK2660-7R	-9, D, P, T, B1, B2

Output 1, 2 (VDC)	Output 1, 2 (Amps)	Model Input 28 to 140 VDC	Model Input 44 to 220 VDC	Model Input 67 to 385 VDC	Options
5.1	25	CK1001-7R	DK1001-7R		-9, E, D, V, P, T, B1, B2
12	12	CK1301-7R	DK1301-7R	EK1301-7R	-9, E, D, P, T, B1, B2
15	10	CK1501-7R	DK1501-7R	EK1501-7R	-9, E, D, P, T, B1, B2
24	6	CK1601-7R	DK1601-7R	EK1601-7R	-9, E, D, P, T, B1, B2
12, 12	6, 6	CK2320-7R	DK2320-7R	EK2320-7R	-9, E, D, P, T, B1, B2
15, 15	5, 5	CK2540-7R	DK2540-7R	EK2540-7R	-9, E, D, P, T, B1, B2
24, 24	3, 3	CK2660-7R	DK2660-7R	EK2660-7R	-9, E, D, P, T, B1, B2

Additional K, M, and S DC-DC Series Features and Options:

- Safety: Class I equipment according to IEC/EN 60950, UL 1950
- Extremely wide input voltage range
- Input over- and undervoltage lockout
- Output voltage control (R) and inhibit
- Surge and transient suppression circuitry
- Fully isolated outputs
- Outputs open- and short-circuit proof
- Ambient temperature range
-7: -25 to 71°C
- No derating over temperature (exception: AK have reduced output power, approx. 85%)

Options:

- 9 Ambient temperature range -40 to 71°C
- E Inrush current limitation (CK, CM, CS, DK, DS, EK, ES, FS, and LM models only)
- D Save data signal
- P Potentiometer for Vout
- T Current sharing (K and S Series only)
- B1,B2 Cooling plate (K and S Series only)
- A Output voltage test sockets (M Series only)
- V AC fail signal according to VME Standard (only models with V_O = 5.1)

DC-DC > Cassette > M Series

Unsigned output voltages are isolated and can be used as either + or - polarities.

Output 1, 2, 3 (VDC)	Output 1, 2, 3 (Amps)	Model Input 8 to 35 VDC	Model Input 14 to 70 VDC	Model Input 20 to 100 VDC	Options
5.1	8	AM1001-7R	BM1001-7R	FM1001-7R	-9, A, P, D
12	4	AM1301-7R	BM1301-7R	FM1301-7R	-9, A, P, D
15	3.4	AM1501-7R	BM1501-7R	FM1501-7R	-9, A, P, D
24	2	AM1601-7R	BM1601-7R	FM1601-7R	-9, A, P, D
48	1	AM1901-7R	BM1901-7R	FM1901-7R	-9, A, P, D
12, 12	2, 2	AM2320-7	BM2320-7	FM2320-7	-9, A, P, D
15, 15	1.7, 1.7	AM2540-7	BM2540-7	FM2540-7	-9, A, P, D
5.1, 12, 12	5, 0.7, 0.7	AM3020-7	BM3020-7	FM3020-7	-9, A, P, D
5.1, 15, 15	5, 0.6, 0.6	AM3040-7	BM3040-7	FM3040-7	-9, A, P, D

Output 1, 2, 3 (VDC)	Output 1, 2, 3 (Amps)	Model Input 28 to 140 VDC	Model Input 44 to 220 VDC	Model Input 88 to 372 VDC	Options
5.1	8	CM1001-7R	DM1001-7R	LM1001-7R	-9, A, E, P, D
12	4	CM1301-7R	DM1301-7R	LM1301-7R	-9, A, E, P, D
15	3.4	CM1501-7R	DM1501-7R	LM1501-7R	-9, A, E, P, D
24	2	CM1601-7R	DM1601-7R	LM1601-7R	-9, A, E, P, D
48	1	CM1901-7R	DM1901-7R	LM1901-7R	-9, A, E, P, D
12, 12	2, 2	CM2320-7	DM2320-7	LM2320-7	-9, A, E, P, D
15, 15	1.7, 1.7	CM2540-7	DM2540-7	LM2540-7	-9, A, E, P, D
5.1, 12, 12	5, 0.7, 0.7	CM3020-7	DM3020-7	LM3020-7	-9, A, E, P, D
5.1, 15, 15	5, 0.6, 0.6	CM3040-7	DM3040-7	LM3040-7	-9, A, E, P, D

DC-DC > Cassette > S Series

Output 1, 2 (VDC)	Output 1, 2 (Amps)	Model Input 8 to 35 VDC	Model Input 14 to 70 VDC	Model Input 20 to 100 VDC	Options
5.1	16	AS1001-7R	BS1001-7R	FS1001-7R	-9, D, V, P, T, B1, B2
12	8	AS1301-7R	BS1301-7R	FS1301-7R	-9, D, P, T, B1, B2
15	6.5	AS1501-7R	BS1501-7R	FS1501-7R	-9, D, P, T, B1, B2
24	4.2	AS1601-7R	BS1601-7R	FS1601-7R	-9, D, P, T, B1, B2
12, 12	4, 4	AS2320-7R	BS2320-7R	FS2320-7R	-9, D, P, T, B1, B2
15, 15	3.2, 3.2	AS2540-7R	BS2540-7R	FS2540-7R	-9, D, P, T, B1, B2
24, 24	2, 2	AS2660-7R	BS2660-7R	FS2660-7R	-9, D, P, T, B1, B2

Output 1, 2 (VDC)	Output 1, 2 (Amps)	Model Input 28 to 140 VDC	Model Input 44 to 220 VDC	Model Input 67 to 385 VDC	Options
5.1	16	CS1001-7R	DS1001-7R	ES1001-7R	-9, E, D, V, P, T, B1, B2
12	8	CS1301-7R	DS1301-7R	ES1301-7R	-9, E, D, P, T, B1, B2
15	6.5	CS1501-7R	DS1501-7R	ES1501-7R	-9, E, D, P, T, B1, B2
24	4.2	CS1601-7R	DS1601-7R	ES1601-7R	-9, E, D, P, T, B1, B2
12, 12	4, 4	CS2320-7R	DS2320-7R	ES2320-7R	-9, E, D, P, T, B1, B2
15, 15	3.2, 3.2	CS2540-7R	DS2540-7R	ES2540-7R	-9, E, D, P, T, B1, B2
24, 24	2, 2	CS2660-7R	DS2660-7R	ES2660-7R	-9, E, D, P, T, B1, B2

M Series

50 Watt DC-DC converters

Output Adjustment Ranges

The following adjustment ranges apply to all single-output models.

Vout	Low	High
5.1	0	5.6
12	0	13.2
15	0	16.5
24	0	26.4
48	0	52.8



6.6 x 4.4(3U) x 1.54(8 TE) inch
168 x 111 x 39 mm



(See opposing page for additional M & S DC-DC Series features and options.)

S Series

100 Watt DC-DC converters

Output Adjustment Ranges

The following adjustment ranges apply to all models.

Vout	Low	High
5.1	0	5.6
12	0	13.2
15	0	16.5
24	0	26.4
48	0	52.8



6.6 x 4.4(3U) x 2.4(12 TE) inch
168 x 111 x 60 mm

Please see the AC-DC S-Series data sheets for AC input LS models.



Unsigned output voltages are isolated and can be used as either + or - polarities.

P Series

85 to 194 Watt DC-DC converters

Output Adjustment Ranges

The following adjustment ranges apply to single-output models and V1 of multi-output models.

Vout	Low	High
3.3	2.0	3.6
5.1	4.0	5.6
12	6.5	13.2
15	9.0	16.5
24	14.0	26.4



6.5 x 4.4(3U) x 0.8(4 TE) inch
164 x 111 x 20 mm

- Safety: Class I equipment according to IEC/EN 60950, UL 1950
- Flexible load distribution
- Excellent surge and transient protection
- Very high efficiency up to 92%
- Ambient temperature range -7: -25 to 71°C
- Parallelability
- Extremely low inrush current, hot plug-in
- Inhibit on primary side
- Extremely slim case (4TE wide) fully enclosed

Options:

- 9 Ambient temperature range -40 to 71°C
- D Out OK output
- T Current sharing
- R Output voltage adjust
- B1, B3 Cooling plate



Vout 1, 4 (VDC)	Vout 2, 3 (VDC)	Max. Watts	Nom. Watts	Model Input 16 to 36 VDC	Model Input 33.6 to 75 VDC
3.3		132	100	BP1101-7R	CP1101-7R
5.1		183	122	BP1001-7R	CP1001-7R
3.3	5.1	157	111	BP2101-7R	CP2101-7R
5.1	5.1	182	122	BP2001-7R	CP2001-7R
12	12	192	120	BP2320-7R	CP2320-7R
15	15	194	120	BP2540-7R	CP2540-7R
24	24	192	120	BP2660-7R	CP2660-7R
5.1	12, 12	187	121	BP3020-7R	CP3020-7R
5.1	15, 15	187	121	BP3040-7R	CP3040-7R
5.1	24, 24	187	121	BP3060-7R	CP3060-7R
5.1, 3.3	12, 12	146	90	BP4720-7R	CP4720-7R
12, 12	12, 12	192	120	BP4320-7R	CP4320-7R
15, 15	15, 15	192	120	BP4540-7R	CP4540-7R
24, 24	24, 24	192	120	BP4660-7R	CP4660-7R

Vout 1, 4 (VDC)	Vout 2, 3 (VDC)	Max. Watts	Nom. Watts	Model Input 40 to 101 VDC	Model Input 66 to 150 VDC
3.3		132	100	DP1101-7R	EP1101-7R
5.1		183	122	DP1001-7R	EP1001-7R
3.3	5.1	157	111	DP2101-7R	EP2101-7R
5.1	5.1	182	122	DP2001-7R	EP2001-7R
12	12	192	120	DP2320-7R	EP2320-7R
15	15	194	120	DP2540-7R	EP2540-7R
24	24	192	120	DP2660-7R	EP2660-7R
5.1	12, 12	187	121	DP3020-7R	EP3020-7R
5.1	15, 15	187	121	DP3040-7R	EP3040-7R
5.1	24, 24	187	121	DP3060-7R	EP3060-7R
5.1, 3.3	12, 12	146	90	DP4720-7R	EP4720-7R
12, 12	12, 12	192	120	DP4320-7R	EP4320-7R
15, 15	15, 15	192	120	DP4540-7R	EP4540-7R
24, 24	24, 24	192	120	DP4660-7R	EP4660-7R

Vout 1, 4 (VDC)	Vout 2, 3 (VDC)	Max. Watts	Nom. Watts	Model Input 21.6 to 50.4 VDC
3.3		132	100	GP1101-7R
5.1		183	122	GP1001-7R
3.3	5.1	157	111	GP2101-7R
5.1	5.1	182	122	GP2001-7R
12	12	192	120	GP2320-7R
15	15	194	120	GP2540-7R
24	24	192	120	GP2660-7R
5.1	12, 12	187	121	GP3020-7R
5.1	15, 15	187	121	GP3040-7R
5.1	24, 24	187	121	GP3060-7R
5.1, 3.3	12, 12	146	90	GP4720-7R
12, 12	12, 12	192	120	GP4320-7R
15, 15	15, 15	192	120	GP4540-7R
24, 24	24, 24	192	120	GP4660-7R

DC-DC > Cassette > Q Series

Unsigned output voltages are isolated and can be used as either + or - polarities.

Output 1, 2 (VDC)	Output 1, 2 (Amps)	(Amps) $T_A = 50^\circ\text{C}$	Model Input 14.4 to 36 VDC	Model Input 21.6 to 54 VDC	Model Input 35 to 75 VDC	Options
3.3	20	25	BQ1101-7	GQ1101-7	CQ1101-7	-9, B1
5.1	16	20	BQ1001-7R	GQ1001-7R	CQ1001-7R	-9, B1, P
5.1, 5.1	7.5, 7.5	9.5, 9.5	BQ2001-7R	GQ2001-7R	CQ2001-7R	-9, B1
12, 12	4, 4	5, 5	BQ2320-7R	GQ2320-7R	CQ2320-7R	-9, B1, P
15, 15	3.3, 3.3	4, 4	BQ2540-7R	GQ2540-7R	CQ2540-7R	-9, B1, P
24, 24	2.2, 2.2	2.75, 2.75	BQ2660-7R	GQ2660-7R	CQ2660-7R	-9, B1, P

Output 1, 2 (VDC)	Output 1, 2 (Amps)	(Amps) $T_A = 50^\circ\text{C}$	Model Input 43 to 108 VDC	Model Input 65 to 150 VDC	Options
3.3	20	25	DQ1101-7	EQ1101-7	-9, B1
5.1	16	20	DQ1001-7R	EQ1001-7R	-9, B1, P
5.1, 5.1	7.5, 7.5	9.5, 9.5	DQ2001-7R	EQ2001-7R	-9, B1
12, 12	4, 4	5, 5	DQ2320-7R	EQ2320-7R	-9, B1, P
15, 15	3.3, 3.3	4, 4	DQ2540-7R	EQ2540-7R	-9, B1, P
24, 24	2.2, 2.2	2.75, 2.75	DQ2660-7R	EQ2660-7R	-9, B1, P

- Safety: Class I equipment according to IEC/EN 60950, UL 1950, EN 41003
- Extremely slim case (4TE wide), fully enclosed
- Outputs, units parallel or series configurable
- Flexible load distribution
- Very high efficiency up to 90%
- Ambient temperature ranges:
-7: -25 to 71°C
-2: -10 to 50°C
- Output voltage control (R) and inhibit
- Output OK monitor
- Redundant operation and current sharing
- Extremely low inrush current, hot plug-in

Options:

- 9 Ambient temperature range
-40 to 71°C
- B1 Cooling plate
- P Potentiometer for Vout

Reduction of Hazardous Substances (RoHS)



In accordance with the full range of compliance options described in the European Union's RoHS Directive, Power-One is offering products in lead-free and lead-solder-exempted versions. This two-tiered strategy provides

customers with compliance choices that will not be offered by all power-system manufacturers. Please refer to the outside back cover of this brochure, or visit www.power-one.com for further details.

Q Series

60 to 132 Watt DC-DC converters

Output Adjustment Ranges

The following adjustment ranges apply to V1 and V2 outputs.

Vout	Low	High
3.3	3.3	3.3
5.1	4.1	5.6
12	7.2	13.2
15	9.0	16.5
24	14.4	26.4
48	28.8	52.8



6.5 x 4.4(3U) x 0.8(4 TE) inch
164 x 111 x 20 mm



CompactPCI, DC-DC & AC-DC

Unsigned output voltages are isolated and can be used as either + or - polarities.

Model	Power (Watts)	Height Profile	Input Voltage	+5V Current	+3.3V Current	+12V Current	-12V Current
CPD200-4530	200	3U	36-75 VDC	40 A	40 A	5.5 A	2 A
CPD250-4530	250	3U	36-75 VDC	40 A	40 A	5.5 A	2 A
CPA200-4530	200	3U	90-264 VAC	40 A	40 A	5.5 A	2 A
CPA250-4530	250	3U	90-264 VAC	40 A	40 A	5.5 A	2 A
CPA500-4530	500	6U	90-264 VAC	50 A	60 A	12 A	4 A

- Fully Compliant to CompactPCI Per PICMG Specifications
- High Density Design in an Industry Standard Package
- High Efficiency Topology (>80%)
- Remote Sense and Active Current Share for 3 Outputs
- Built-In ORing FETs for Redundant Applications
- AC-DC Models Have Active Power Factor Correction

Power-One's hot-swap CompactPCI power supplies are fully compliant to the PICMG 2.11 Power Interface Specification, and use a standard Positronic 47-pin connector. EDGE technology delivers up to 40 amperes on both the +5 and +3.3 volt outputs at 50°C on the 3U models, and 50 and 60 amperes respectively, on the 6U model's +5 and +3.3 volt outputs.

Remote sense and active current share on the +5, +3.3, and +12 volt outputs, along with ORing FETs facilitate use in redundant, hot-swap applications. These feature-rich products meet international safety standards, and display the CE Mark for the Low Voltage Directive (LVD).



CPD200/CPD250

3U x 8HP (8TE) x 6.3" (160mm)



CPA200/CPA250

3U x 8HP (8TE) x 6.3" (160mm)



CPA500

6U x 8HP (8TE) x 6.3" (160mm)

Power-One Increases Customers' Choices with RoHS Lead-Free and Lead-Solder-Exempted Products

In accordance with the full range of compliance options described in the European Union's RoHS Directive, Power-One is offering products in lead-free and lead-solder-exempted versions. This two-tiered strategy provides customers with compliance choices that will not be offered by all power-system manufacturers. This strategy also provides a migration path from lead-solder-exempted to lead-free products in the event that the lead-solder-exemption should expire when reviewed by the European Union in three years.



Power-One's RoHS-compliant lead-free-solder (comprised of tin, silver, and copper) process has been rigorously tested through 6,000 temperature cycles without any failures. Because there is still some industry concern regarding the long-term reliability of lead-free-solder joints in high-availability infrastructure applications, a number of companies,

especially in the communications industry, have chosen to exercise the lead-solder exemption at this time.

RoHS-compliance certificates are available at www.power-one.com by selecting the green "RoHS Update" link. Products designed for applications qualifying for the lead-solder exemption are certified as Power-One RoHS-5 (denoting reduction of five of the six listed substances). Lead-free products are certified as Power-One RoHS-6 (denoting reduction of all six substances).

All Power-One products are scheduled to be RoHS-5 compliant by the European Union's July 1, 2006 deadline, with most being completed before January 15, 2006. No special part number designations will be required when ordering RoHS-5 products. RoHS-6 compliant versions will be designated with a "G" in the part number suffix.

For more information on the European Union's RoHS Directive, and Power-One's compliance schedule, please visit www.power-one.com.



Please visit www.power-one.com for additional information.

Power-One, maXyz, No-Bus, Z-One, Z-One Digital IBA, and Z-POL are trademarks and/or logos of Power-One, Inc.