

MSTB 2,5/ 9-ST

Order No.: 1754588

The figure shows a 10-position version of the product

<http://eshop.phoenixcontact.de/phoenix/treeViewClick.do?UID=1754588>

Plug component, Nominal current: 12 A, Nom. voltage: 250 V, Pitch:
5 mm, Number of positions: 9, Connection type: Screw connection,
Color: green

Commercial data

EAN	4017918028756
Pack	50 pcs.
Customs tariff	85366990
Weight/Piece	0.01529 KG
Catalog page information	Page 198 (CC-2009)

Product notes

WEEE/RoHS-compliant since:
01/01/2003



<http://www.download.phoenixcontact.com>
Please note that the data given here has been taken from the online catalog. For comprehensive information and data, please refer to the user documentation. The General Terms and Conditions of Use apply to Internet downloads.

Technical data

Dimensions / positions

Pitch	5 mm
Dimension a	40 mm
Number of positions	9
Screw thread	M3

Tightening torque, min	0.5 Nm
Tightening torque max	0.6 Nm

Technical data

Insulating material group	I
Rated surge voltage (III/3)	4 kV
Rated surge voltage (III/2)	4 kV
Rated surge voltage (II/2)	4 kV
Rated voltage (III/2)	320 V
Rated voltage (II/2)	630 V
Connection in acc. with standard	EN-VDE
Nominal current I _N	12 A
Nominal voltage U _N	250 V
Nominal cross section	2.5 mm ²
Maximum load current	12 A (with 2.5 mm ² conductor cross section)
Insulating material	PA
Inflammability class acc. to UL 94	V0
Internal cylindrical gage	A3
Stripping length	7 mm

Connection data

Conductor cross section solid min.	0.2 mm ²
Conductor cross section solid max.	2.5 mm ²
Conductor cross section stranded min.	0.2 mm ²
Conductor cross section stranded max.	2.5 mm ²
Conductor cross section stranded, with ferrule without plastic sleeve min.	0.25 mm ²
Conductor cross section stranded, with ferrule without plastic sleeve max.	2.5 mm ²
Conductor cross section stranded, with ferrule with plastic sleeve min.	0.25 mm ²
Conductor cross section stranded, with ferrule with plastic sleeve max.	2.5 mm ²
Conductor cross section AWG/kcmil min.	24
Conductor cross section AWG/kcmil max	12
2 conductors with same cross section, solid min.	0.2 mm ²
2 conductors with same cross section, solid max.	1 mm ²

2 conductors with same cross section, stranded min.	0.2 mm ²
2 conductors with same cross section, stranded max.	1.5 mm ²
2 conductors with same cross section, stranded, ferrules without plastic sleeve, min.	0.25 mm ²
2 conductors with same cross section, stranded, ferrules without plastic sleeve, max.	1 mm ²
2 conductors with same cross section, stranded, TWIN ferrules with plastic sleeve, min.	0.5 mm ²
2 conductors with same cross section, stranded, TWIN ferrules with plastic sleeve, max.	1.5 mm ²

Certificates / Approvals



Certification

CB, CSA, CUL, GOST, UL, VDE-PZI

CSA

Nominal voltage U_N	300 V
Nominal current I_N	10 A
AWG/kcmil	28-12

CUL

Nominal voltage U_N	300 V
Nominal current I_N	10 A
AWG/kcmil	30-12

UL

Nominal voltage U_N	300 V
Nominal current I_N	10 A
AWG/kcmil	30-12

Accessories

Item	Designation	Description
General		
1733169	EBP 2- 5	Insertion bridge, fully insulated, for plug connectors with 5.0 or 5.08 mm pitch, no. of positions: 2
1783782	KGS-MSTB 2,5/ 9	Cable housing, Number of positions: 9, Dimension a: 45 mm, Color: green
Marking		
0804183	SK 5/3,8:FORTL.ZAHLEN	Marker card, printed horizontally, self-adhesive, 12 identical decades marked 1-10, 11-20 etc. up to 91-(99)100, sufficient for 120 terminal blocks
Plug/Adapter		
1734634	CP-MSTB	Keying profile, is inserted into the slot on the plug or inverted header, red insulating material
Tools		
1205053	SZS 0,6X3,5	Screwdriver, bladed, matches all screw terminal blocks up to 4.0 mm ² connection cross section, blade: 0.6 x 3.5 mm, without VDE approval

Additional products

Item	Designation	Description
General		
0707167	DFK-MSTB 2,5/ 9-G	Plug component, Nominal current: 12 A, Nom. voltage: 320 V, Nom. voltage: 320 V, Pitch: 5 mm, Number of positions: 9, Color: green, Assembly: Direct mounting
1899919	EMSTBA 2,5/ 9-G	Header, Nominal current: 12 A, Nom. voltage: 250 V, Pitch: 5 mm, Number of positions: 9, Assembly: Press-in
1914920	EMSTBVA 2,5/ 9-G	Header, Nominal current: 12 A, Nom. voltage: 200 V, Pitch: 5 mm, Number of positions: 9, Assembly: Press-in
1762761	MDSTB 2,5/ 9-G1	Header, Nominal current: 10 A, Nom. voltage: 250 V, Pitch: 5 mm, Number of positions: 9, Color: green, Assembly: Soldering
1846580	MDSTBA 2,5/ 9-G	Header, Nominal current: 10 A, Nom. voltage: 250 V, Pitch: 5 mm, Number of positions: 9, Assembly: Soldering
1762910	MDSTBV 2,5/ 9-G1	Header, Nominal current: 10 A, Nom. voltage: 250 V, Pitch: 5 mm, Number of positions: 9, Color: green, Assembly: Soldering
1845853	MDSTBVA 2,5/ 9-G	Header, Nominal current: 10 A, Nom. voltage: 250 V, Pitch: 5 mm, Number of positions: 9, Assembly: Soldering

1754575	MSTB 2,5/ 9-G	Header, Nominal current: 12 A, Nom. voltage: 250 V, Pitch: 5 mm, Number of positions: 9, Color: green, Assembly: Soldering
1768257	MSTB 2,5/ 9-G-LA	Header, Nominal current: 12 A, Nom. voltage: 250 V, Pitch: 5 mm, Number of positions: 9, Assembly: Soldering
1757530	MSTBA 2,5/ 9-G	Header, Nominal current: 12 A, Nom. voltage: 250 V, Pitch: 5 mm, Number of positions: 9, Color: green, Assembly: Soldering
1770559	MSTBA 2,5/ 9-G-LA	Header, Nominal current: 12 A, Nom. voltage: 250 V, Pitch: 5 mm, Number of positions: 9, Assembly: Soldering
1753576	MSTBV 2,5/ 9-G	Header, Nominal current: 12 A, Nom. voltage: 250 V, Pitch: 5 mm, Number of positions: 9, Color: green, Assembly: Soldering
1755587	MSTBVA 2,5/ 9-G	Header, Nominal current: 12 A, Nom. voltage: 250 V, Pitch: 5 mm, Number of positions: 9, Color: green, Assembly: Soldering
1736043	MSTBW 2,5/ 9-G	Header, Nominal current: 12 A, Nom. voltage: 250 V, Pitch: 5 mm, Number of positions: 9, Color: green, Assembly: Soldering
1769308	SMSTB 2,5/ 9-G	Header, Nominal current: 12 A, Nom. voltage: 250 V, Pitch: 5 mm, Number of positions: 9, Color: green, Assembly: Soldering
1769874	SMSTBA 2,5/ 9-G	Header, Nominal current: 12 A, Nom. voltage: 250 V, Pitch: 5 mm, Number of positions: 9, Color: green, Assembly: Soldering

Diagrams/Drawings

Dimensioned drawing

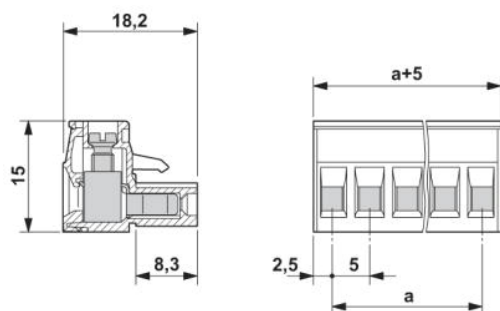

Address

PHOENIX CONTACT Deutschland GmbH
Flachmarktstr. 8
32825 Blomberg, Germany
Phone +49 5235 3 12000
Fax +49 5235 3 41200
<http://www.phoenixcontact.de>



© 2010 Phoenix Contact
Technical modifications reserved;