

SERPAC A-21

Electronics Enclosures

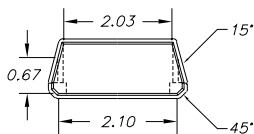

NOTES
1. WHEN MACHINE OR 1 PLATES MODIFICATIONS ARE REQUIRED, USE THE CENTER OF THE ENCLOSURE TO DIMENSION.

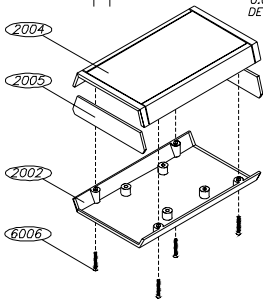
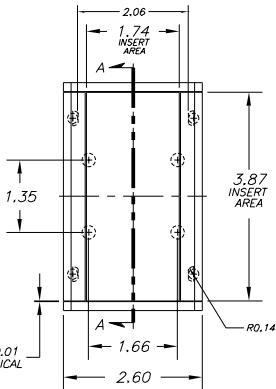
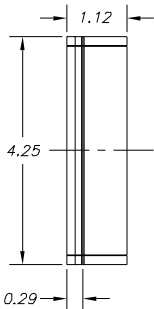
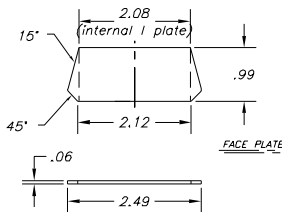
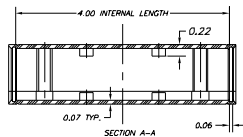
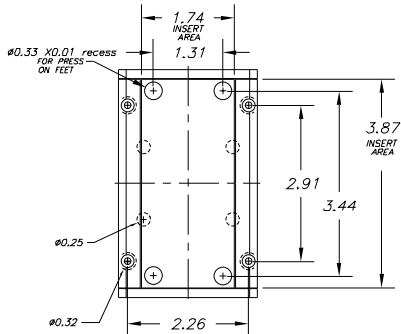

10-07-98

ALL DIMENSIONS ± .010

PART NO.	DESCRIPTION	PART NO.	ACCESSORIES
2004	PLASTIC TOP	52	PRESS ON FEET
2005	PLASTIC END PANEL	2005IR	INFRARED PANELS
2002	PLASTIC BOTTOM	2005CL	CLEAR & TRANSPARENT RED PANELS
6006	SCREW	2006	9 VOLT BATTERY ACCESS PANEL
		2007	PLASTIC BATTERY COVER
		2005DB9	9 PIN CONNECTOR
		2005DB25	25 PIN CONNECTOR