

Keywords: Carmel, MAXREFDES18, analog output, conditioner, programmable logic controllers (PLC), distributed control systems (DCS), industrial control and automation

SUBSYSTEM BOARD 5742

Carmel (MAXREFDES18#): High Accuracy Analog Current/Voltage Output

Sep 23, 2013

Abstract: The Carmel (MAXREFDES18#) subsystem reference design provides a high-accuracy analog current/voltage output in a compact, galvanically isolated form factor. This design uniquely fits programmable logic controllers (PLC), distributed control systems (DCS), and other industrial applications. Hardware and firmware design files and lab measurements are provided for rapid prototyping and development. The board is also available for purchase.

Introduction

In PLC and DCS systems, analog output currents and voltages provide critical control and actuation functions. The Carmel (MAXREFDES18#) reference design shown in **Figure 1** provides a flexible and programmable analog output that meets industrial control requirements.



[More detailed image \(JPG\)](#)

The buffered voltage output from the [MAX5316](#) 16-bit, high-accuracy digital-to-analog converter (DAC) drives the input of the [MAX15500](#), a programmable analog output conditioner with extensive error reporting. The [MAX6126](#) ultra-high-precision voltage reference provides references for the DAC and the output conditioner. The [MAX14850](#) galvanically isolates data communication between the subsystem and the system controller. Optionally, the subsystem also integrates an isolated and regulated power supply by using the [MAX13253](#) transformer driver and the [MAX1659](#) and [MAX1735](#) low-dropout (LDO) linear regulators.

The subsystem features all typical bipolar current and voltage output ranges, and appropriate subsets, with less than 0.105% total unadjusted error (TUE). The circuit also provides short-circuit and overcurrent protection, open circuit detection, brownout detection, overtemperature protection, all of which are critical for industrial applications. Flexible power-up options make Carmel an ideal choice for robust industrial control systems.

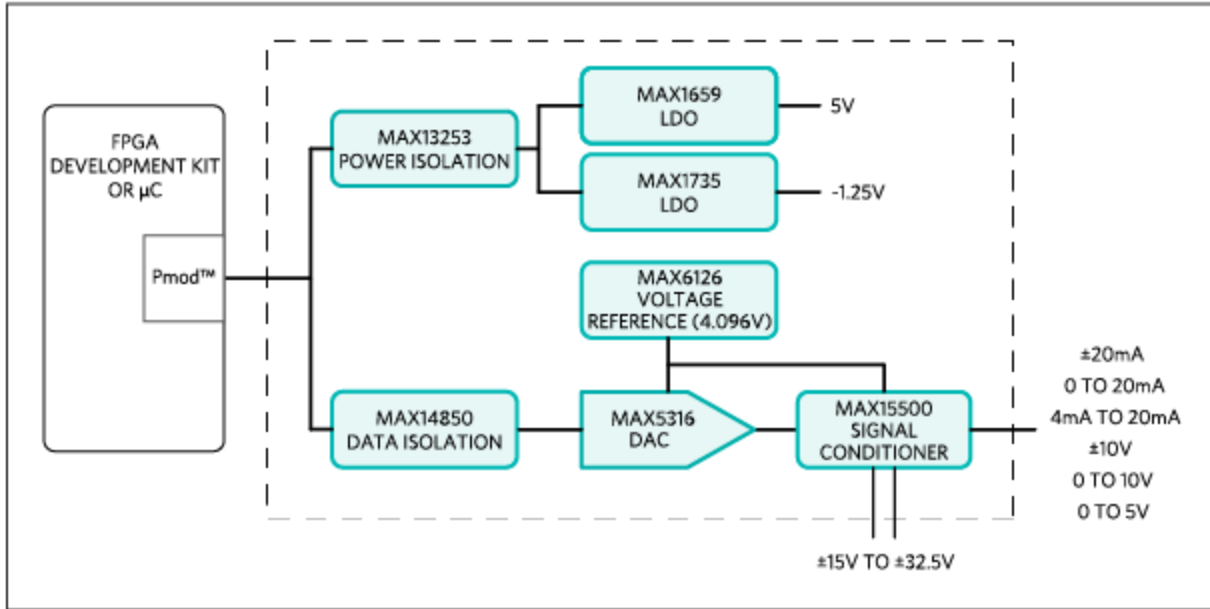

Figure 1. The Carmel subsystem design block diagram.

Features

- Programmable high-accuracy current/voltage output
- Current output drives 0 to 1k Ω
- Voltage output drives loads down to 1k Ω
- Extensive error reporting
- Isolated power and data
- Small printed circuit board (PCB) area
- Device drivers
- Example C source code
- Pmod™-compatible form factor

Applications

- PLCs
- DCS
- Distributed I/Os
- Embedded systems
- Industrial control and automation
- Industrial sensors

Competitive Advantages

- Flexibility
- System safety
- Small solution size
- Low cost

Detailed Description of Hardware

Carmel connects to Pmod-compatible field-programmable gate array (FPGA)/microcontroller development boards. Carmel requires a 3.3V supply voltage from the Pmod connector and uses the SPI pin assignments as illustrated here.

The power requirements are shown in **Table 1**. Note that the external AVDD and AVSS power rails are required for full system operation. The currently supported platforms and ports are shown in **Table 2**.

Table 1. Power Requirements for the Carmel Subsystem Reference Design			
Power Name	Jumper Shunt	Input Voltage (V)	Input Current (mA, max)
3.3V Pmod Power Supply	JU4: 1-2	3.3	49.0
AVDD	—	15.0 to 32.5	25.0
AVSS	—	-15.0 to -32.5	25.0

Table 2. Supported Platforms and Ports	
Supported Platforms	Ports
LX9 platform (Spartan®-6)	J5
ZedBoard platform (Zynq®-7020)	JA1

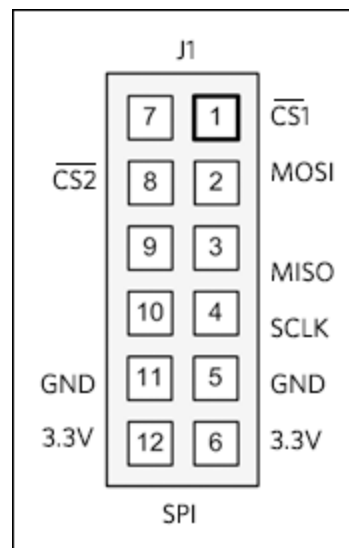

The MAX15500 (U1) is a single-channel, low-cost, precision analog current/voltage output conditioner developed to meet the requirements of PLCs and other industrial control and automation applications. The MAX15500 operates from a $\pm 15V$ to $\pm 32.5V$ power-supply range.

The MAX15500 can generate both unipolar and bipolar current and voltage outputs. In current mode, the device produces currents of $-1.2mA$ to $+24mA$ or $-24mA$ to $+24mA$. In voltage mode, the device produces voltages of $-0.3V$ to $+6V$, $-0.6V$ to $+12V$, or $\pm 12V$. To allow for overrange and underrange capability in unipolar mode, the transfer function of the MAX15500 is offset so that when the voltage at AIN is 5% of full scale, IOU is 0mA and VOUT is 0V. Once VAIN attains full scale, VOUT or IOU becomes full scale +5% or +20% depending on the state of FSMODE.

The MAX15500 protects against overcurrent and short-circuit conditions when OUT goes to ground or a voltage up to $\pm 32.5V$. The device also monitors for overtemperature and supply brownout conditions. The supply brownout threshold is programmable between $\pm 10V$ and $\pm 24V$ in 2V increments. The MAX15500 provides extensive error reporting of short-circuit, open-circuit, brownout, and overtemperature conditions through the SPI interface and an additional open-drain interrupt output (ERROR). The MAX15500 also includes an analog 0 to 3V output (MON) to monitor the load condition at OUT.

The MAX5316 (U2) is a high-accuracy, 16-bit, buffered voltage-output DAC. The device features ± 1 LSB integral nonlinearity (INL) (max) accuracy and a ± 1 LSB differential nonlinearity (DNL) (max) accuracy over the -40°C to $+105^{\circ}\text{C}$. A separate -1.25V AVSS supply allows the output amplifier to go to 0V (GND) while maintaining full linearity performance. For lower deadband requirements, the feature-reduced MAX5216 DAC can be used instead.

The MAX6126 (U3) drives the analog output conditioner and the DAC's reference input with an ultra-high-precision 4.096V voltage reference with 0.02% initial accuracy and a $3\text{ppm}/^{\circ}\text{C}$ maximum temperature coefficient (tempco).

The DAC's output directly drives the conditioner's input with no external components, making the interface simple.

The MAX13253 (U4) provides an isolated, functional insulation class power solution that accepts 3.3V and converts it to $\pm 6\text{V}$ using an isolation transformer. Post-regulation is accomplished using the MAX1659 LDO (U5) for the 5V output, and the MAX1735 (U6) for the -1.25V output.

Data isolation between the subsystem and the controller is accomplished using the MAX14850 (U7) digital data isolator. The combined power and data isolation achieved is 600V_{RMS} .

Detailed Description of Firmware for LX9 and ZedBoard Platforms

Table 2 shows the currently supported platforms and ports. Support for additional platforms may be added periodically under Firmware Files in the All Design Files section.

The Carmel firmware released for the LX9 development kit targets a Microblaze™ soft-core microcontroller placed inside a Xilinx® Spartan®-6 FPGA. The Carmel firmware also supports the ZedBoard kit and targets an ARM® Cortex®-A9 processor placed inside a Xilinx Zynq system-on-chip (SoC).

The firmware is a working example of how to initiate the system and wait for a user's input. A user can select the output mode and type in the DAC input code. The simple process flow is shown in **Figure 2**. The firmware is written in C using the Xilinx software development kit (SDK) tool, which is based on the Eclipse™ open source standard. Custom Carmel-specific design functions were created utilizing the standard Xilinx XSpi core version 3.03a. The SPI clock frequency is set to 3.125MHz .

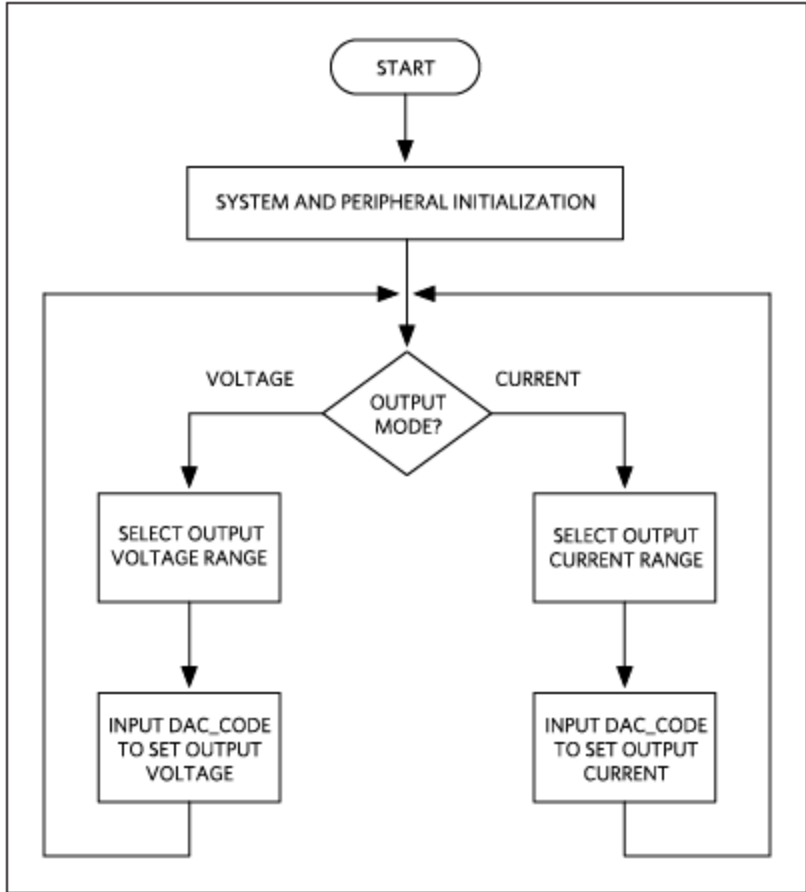

Figure 2. The Carmel firmware flowchart.

The complete source code is provided to speed up customer development. Code documentation can be found with the corresponding firmware platform files.

Quick Start

Required equipment:

- Windows® PC with two USB ports
- Carmel (MAXREFDES18#) board
- Carmel-supported platform (i.e., LX9 development kit or ZedBoard kit)
- One $\pm 24V$, 25mA minimum DC power supply
- One 750 Ω , 0.25W resistor

Download, read, and carefully follow each step in the appropriate Carmel Quick Start Guide:

[Carmel \(MAXREFDES18#\) LX9 Quick Start Guide](#)

[Carmel \(MAXREFDES18#\) ZedBoard Quick Start Guide](#)

Lab Measurements

Equipment:

- Carmel (MAXREFDES18#) board
- FPGA development kit
- One 750Ω, 0.25W resistor load
- Agilent 3458A digital multimeter
- Agilent E3631A DC power supply (any ±24V, 25mA minimum DC power supply works)
- National Instruments GPIB card and cable
- Thermonics T-2800 precision temperature forcing system
- Perl script for controlling the FPGA development kit and measurement equipment
- Windows PC

INL, DNL, and total unadjusted error (TUE) are the most important specifications for PLC and other process control systems. The MAX15500 is highly flexible and configurable to meet the needs of various applications. Measurements of DNL, INL, and output error for the reference design are shown in **Figure 3**, **Figure 4**, and **Figure 5**, respectively. The data was taken at +25°C in the -10V to +10V voltage output mode, with 5% overrange.

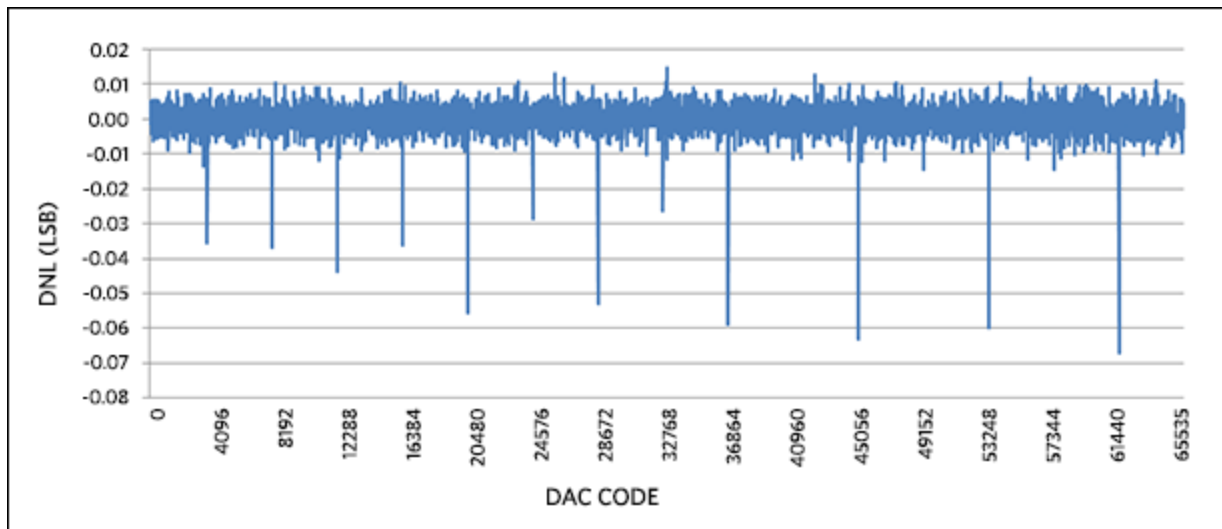

Figure 3. DNL for -10V to +10V output range, with 5% overrange.

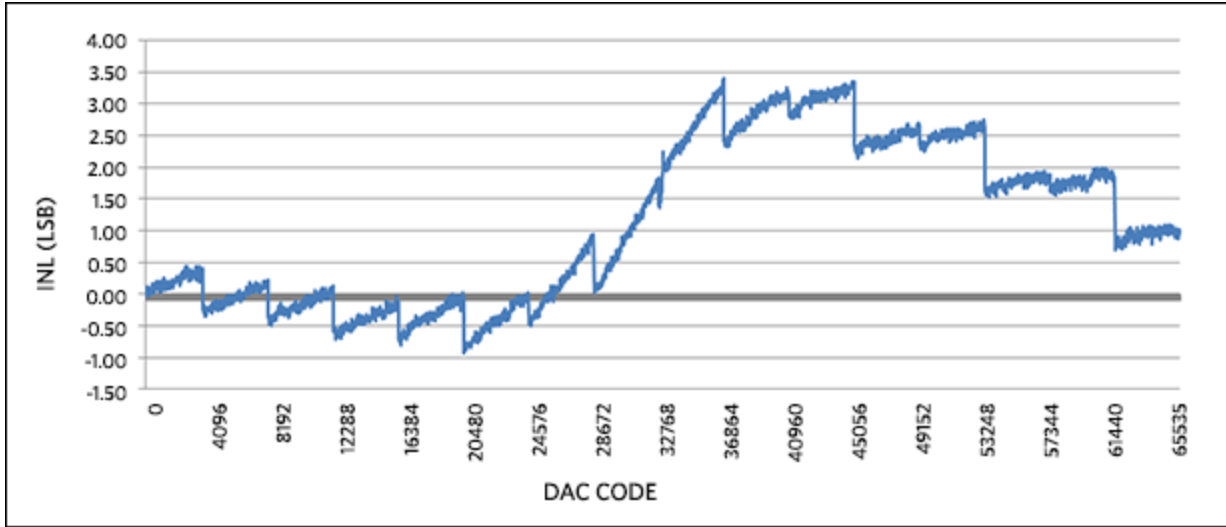

Figure 4. INL for -10V to +10V output range, with 5% overrange.

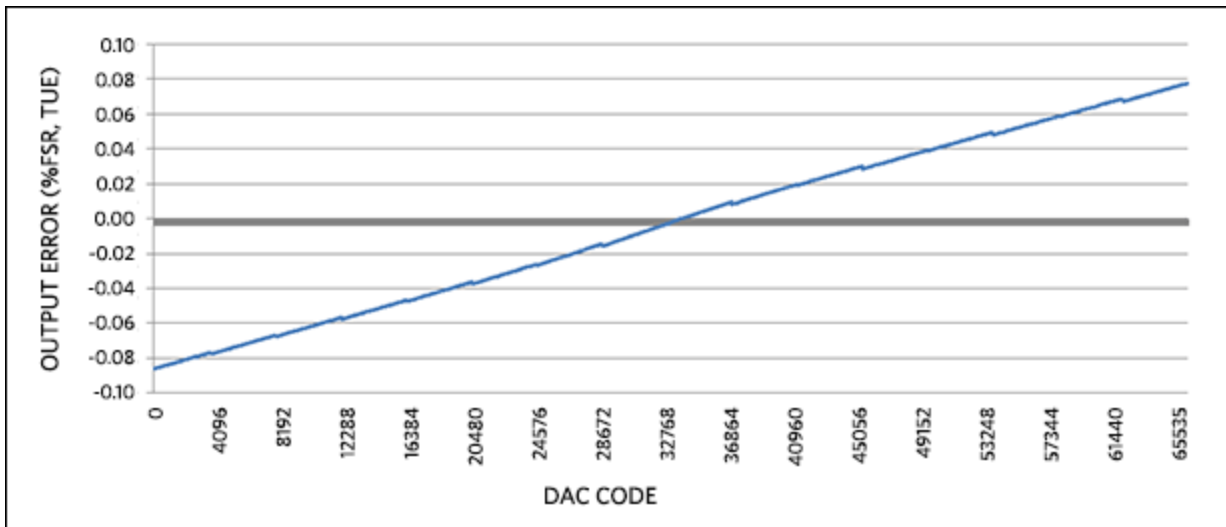

Figure 5. Output error for -10V to +10V output range, with 5% overrange.

In the case of current output, DNL, INL, and output error (without calibration) for the reference design are shown in **Figure 6**, **Figure 7**, and **Figure 8**, respectively. The data was taken at +25°C in the 0mA to 20mA current output mode, with 5% overrange.

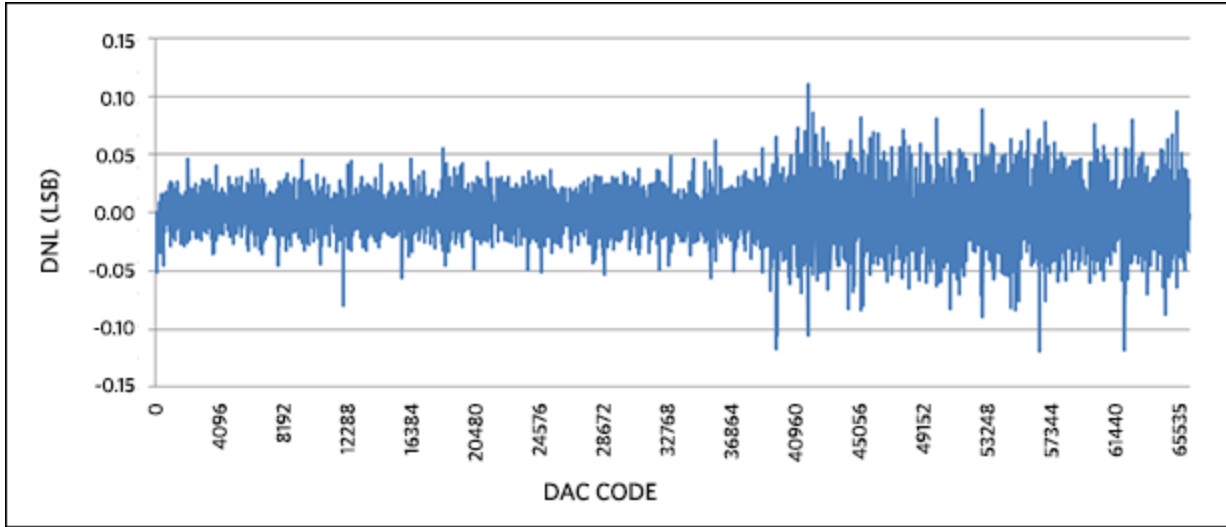

Figure 6. DNL for 0 to 20mA output range, with 5% overrange.

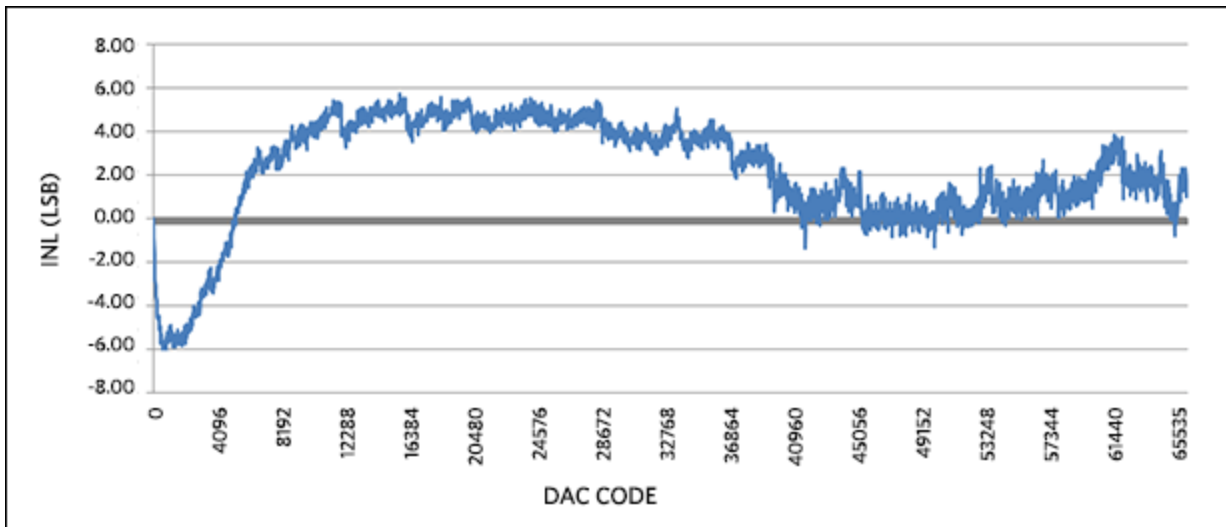

Figure 7. INL for 0 to 20mA output range, with 5% overrange.

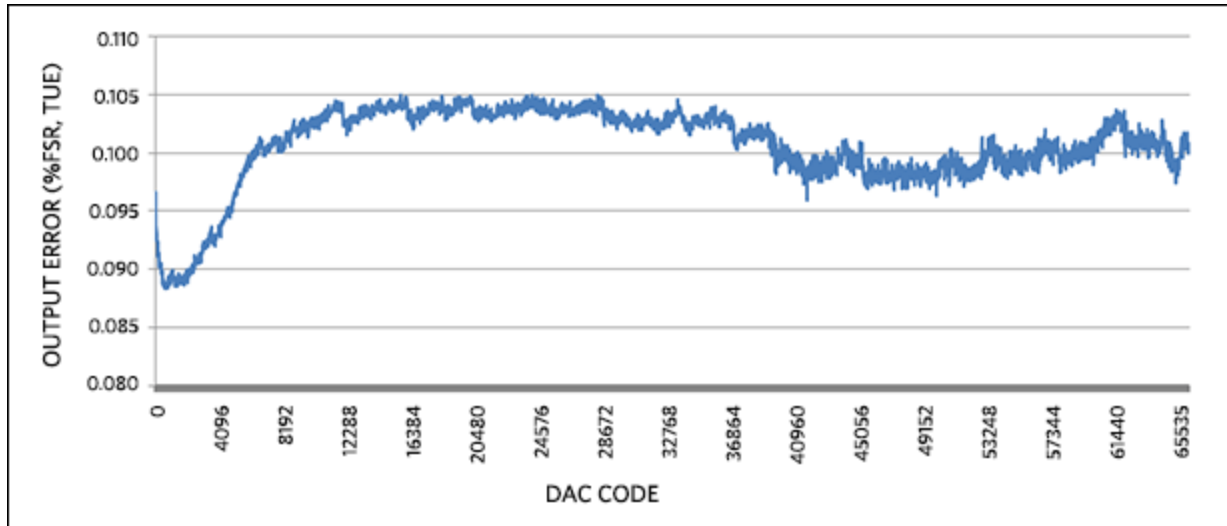

Figure 8. Output error for 0 to 20mA output range, with 5% overrange.

All Design Files

[Download All Design Files](#)

Hardware Files

- [Schematic](#)
- [Bill of materials \(BOM\)](#)
- [PCB layout](#)
- [PCB Gerber](#)
- [PCB CAD \(PADS 9.0\)](#)

Firmware Files

- [LX9 Platform \(Spartan-6\)](#)
- [ZedBoard Platform \(Zynq-7000\)](#)

Buy Reference Design

Buy Direct: [Carmel \(MAXREFDES18#\)](#)

Or

Order the Carmel reference design (MAXREFDES18#) from your local Maxim representative.

ARM is a registered trademark and registered service mark of ARM Limited.

Cortex is a registered trademark of ARM Limited.

Eclipse is a trademark of Eclipse Foundation, Inc.

Halo is a registered trademark of Halo Electronics, Inc.

MicroBlaze is a trademark of Xilinx, Inc.

Pmod is a trademark of Digilent Inc.

Spartan is a registered trademark of Xilinx, Inc.

Windows is a registered trademark and registered service mark of Microsoft Corporation.

Xilinx is a registered trademark and registered service mark of Xilinx, Inc.

ZedBoard is a trademark of ZedBoard.org.

Zynq is a registered trademark of Xilinx, Inc.

Related Parts

MAX13253	1A Spread-Spectrum Push-Pull Transformer Driver for Isolated Power Supplies	Free Samples
MAX14850	Six-Channel Digital Isolator	
MAX15500	Industrial Analog Current/Voltage Output Conditioners	Free Samples
MAX1659	350mA, 16.5V Input, Low-Dropout Linear Regulators	Free Samples
MAX1735	200mA, Negative-Output, Low-Dropout Linear Regulator in SOT23	Free Samples
MAX5316	16-Bit, ± 1 LSB Accuracy Voltage Output DAC with SPI Interface	Free Samples
MAX6126	Ultra-High-Precision, Ultra-Low-Noise, Series Voltage Reference	Free Samples

More Information

For Technical Support: <http://www.maximintegrated.com/support>

For Samples: <http://www.maximintegrated.com/samples>

Other Questions and Comments: <http://www.maximintegrated.com/contact>

Application Note 5742: <http://www.maximintegrated.com/an5742>

SUBSYSTEM BOARD 5742, AN5742, AN 5742, APP5742, Appnote5742, Appnote 5742

© 2013 Maxim Integrated Products, Inc.

Additional Legal Notices: <http://www.maximintegrated.com/legal>