

STRADA-DW

Soft wide beam with good illuminance uniformity optimized for CREE XP-G and XP-E. Assembly with installation tape.

TECHNICAL SPECIFICATIONS:

Dimensions	19.6 x 15.5 mm
Height	9 mm
Fastening	tape, pin, screw
Colour	clear
Box size	
Box weight	4.3 kg
Quantity in Box	3120 pcs
ROHS compliant	yes ⓘ



MATERIAL SPECIFICATIONS:

Component	Type	Material	Colour
STRADA-DW	Lens	PMMA	clear
VOSU-WU-M-365-TAPE	Tape		

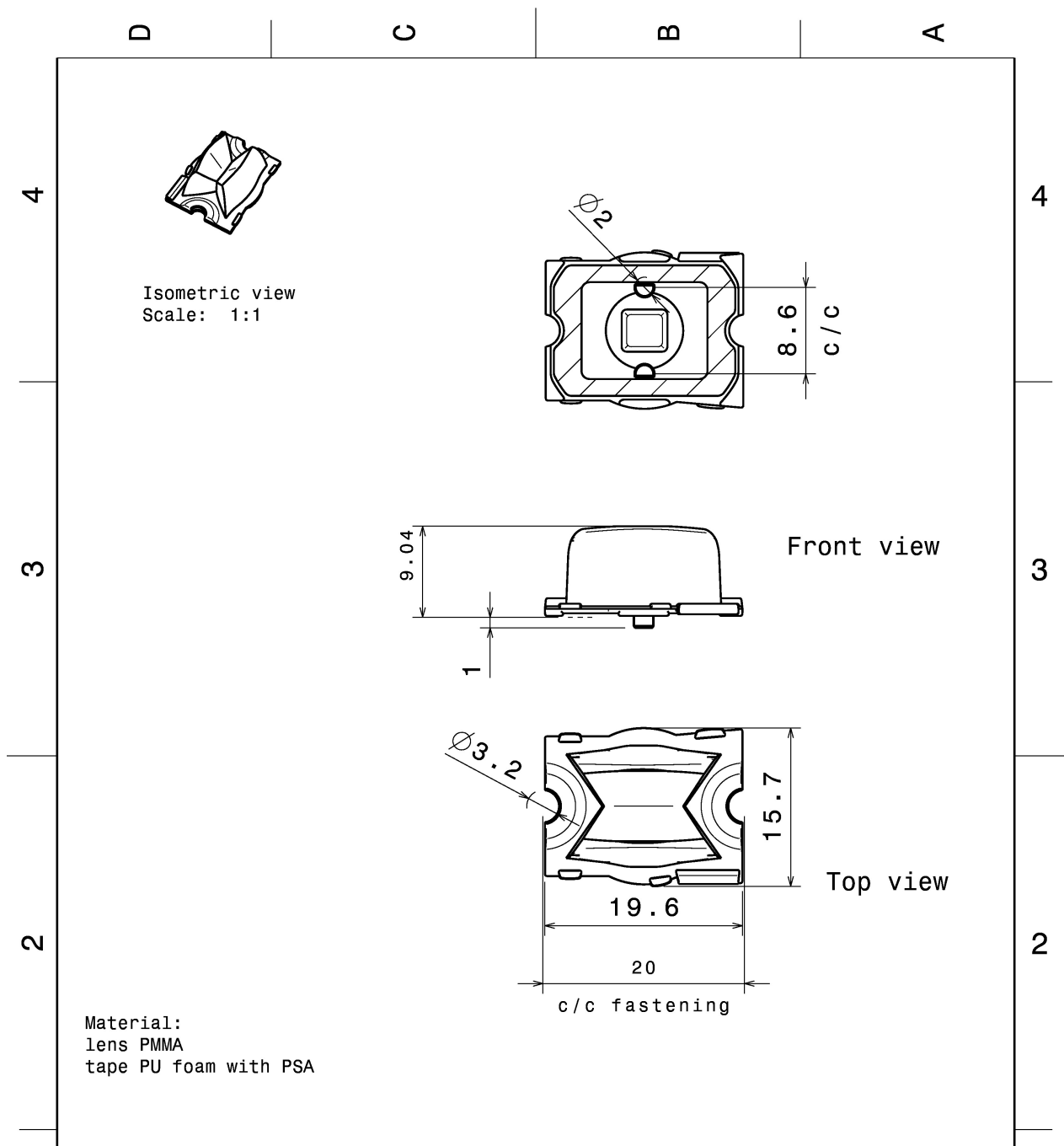

Material:
lens PMMA
tape PU foam with PSA

This drawing is our property.
It can't be reproduced
or communicated without
our written agreement.



L
T
F
F

e
e
i
i
n
n

d

DRAWN BY p		DATE 14.01.2010	DRAWING TITLE Datasheet Strada-DW assy			
CHECKED BY i k	DATE 01.12.2009	SIZE A4	DRAWING NUMBER CA11256		REV 1	
DESIGNED BY hh	DATE 01.12.2009	SCALE 2:1	WEIGHT (g)	SHEET 1/1		

PHOTOMETRIC DATA (MEASURED):



LED XP-E
FWHM 90.0 + 140.0°
Efficiency 92 %
Peak intensity 1.030 cd/lm
Required components:

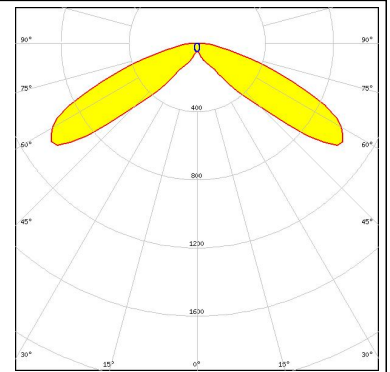

LED XP-G
FWHM 88.0 + 148.0°
Efficiency 92 %
Peak intensity 0.840 cd/lm
Required components:

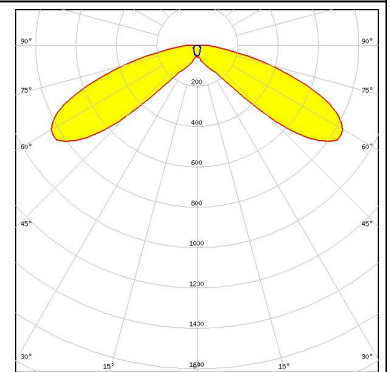

LED H35C0 (LEMWA33)
FWHM 86.0 + 147.0°
Efficiency 94 %
Peak intensity 0.900 cd/lm
Required components:



LED LUXEON A
FWHM 86.0 + 140.0°
Efficiency 92 %
Peak intensity cd/lm
Required components:

PHOTOMETRIC DATA (MEASURED):

LUMILEDS

LED LUXEON Rebel
FWHM 86.0 + 140.0°
Efficiency 92 %
Peak intensity 1.010 cd/lm
Required components:

LUMILEDS

LED LUXEON Rebel ES
FWHM 86.0 + 140.0°
Efficiency 92 %
Peak intensity cd/lm
Required components:

LUMILEDS

LED LUXEON T
FWHM 86.0 + 144.0°
Efficiency 93 %
Peak intensity 0.900 cd/lm
Required components:

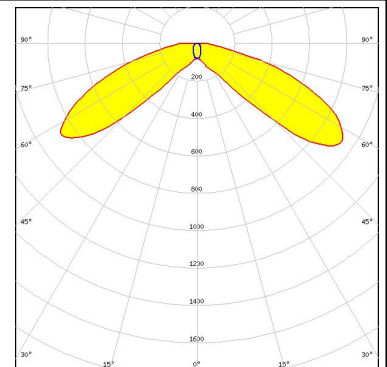

LUMILEDS

LED LUXEON TX
FWHM 54.0 + 144.0°
Efficiency 94 %
Peak intensity 0.980 cd/lm
Required components:

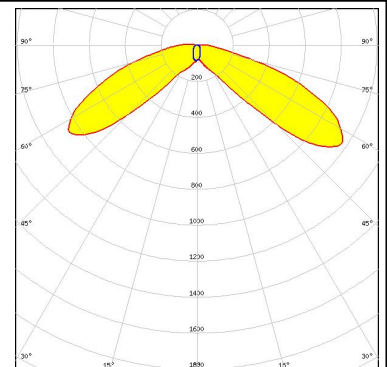

PHOTOMETRIC DATA (MEASURED):



LED NCSxx19A
FWHM 86.0 + 148.0°
Efficiency 92 %
Peak intensity cd/lm
Required components:



LED NVSW219D
FWHM 141.0 + 57.0°
Efficiency 94 %
Peak intensity 0.890 cd/lm
Required components:

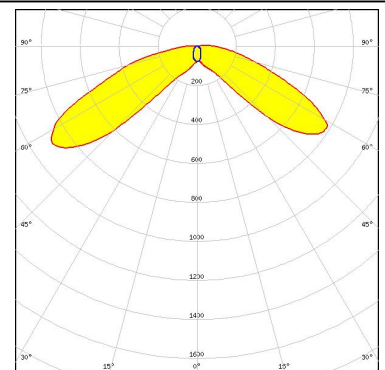

LED NVSxx19A
FWHM 86.0 + 148.0°
Efficiency 92 %
Peak intensity cd/lm
Required components:



LED Oslon SSL 150
FWHM 92.0 + 142.0°
Efficiency 92 %
Peak intensity cd/lm
Required components:

PHOTOMETRIC DATA (MEASURED):

OSRAM
Opto Semiconductors

LED Oslon SSL 80
FWHM 92.0 + 142.0°
Efficiency 92 %
Peak intensity 0.970 cd/lm
Required components:

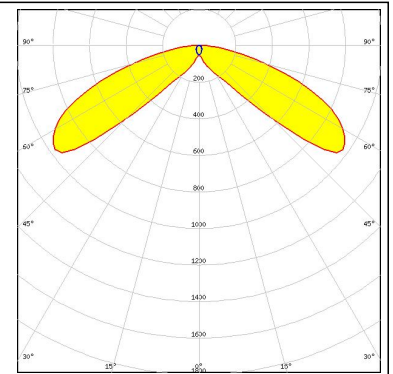

PHOTOMETRIC DATA (SIMULATED):



LED XP-E2
FWHM 87.0 + 135.0°
Efficiency 94 %
Peak intensity 1.450 cd/lm
Required components:

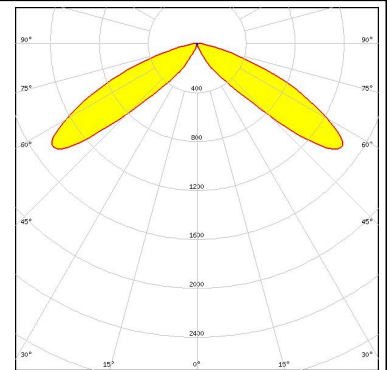

LED LUXEON H50-2
FWHM 80.0 + 136.0°
Efficiency 93 %
Peak intensity 1.100 cd/lm
Required components:

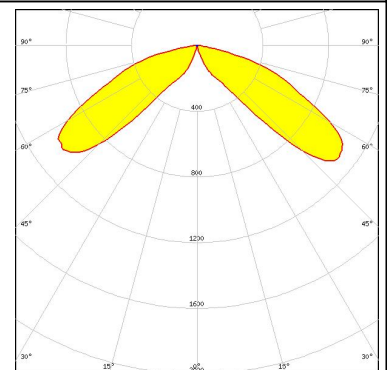

LED NVSxx19B/NVSxx19C
FWHM 80.0 + 140.0°
Efficiency 94 %
Peak intensity 1.047 cd/lm
Required components:

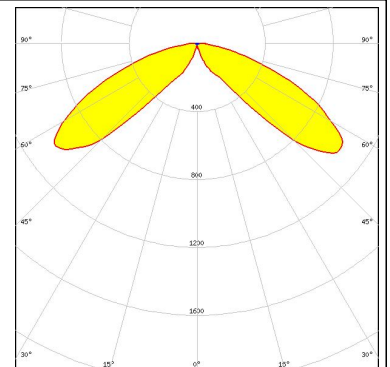

SEOUL SEMICONDUCTOR

LED Z5
FWHM 86.0 + 141.0°
Efficiency %
Peak intensity cd/lm
Required components:

PHOTOMETRIC DATA (SIMULATED):

SHARP

LED	Double Dome (GM2BB)
FWHM	86.0 + 141.0°
Efficiency	%
Peak intensity	cd/lm
Required components:	

GENERAL INFORMATION:

NOTE: The typical beam angle will be changed by different color, chip size and chip position tolerance. The typical total beam angle is the full angle measured where the luminous intensity is half of the peak value.

MATERIALS:

As part of our continuous research and improvement processes, and to ensure the best possible quality and availability of our products, LEDiL reserves the right to change material grades without notice.

PRODUCT DATA USER AGREEMENT AND DISCLAIMER:

The measured data in the provided downloadable LEDiL Product Datasheets and Mechanical 2D-Drawings is rounded and provided as reference for planning. LEDiL Oy's optical specifications have been verified by conducting performance testing of the products in accordance with the company's quality system. The reported data are averaged results of multiple measurements with typical variation. LEDiL Oy reserves the right to without prior notification make changes and improvements to its products.

LEDiL Oy assumes neither warranty, nor guarantee nor any other liability of any kind for the contents and correctness of the provided data. The provided data has been generated with highest diligence but the provided data may in reality not represent the complete possible variation range of all intrinsic parameters. Therefore, in certain cases a deviation from the provided data could occur.

LEDiL Oy reserves the right to undertake technical changes of its products without further notification which could lead to changes in the provided data. LEDiL Oy assumes no liability of any kind for the possible deviation from any provided data or any other damage resulting from the usage of the provided data.

The user agrees to this disclaimer and user agreement with the download or usage of the provided files.

LEDiL Oy

Joensuunkatu 13
FI-24240 SALO
Finland

LEDiL Inc.

228 West Page Street
Suite D
Sycamore IL 60178
USA

Local sales and technical support

[www.ledil.com/
where_to_buy](http://www.ledil.com/where_to_buy)

Shipping locations

Salo, Finland
Hong Kong, China

Distribution Partners

[www.ledil.com/
where_to_buy](http://www.ledil.com/where_to_buy)