

## DC MOTOR 2 click

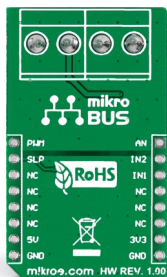
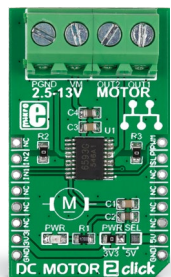

### 1. Introduction

DC MOTOR 2 click carries the TB6593FNG driver IC for direct current motors. With two pairs of screw terminals (power supply and outputs), the click board can drive motors with voltages from 2.5 to 13V [output current of up to 1.2 amps with peaks up to 3.2 amps]. DC MOTOR 2 click communicates with the target microcontroller through mikroBUS™ PWM, INT [here SLP], RST and CS pins [here IN2 and IN1]. The board can use either a 3.3V or a 5V power supply.

### 2. Soldering the headers

Before using your click board™, make sure to solder 1x8 male headers to both left and right side of the board. Two 1x8 male headers are included with the board in the package.

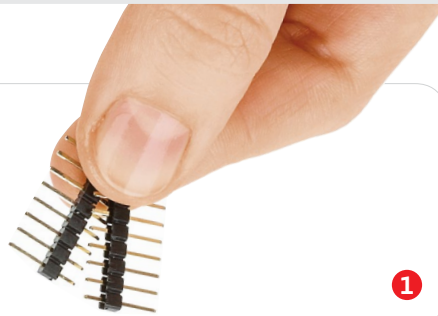

1

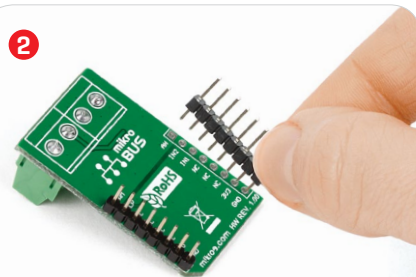

Turn the board upside down so that the bottom side is facing you upwards. Place shorter pins of the header into the appropriate soldering pads.

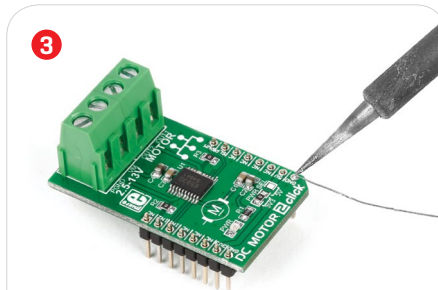

Turn the board upward again. Make sure to align the headers so that they are perpendicular to the board, then solder the pins carefully.

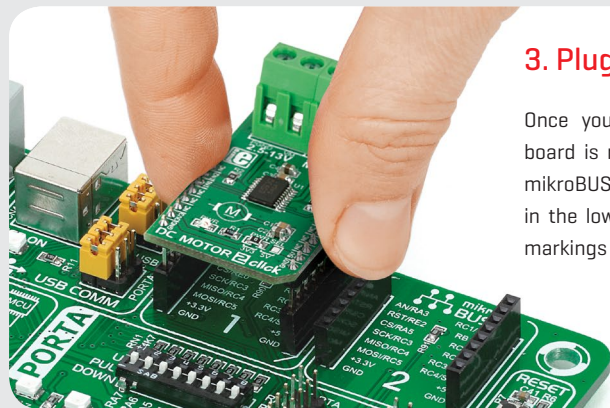

### 3. Plugging the board in

Once you have soldered the headers your board is ready to be placed into the desired mikroBUS™ socket. Make sure to align the cut in the lower-right part of the board with the markings on the silkscreen at the mikroBUS™ socket. If all the pins are aligned correctly, push the board all the way into the socket.

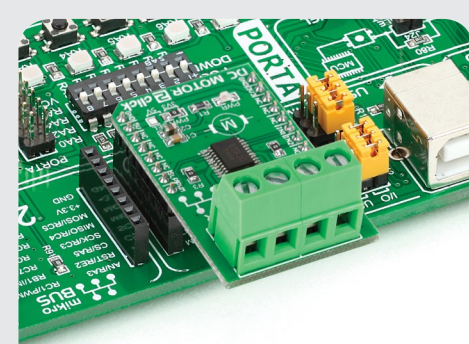

### 4. Essential features

The PWM signal drives the motor while the IN1 and IN2 pins provide binary direction signals that set the direction of the motor [clockwise or counter clockwise], or apply stop or short break functions. Stop mode cuts off the power supply so the motor continues spinning until it runs out of momentum. Short break brings it to an abrupt stop [it also blocks the rotor so it resists spinning even when external momentum is applied]. The Standby is power saving, putting the chip in sleep mode when in low logic level.

**click**  
BOARD™  
[www.mikroe.com](http://www.mikroe.com)



DC Motor 2 click manual  
ver 1.00



010000081402

## 5. Schematic

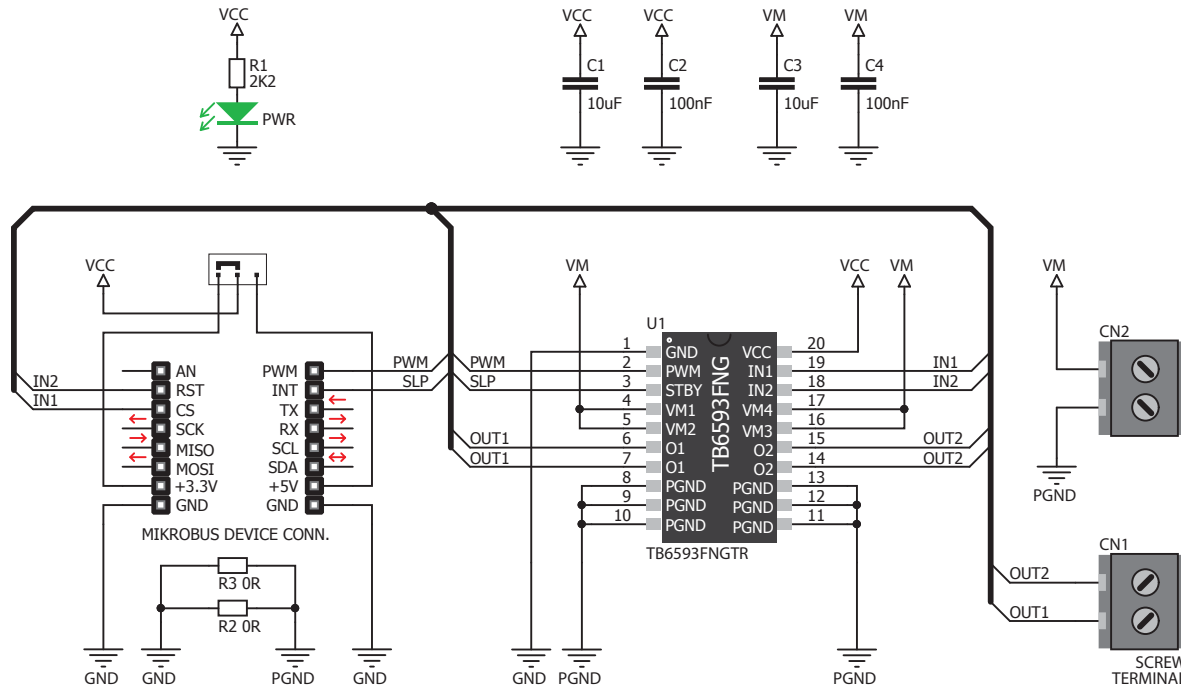

## 6. Dimensions

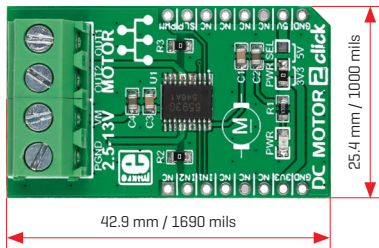

	mm	mils
LENGTH	42.9	1690
WIDTH	25.4	1000
HEIGHT*	17.5	689

\* without headers

## 7. SMD jumper

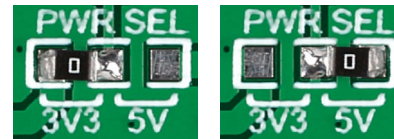

DC MOTOR 2 click features an SMD jumper [zero ohm resistor] that let's you switch between a 3.3V or a 5V power supply.

## 8. Code examples

Once you have done all the necessary preparations, it's time to get your click board™ up and running. We have provided examples for mikroC™, mikroBasic™ and mikroPascal™ compilers on our **Libstock** website. Just download them and you are ready to start.



## 9. Support

MikroElektronika offers **free tech support** [[www.mikroe.com/support](http://www.mikroe.com/support)] until the end of the product's lifetime, so if something goes wrong, we're ready and willing to help!



## 10. Disclaimer

MikroElektronika assumes no responsibility or liability for any errors or inaccuracies that may appear in the present document. Specification and information contained in the present schematic are subject to change at any time without notice.

Copyright © 2015 MikroElektronika.  
All rights reserved.