

# **STM32-P407 development board** **USER'S MANUAL**

Revision D, May 2014  
Designed by OLIMEX Ltd, 2011



All boards produced by Olimex LTD are ROHS compliant

**Disclaimer:**

© 2014 Olimex Ltd. Olimex®, logo and combinations thereof, are registered trademarks of Olimex Ltd. Other product names may be trademarks of others and the rights belong to their respective owners.

**The information in this document is provided in connection with Olimex products. No license, express or implied or otherwise, to any intellectual property right is granted by this document or in connection with the sale of Olimex products.**

The hardware and the software files are proprietary design and would not be distributed nor shared.

It is possible that the pictures in this manual differ from the latest revision of the board.

The product described in this document is subject to continuous development and improvements. All particulars of the product and its use contained in this document are given by OLIMEX in good faith. However all warranties implied or expressed including but not limited to implied warranties of merchantability or fitness for purpose are excluded. This document is intended only to assist the reader in the use of the product. OLIMEX Ltd. shall not be liable for any loss or damage arising from the use of any information in this document or any error or omission in such information or any incorrect use of the product.

This product is intended for use for engineering development, demonstration, or evaluation purposes only and is not considered by OLIMEX to be a finished end-product fit for general consumer use. Persons handling the product must have electronics training and observe good engineering practice standards. As such, the goods being provided are not intended to be complete in terms of required design-, marketing-, and/or manufacturing-related protective considerations, including product safety and environmental measures typically found in end products that incorporate such semiconductor components or circuit boards.

Olimex currently deals with a variety of customers for products, and therefore our arrangement with the user is not exclusive. Olimex assumes no liability for applications assistance, customer product design, software performance, or infringement of patents or services described herein.

**THERE IS NO WARRANTY FOR THE DESIGN MATERIALS AND THE COMPONENTS USED TO CREATE STM32-P407. THEY ARE CONSIDERED SUITABLE ONLY FOR STM32-P407.**

## Table of Contents

<b>CHAPTER 1 OVERVIEW</b> .....	<b>5</b>
<b>1. Introduction to the chapter</b> .....	<b>5</b>
<b>1.1 Features</b> .....	<b>5</b>
<b>1.2 Organization</b> .....	<b>6</b>
<b>CHAPTER 2 SETTING UP THE STM32-P407 BOARD</b> .....	<b>7</b>
<b>2. Introduction to the chapter</b> .....	<b>7</b>
<b>2.1 Electrostatic warning</b> .....	<b>7</b>
<b>2.2 Requirements</b> .....	<b>7</b>
<b>2.3 Powering the board</b> .....	<b>8</b>
<b>2.4 Prebuilt software</b> .....	<b>8</b>
<b>CHAPTER 3 STM32-P407 BOARD DESCRIPTION</b> .....	<b>9</b>
<b>3. Introduction to the chapter</b> .....	<b>9</b>
<b>3.1 Layout (top view)</b> .....	<b>9</b>
<b>3.2 Layout (bottom view)</b> .....	<b>10</b>
<b>CHAPTER 4 THE STM32F407ZGT6 MICROCONTROLLER</b> .....	<b>11</b>
<b>4. Introduction to the chapter</b> .....	<b>11</b>
<b>4.1 The microcontroller</b> .....	<b>11</b>
<b>5. Introduction to the chapter</b> .....	<b>13</b>
<b>5.1 Reset</b> .....	<b>13</b>
<b>5.2 Clock</b> .....	<b>13</b>
<b>CHAPTER 6 HARDWARE</b> .....	<b>14</b>
<b>6. Introduction to the chapter</b> .....	<b>14</b>
<b>6.1 JTAG connector</b> .....	<b>14</b>
<b>6.2 UEXT</b> .....	<b>15</b>
<b>6.3 Pads on the proto area</b> .....	<b>16</b>
<b>6.4 USB OTG</b> .....	<b>17</b>
<b>6.5 USB HOST</b> .....	<b>17</b>
<b>6.6 LAN connector</b> .....	<b>17</b>
<b>6.7 PWR Jack</b> .....	<b>18</b>
<b>6.8 Headphones connector</b> .....	<b>18</b>
<b>6.9 SD/MMC slot</b> .....	<b>18</b>
<b>6.10 RS232 1</b> .....	<b>19</b>
<b>6.11 RS232 2</b> .....	<b>20</b>
<b>6.12 CAN connector</b> .....	<b>20</b>
<b>6.13 Battery connector</b> .....	<b>20</b>
<b>6.14 Jumper description</b> .....	<b>21</b>
<b>6.15 LCD Display with backlight</b> .....	<b>23</b>

---

<b><u>6.16 VGA Color Camera.....</u></b>	<b><u>23</u></b>
<b><u>6.17 Additional hardware components.....</u></b>	<b><u>23</u></b>
<b><u>6.18 Notes on interfaces.....</u></b>	<b><u>23</u></b>
<b><u>CHAPTER 7 MEMORY.....</u></b>	<b><u>25</u></b>
<b><u>7. Introduction to the chapter.....</u></b>	<b><u>25</u></b>
<b><u>7.1 Memory map.....</u></b>	<b><u>26</u></b>
<b><u>CHAPTER 8 SCHEMATICS.....</u></b>	<b><u>27</u></b>
<b><u>8. Introduction to the chapter.....</u></b>	<b><u>27</u></b>
<b><u>8.1 Eagle schematic.....</u></b>	<b><u>27</u></b>
<b><u>8.2 Physical dimensions.....</u></b>	<b><u>29</u></b>
<b><u>CHAPTER 9 REVISION HISTORY.....</u></b>	<b><u>30</u></b>
<b><u>9. Introduction to the chapter.....</u></b>	<b><u>30</u></b>
<b><u>9.1 Document revision.....</u></b>	<b><u>30</u></b>
<b><u>9.2 Web page of your device.....</u></b>	<b><u>31</u></b>
<b><u>9.3 Product support.....</u></b>	<b><u>32</u></b>

## CHAPTER 1 OVERVIEW

---

### 1. Introduction to the chapter

---

Thank you for choosing the STM32-P407 development board from Olimex! This document provides a User's Guide for the Olimex STM32-P407 development board. As an overview, this chapter gives the scope of this document and lists the board's features. The document's organization is then detailed.

The STM32-P407 development board enables code development of applications running on the M4 CORTEX STM32F407ZGT6 microcontroller, manufactured by STMicroelectronics.

### 1.1 Features

---

- STM32F407ZGT6 Cortex-M4 210DMIPS, 1MB Flash, 196KB RAM, 3×12-bit 2.4 MSPS A/D, 2×12-bit D/A converters, USB OTG HS and USB OTG FS, Ethernet, 14 timers, 3 SPI, 3 I2C, Ethernet, 2 CANs, 3 12 bit ADCs, 2 12 bit DACs, 114 GPIOs, Camera interface
- JTAG connector with ARM 2x10 pin layout for programming/debugging
- 512 KB fast external SRAM on board
- 4 Status LEDs
- Stereo Audio Codec CS4344
- CAN driver
- Temperature sensor
- Trimmer potentiometer
- Joystick for navigation
- 6610 LCD color 128x128 pixel TFT display
- SAMSUNG E700 VGA camera 640x480 color
- Tamper and Wakeup buttons
- 2 RS232 drivers and connectors
- 25 Mhz quartz crystal
- USB\_OTG
- USB\_HOST
- 100 Mbit Ethernet
- Mini SD/MMC card connector
- UEXT connector
- Power Jack
- RESET button and circuit
- Power-on led
- 3V battery connector
- Extension port connectors for many of microcontrollers pins
- PCB: FR-4, 1.5 mm (0,062"), soldermask, silkscreen component print

- Dimensions: 160x116 mm (6.3x4.6")

## **1.2 Organization**

---

Each section in this document covers a separate topic, organized as follow:

- Chapter 1 is an overview of the board usage and features
- Chapter 2 provides a guide for quickly setting up the board
- Chapter 3 contains the general board diagram and layout
- Chapter 4 describes the component that is the heart of the board: the STM32F407ZGT6 microcontroller
- Chapter 5 is an explanation of the control circuitry associated with the microcontroller to reset. Also shows the clocks on the board
- Chapter 6 covers the connector pinout, peripherals and jumper description
- Chapter 7 shows the memory map
- Chapter 8 provides the schematics
- Chapter 9 contains the revision history

---

## CHAPTER 2 SETTING UP THE STM32-P407 BOARD

---

### 2. Introduction to the chapter

---

This section helps you set up the STM32-P407 development board for the first time.

Please consider first the electrostatic warning to avoid damaging the board, then discover the hardware and software required to operate the board.

The procedure to power up the board is given, and a description of the default board behavior is detailed.

#### 2.1 Electrostatic warning

---

STM32-P407 is shipped in a protective anti-static package. The board must not be exposed to high electrostatic potentials. A grounding strap or similar protective device should be worn when handling the board. Avoid touching the component pins or any other metallic element.

#### 2.2 Requirements

---

In order to set up the STM32-P407, the following items are required:

- 5 Vdc power supply (or JTAG or SWD, or 5V TRACE, or 5V CAN, or 5V\_USB, depending on PWR\_SEL jumper position)
- SWD interface programmer

Note 1: additionally, the board can be programmed via JTAG interface but there are signals multiplexed with the LCD and the audio, so if using JTAG interface for programming you might need to implement a software mechanism to stop them or you might not be able to reprogram again.

Note 2: the board can also be programmed via the USART (RS232\_1) connector using the built-it bootloader application (without the need of third-party tool). This way of programming/debugging is slow but may provide a better/cheaper solution in certain cases. The configuration is explained in the RS232 chapter (6.10) of the manual.

You may use a pair of the following devices for this purpose:

- ARM-JTAG-COOCOX programmer/debugger which has both JTAG and SWD interfaces and works natively with CooCox IDE, and Keil uVision and IAR EW via plugin
- Any of Olimex's ARM-JTAG programmer/debugger (keeping in mind the note above)
- Any of Olimex's ARM-JTAG programmer/debugger + ARM-JTAG-SWD + Rowley CrossWorks

Also, a host-based software toolchain is required in order to program/debug the STM32-P407 board. There are also a number of ready IDEs available like CooCox IDE, IAR Embedded

Workbench, Rowley CrossWorks, etc.

Olimex distributes a free IDE that works with our OpenOCD programmers:

<https://www.olimex.com/Products/ARM/JTAG/resources/OpenOCD/>.

At the moment of writing this guide our ARM programmers/debuggers equipped with an ARM-JTAG-SWD work fine (out-of-the-box) with Rowley CrossWorks.

## 2.3 Powering the board

---

Provide +5 V DC to the board's power jack, OR +5 V via the JTAG or TRACE connector (before providing the power set the PWR\_SEL jumper in the correct position)

Additionally the board can be powered using the PROTO AREA pads. Provide 5V to the respective pad with the same label. Ground pad is named AGND.

On powering the board the PWR LED, the SATA4 LED and the display should turn on. The SATA1, SATA2 and SATA3 LEDs must start blinking consecutively.

If measuring the current consumption it should be around 30 mA.

## 2.4 Prebuilt software

---

On arrival the board has a basic demo installed which features test of the LEDs, the LCD, the joystick, the camera.

Note that the demo provided by Olimex LTD is the same as the demo provided for STM32-P207 though not optimized for the F407 processor.

**IMPORTANT:** If you have only a programmer with JTAG interface and you need to turn off the peripherals using the JTAG signals press WKUP button (if there is a reset after programming you might need to keep it pressed)! Pressing WKUP button will turn off those modules and will allow JTAG reprogramming. T



# CHAPTER 3 STM32-P407 BOARD DESCRIPTION

## 3. Introduction to the chapter

Here you get acquainted with the main parts of the board. Note the names used on the board differ from the names used to describe them. For the actual names check the STM32-P407 board itself.

### 3.1 Layout (top view)

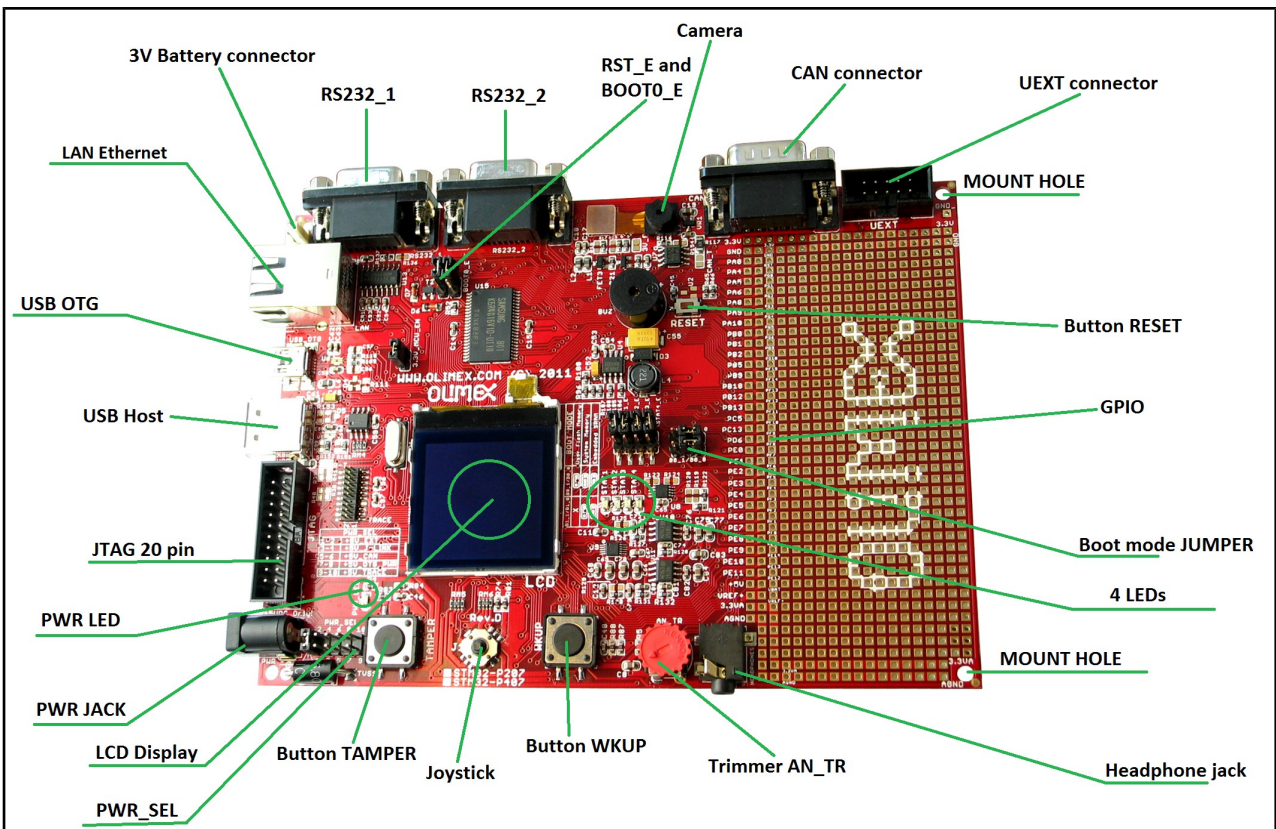

### 3.2 Layout (bottom view)

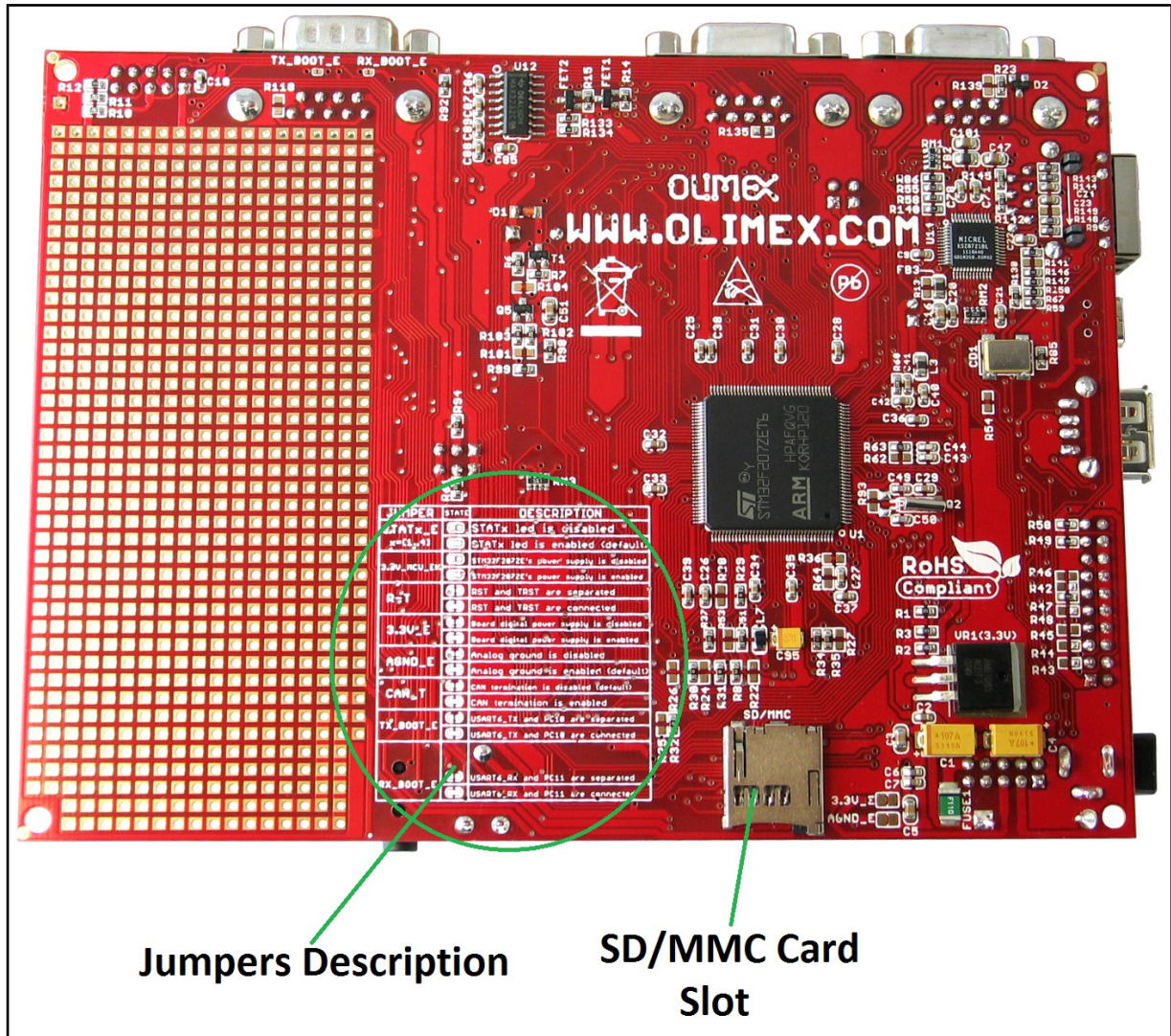

---

## CHAPTER 4 THE STM32F407ZGT6 MICROCONTROLLER

---

### 4. Introduction to the chapter

---

In this chapter is located the information about the heart of STM32-P407 – its microcontroller. The information is a modified version of the datasheet provided by its manufacturers.

#### 4.1 The microcontroller

---

- Core: ARM 32-bit Cortex™-M4 CPU with FPU, Adaptive real-time accelerator (ART Accelerator™) allowing 0-wait state execution from Flash memory, frequency up to 168 MHz, memory protection unit, 210 DMIPS/1.25 DMIPS/MHz (Dhrystone 2.1), and DSP instructions
- Memories
  - 1 Mbyte of Flash memory
  - 192+4 Kbytes of SRAM including 64-Kbyte of CCM (core coupled memory) data RAM
  - Flexible static memory controller supporting Compact Flash, SRAM, PSRAM, NOR and NAND memories
- LCD parallel interface, 8080/6800 modes
- Clock, reset and supply management
  - 1.8 V to 3.6 V application supply and I/Os
  - POR, PDR, PVD and BOR
  - 4-to-26 MHz crystal oscillator
  - Internal 16 MHz factory-trimmed RC (1% accuracy)
  - 32 kHz oscillator for RTC with calibration
  - Internal 32 kHz RC with calibration
  - Sleep, Stop and Standby modes
  - VBATsupply for RTC, 20×32 bit backup registers + optional 4 KB backup SRAM
- 3×12-bit, 2.4 MSPS A/D converters: 24 channels and 7.2 MSPS in triple interleaved mode
- 2×12-bit D/A converters
- General-purpose DMA: 16-stream DMA controller with FIFOs and burst support
- Up to 17 timers: up to twelve 16-bit and two 32-bit timers up to 168 MHz, each with up to 4 IC/OC/PWM or pulse counter and quadrature (incremental) encoder input
- Debug mode
  - Serial wire debug (SWD) & JTAG interfaces
  - Cortex-M4 Embedded Trace Macrocell™
- Up to 114 I/O ports with interrupt capability
- Up to 15 communication interfaces
  - 3 × I2C interfaces (SMBus/PMBus)
  - 4 USARTs/2 UARTs (10.5 Mbit/s, ISO 7816 interface, LIN, IrDA, modem control)
  - 3 SPIs (37.5 Mbits/s), 2 with muxed full-duplex I2S to achieve audio class accuracy via internal audio PLL or external clock

- 2 × CAN interfaces (2.0B Active)
- SDIO interface
- Advanced connectivity
  - USB 2.0 full-speed device/host/OTG controller with on-chip PHY
  - USB 2.0 high-speed/full-speed device/host/OTG controller with dedicated DMA, on-chip full-speed PHY and ULPI
  - 10/100 Ethernet MAC with dedicated DMA: supports IEEE 1588v2 hardware, MII/RMII
- 8- to 14-bit parallel camera interface up to 54 Mbytes/s
- True random number generator
- CRC calculation unit
- 96-bit unique ID
- RTC: subsecond accuracy, hardware calendar

For comprehensive information on the microcontroller visit the Microchip's web page for a datasheet.

At the moment of writing the microcontroller datasheet can be found at the following link:

[http://www.st.com/internet/com/TECHNICAL\\_RESOURCES/TECHNICAL\\_LITERATURE/DATASHEET/DM00037051.pdf](http://www.st.com/internet/com/TECHNICAL_RESOURCES/TECHNICAL_LITERATURE/DATASHEET/DM00037051.pdf)

If the Cortex M4 processor listed above seems like an overkill we have the same board offered with Cortex M3 one – STM32F207ZET6. The name of the board is STM32-P207. The table of comparison can be found below:

	STM32F207ZET6	STM32F407ZGT6
Maximum speed	120Mhz	168Mhz
Program memory	512KB	1024KB
Ram memory	132KB	192KB

## CHAPTER 5 CONTROL CIRCUITY

---

### 5. Introduction to the chapter

---

Here you can find information about reset circuit and quartz crystal locations.

#### 5.1 Reset

---

STM32-P407 reset circuit includes R65 (10 K $\Omega$ ), R66(560  $\Omega$ ), C45(100 nF), STM32F407ZGT6 pin 25 (NRST) and a RESET button. The RESET is also connected to the proto area.

#### 5.2 Clock

---

25 MHz quartz crystal Q1 is connected to pins 23 and 24 of the processor.

Real time clock (RTC) Q2 is found at pins 8 and 9 of the processor.

## CHAPTER 6 HARDWARE

### 6. Introduction to the chapter

In this chapter are presented the connectors that can be found on the board all together with their pinout. Proto area is shown. Jumpers functions are described. Notes and info on specific peripherals are presented. Notes regarding the interfaces are given.

#### 6.1 JTAG connector

The 20-pin JTAG connector provides the interface for JTAG or/and SWD/TRACE programming/debugging. It is advisable to use SWD or TRACE interface programmers.

\*The JTAG TRST signal is multiplexed with the display. When using JTAG interface you will not be able to debug the display of the board. If you wish to program the board with JTAG make sure to hold the WKUP button when programming/debugging until you wipe the system memory or the JTAG will not connect. This behavior is caused by the initial demo which redefines the pin to show the display.

Another workaround is to set the bootloader jumpers so the board would attempt to boot from the Embedded SRAM (and since it is blank, the display would not start which will allow you to debug with the JTAG). Note this is not an issue if you use SWD interface.

JTAG/SWD interface			
Pin #	Signal Name	Pin #	Signal Name
1	+3.3V	11	+3.3 V
2	+3.3V	12	GND
3	TRST/SPI1_MISO*	13	TD0/I2S3_CK
4	GND	14	GND
5	PGCTDI/I2S3_WS	15	RST
6	GND	16	GND
7	TMS	17	+5V_J-LINK
8	GND	18	GND
9	TCK	19	+5V_J-LINK
10	GND	20	GND

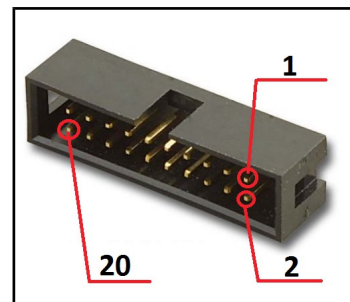

TRACE interface			
Pin #	Signal Name	Pin #	Signal Name
1	+3.3V	11	+5V_TRACE
2	TMS	12	TEMP_ALERT
3	GND	13	+5V_TRACE
4	TCK	14	USB_HS_VBUSON
5	GND	15	GND
6	TDO/I2S3_CK	16	DCMI_D4
7	Not connected	17	GND
8	TDI/I2S3_WS	18	DCMI_D6
9	GND	19	GND
10	RST	20	DCMI_D7

## 6.2 UEXT

STM32-P407 board has UEXT connector and can interface Olimex's UEXT modules.

For more information on UEXT please visit:

<https://www.olimex.com/Products/Modules/UEXT/>

Pin #	Signal Name
1	+3.3V
2	GND
3	DCMI_D0/USART6_TX
4	USART6_RX
5	SOFTWARE_SCL
6	SOFTWARE_SDA
7	SD_D3/USART3_RX/SPI3_MISO
8	SD_CLK/SPI3_MOSI
9	SD_D2/USART3_TX/SPI3_SCK
10	STAT3/CS_UEXT

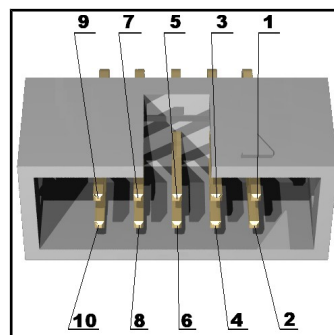

### 6.3 Pads on the proto area

For your convenience the pads are named individually near each of them. Please take extra care about the numbering but consider that there might be offset.

PAD #	Signal Name	PAD#	Signal Name
PA0	BUT WKUP	RST	RST
PA4	DCMI_HSYNC	PG0	A10
PA5	SPI1_SCK	PG1	A11
PA6	DCMI_PIXCLK	PG2	A12
PA8	MCO1	PG3	A13
PA9	OTG_FS_VBUS	PG4	A14
PA10	DCMI_D1	PG5	A15
PB0	LCD_BL	PG6	RIGHT(JOYSTICK)
PB1	BUZ	PG9	USART6_RX
PB2	CAM_ENB	PG10	SOFT_SCL
PB5	I2S3_SD	PF15	A9
PB9	CAN1_TX	PF14	A8
PB10	USB_FS_FAULT	PF13	A7
PB12	OTG_HS_ID	PF12	A6
PB13	OTG_HS_VBUS	PF11	CAM_RST

PAD #	Signal Name	PAD#	Signal Name
PC5	ETH_RMII_RXD1	PF10	ETH_RXER
PC13	BUT TAMPER	PF9	SSTAT4/CAM_PWR
PD6	LCD_CS	PF8	STAT3/CS_UEXT
PE0	/BLE	PF7	STAT2/CAN_CTRL
PE1	/BHE	PF6	STAT1
PE2	TEMP_ALERT	PF5	A5
PE3	USB_HS_VBUSON	PF4	A4
PE4	DCMI_D4	PF3	A3
PE5	DCMI_D6	PF2	A2
PE6	DCMI_D7	PF1	A1
PE7	D4	PF0	A0
PE8	D5	PE15	D12

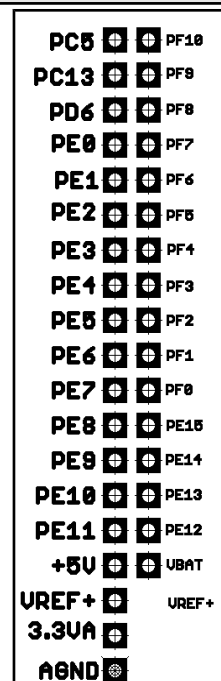
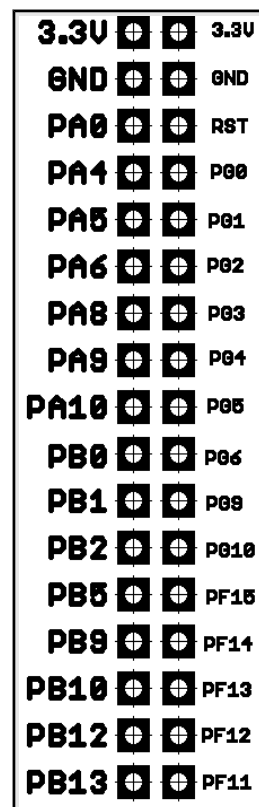



PAD #	Signal Name	PAD#	Signal Name
PE9	D6	PE14	D11
PE10	D7	PE13	D10
PE11	D8	PE12	D9
+5V	+5V DC	VBAT	VBAT

## 6.4 USB\_OTG

Pin #	Signal Name
1	+5V
2	D-
3	D+
4	OTG_HS_ID
5	GND

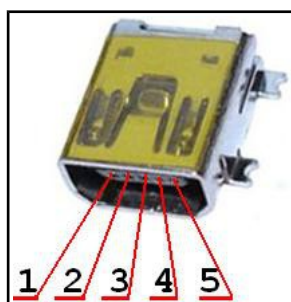

## 6.5 USB HOST

PIN#	SIGNAL NAME
1	+5 V
2	USB_HOST_D-
3	USB_HOST_D+
4	GND

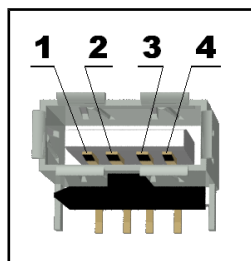

## 6.6 LAN connector

PIN#	SIGNAL NAME
1	TX+
2	TX-
3	VDD
4	NOT CONNECTED
5	NOT CONNECTED
6	VDD
7	RX+
8	RX-

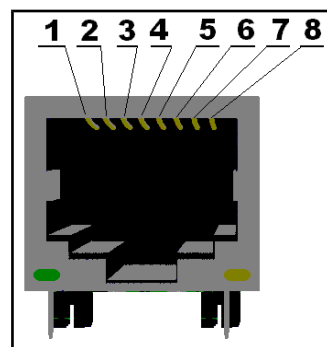

LED	Color	Usage
Right	Green	Link status
Left	Yellow	Activity status

### 6.7 PWR Jack

Pin #	Signal Name
1	Power Input
2	GND

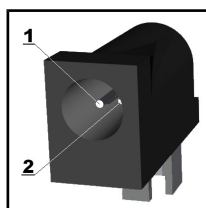

### 6.8 Headphones connector

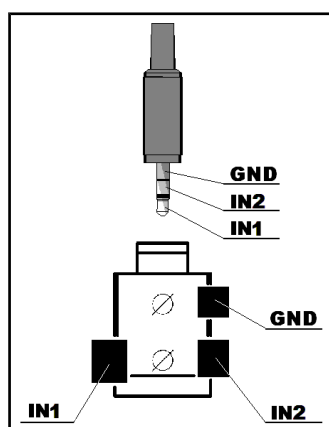

### 6.9 SD/MMC slot

Pin #	Signal Name
1	DAT2
2	DAT3/CS
3	CMD/DI
4	VDD
5	CLK/SCLK

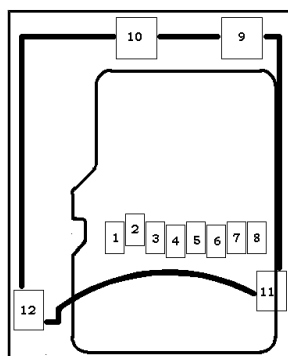

6	VSS
7	DAT0/DO
8	DAT1

## 6.10 RS232\_1

RS232\_1 is located on USART6/SPI3 line. This interface can be used for accessing the built-in bootloader of STM32F407 microcontroller. You will need DB9 male – DB9 female RS232 cable. You will also need a freely distributed piece of software called “Flash Loader Demo” - it can be downloaded from the official page of the microcontroller under the “Design resources” (by the time of writing the resource is located here: <http://www.st.com/web/en/catalog/tools/PF257525> ). Once you have acquired the needed perquisites we need to set the board for bootloader mode as explained below:

Step 0. It is good idea to revert all jumpers to default positions in the beginning

Step 1. Change jumper B0\_1/B0\_0 to B0\_1 position (as said in the table print – “Boot Mode: System Memory”)

Step 2. RST\_E and BOOT0\_E should be open, as per default (if they are closed; they are located below the RS232 connectors)

Step 3. Close TX\_BOOT\_E and RX\_BOOT\_E by soldering. They are located on the back of the board near CAN connector.

Step 4. Download, install the Flash Loader Demo (from the STM32F407 web page, resources window)

Step 5. Connect RS232 and run the Flash Loader Application, the target is STM32F4\_1024K (check the screenshots below).

Pin #	Signal Name
1	Not Connected
2	T1OUT
3	R1IN
4	Not Connected
5	GND
6	Not Connected
7	CTS
8	RTS
9	Not Connected

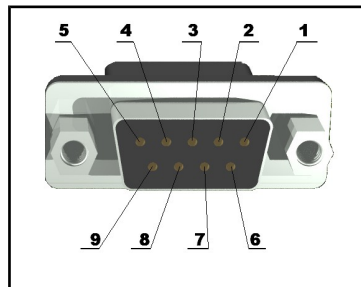

### 6.11 RS232\_2

RS232\_2 is located on USART3 (processor pins D13 – D14, A17 – A16)

Pin #	Signal Name
1	Not connected
2	T1OUT
3	R1IN
4	Not connected
5	GND
6	Not connected
7	CTS
8	RTS
9	Not connected

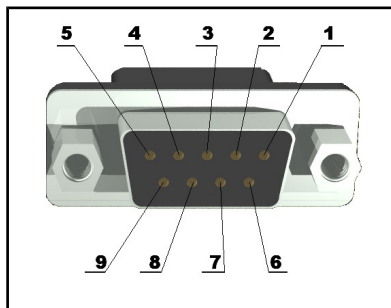

### 6.12 CAN connector

Pin#	Signal name
1	Not connected
2	CANL
3	VSS
4	Not connected
5	VSS
6	GND
7	CANH
8	Not connected
9	+5V_CAN

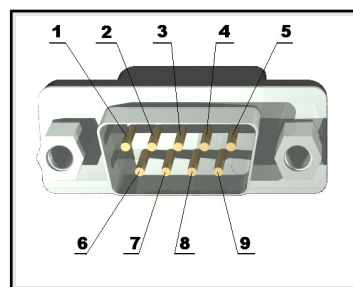

### 6.13 Battery connector

Pin #	Signal Name
1	VBAT
2	GND

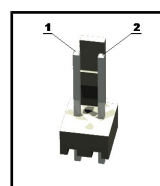

## 6.14 Jumper description

---

Most of the jumper configurations are printed with white print on the PCB for your convenience.

### PWR\_SEL

---

This jumper control the way the board is powered. There is a table printed on the board with the positions. You can check the table below also. Position 1-2 is the one at the PWR connector side.

PWR_SEL	
1 - 2	+5V_EXT
3 - 4	+5V_J-LINK
5 - 6	+5V_CAN
7 - 8	+5V_USB_OTG
9 - 10	+5V_TRACE

**Default position is 3-4.**

### STAT1\_E, STAT2\_E, STAT3\_E, STAT4\_E

---

Those 4 jumpers control whether the LEDs are powered(closed) or not(open).

**Default state is closed.** 

### BOOT0\_E

---

Connected to pin 138 (BOOT0/VPP), enables boot when open.

**Default state is open.** 

### RST\_E

---

Controls the RST on the RS232\_1. If closed is present. Default state is not present.

**Default state is open.** 

### B1\_1/B1\_0, B0\_1/B0\_0

---

These jumpers should be moved together and control which memory would be used to load code initially. There is a table on the board describing the postions.

**Default states of both jumpers are B1\_0, B0\_0.** 

---

### 3.3V\_MCU\_EN

---

When closed enables the power supply on the STM32F207ZET.

**Default state is closed.**



---

### TX\_BOOT\_E

---

If closed separates USART6\_TX and PC10.

**Default state is open.**



---

### RX\_BOOT\_E

---

If closed separates USART6\_RX and PC11.

**Default state is open.**



---

### 3.3V\_E

---

Board's digital power supply is disabled if open.  
Enabled if closed.

**Default state is open.**



---

### AGND\_E

---

Analog GND is disabled if open.  
If closed Analog GND is enabled.

**Default state is closed.**



---

### R-T

---

RST and TRST are separated if open.  
RST and TRST are connected if closed.  
Refer to the schematic near the JTAG connector for how this jumper influences the JTAG programming of the board.

**Default state is open.**



---

### CAN\_T

---

Can termination is disabled if open.

**Default state is open.**



## 6.15 LCD Display with backlight

---

replica of Nokia 6610 color display 128x128 pixels

## 6.16 VGA Color Camera

---

640x480 pixels (0.3 mega pixel) Samsung 700 camera + connector

## 6.17 Additional hardware components

---

The components below are mounted on STM32-P407 but are not discussed above. They are listed here for completeness:

Joystick

Temperature sensor

Audio out

Trimmer

Buzzer

Additional memory

2 buttons + RST button

4 status LEDs + PWR LED

## 6.18 Notes on interfaces

---

Note that due the evaluation nature of the board not all interfaces are immediately available on the proto area. Some of the signals are used by peripherals and other devices.

One of those interfaces were the 3 x I2C which were sacrificed for additional peripherals and signals that are hard to implement on software level.

There are ways, of course. Depends on which interface you are willing to let go. I will list the options in the following order (I2C number - processor pin - signal - interface affected):

I2C1\_SCL - 139 - CAN1\_RX - CAN interface

I2C1\_SDA - 140 - CAN1\_TX - CAN interface

I2C2\_SCL - 11 - A0 - the additional memory

I2C2\_SDA - 10 - A1 - the additional memory

I2C3\_SCL - 100 - MCO1 - camera interface

I2C3\_SDA - 99 - SD\_D1/DCMI\_DB - SD card / camera

To my mind, the best idea would be to disable the CAN interface.

When you have chosen the preferred I2C port you need to decide whether to remove the peripheral it is connected to or to disable it by software means (instead of removing components just always set the needed signals as outputs – disable input and connect additional wires). The final thing to do is to use 2.2k pull-up resistors on the lines you have chosen (for instance I2C1\_SCL and I2C1\_SDA) - I2C requires pull-ups.



## **CHAPTER 7 MEMORY**

---

### **7. Introduction to the chapter**

---

On the next page you can find a memory map for this family of processors. It is strongly recommended to refer to the original datasheet released by STMicroelectronics for one of higher quality.



## CHAPTER 8 SCHEMATICS

---

### 8. Introduction to the chapter

---

In this chapter are located the schematics describing logically and physically STM32-P407.

#### 8.1 Eagle schematic

---

STM32-P407 schematic is visible for reference here. You can also find them on the web page for STM32-P407 at our site: <https://www.olimex.com/Products/ARM/ST/STM32-P407/>. They are located in HARDWARE section.

The EAGLE schematic is situated on the next page for quicker reference.

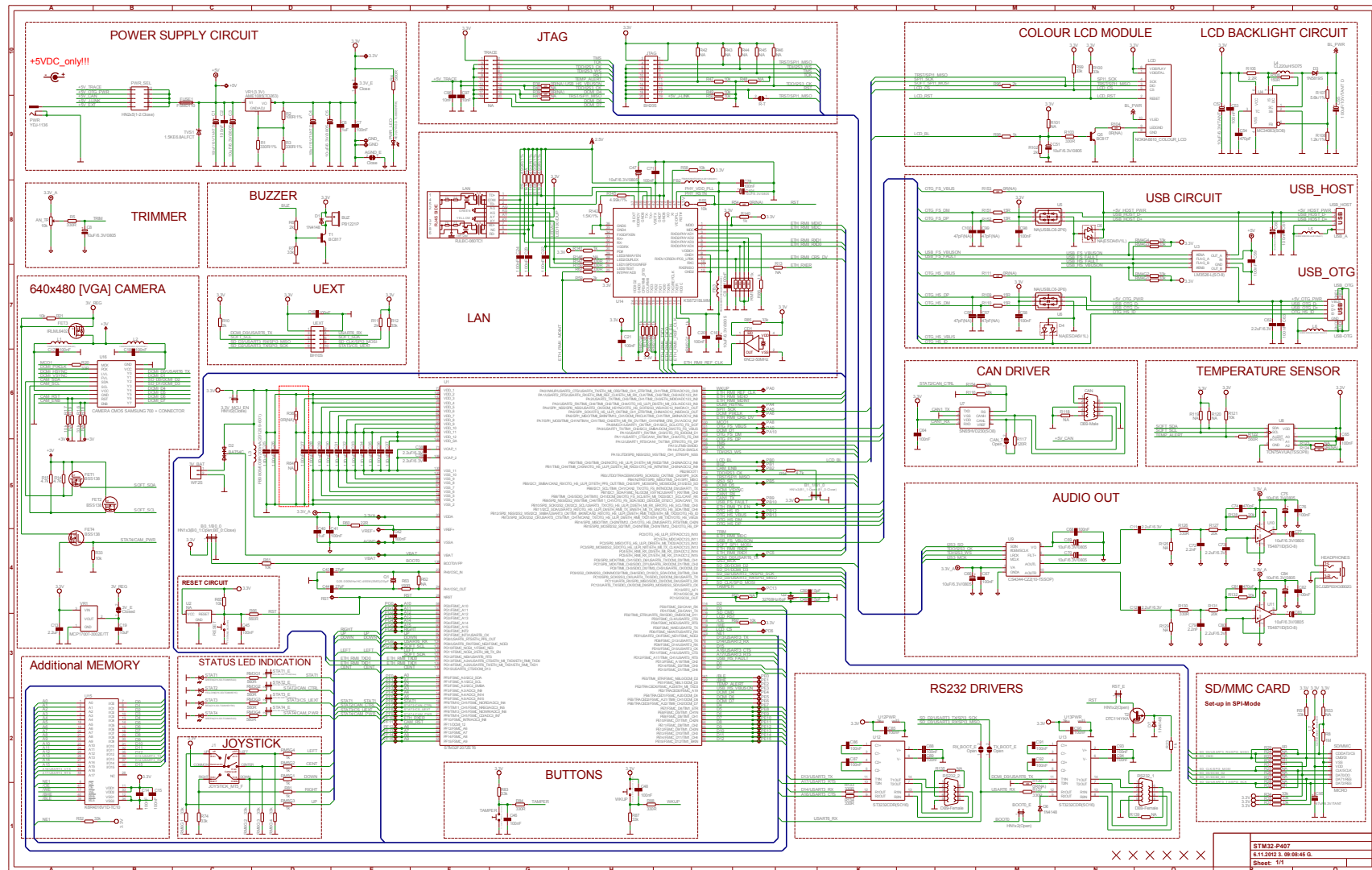

## 8.2 Physical dimensions

Note that all dimensions are in inches.

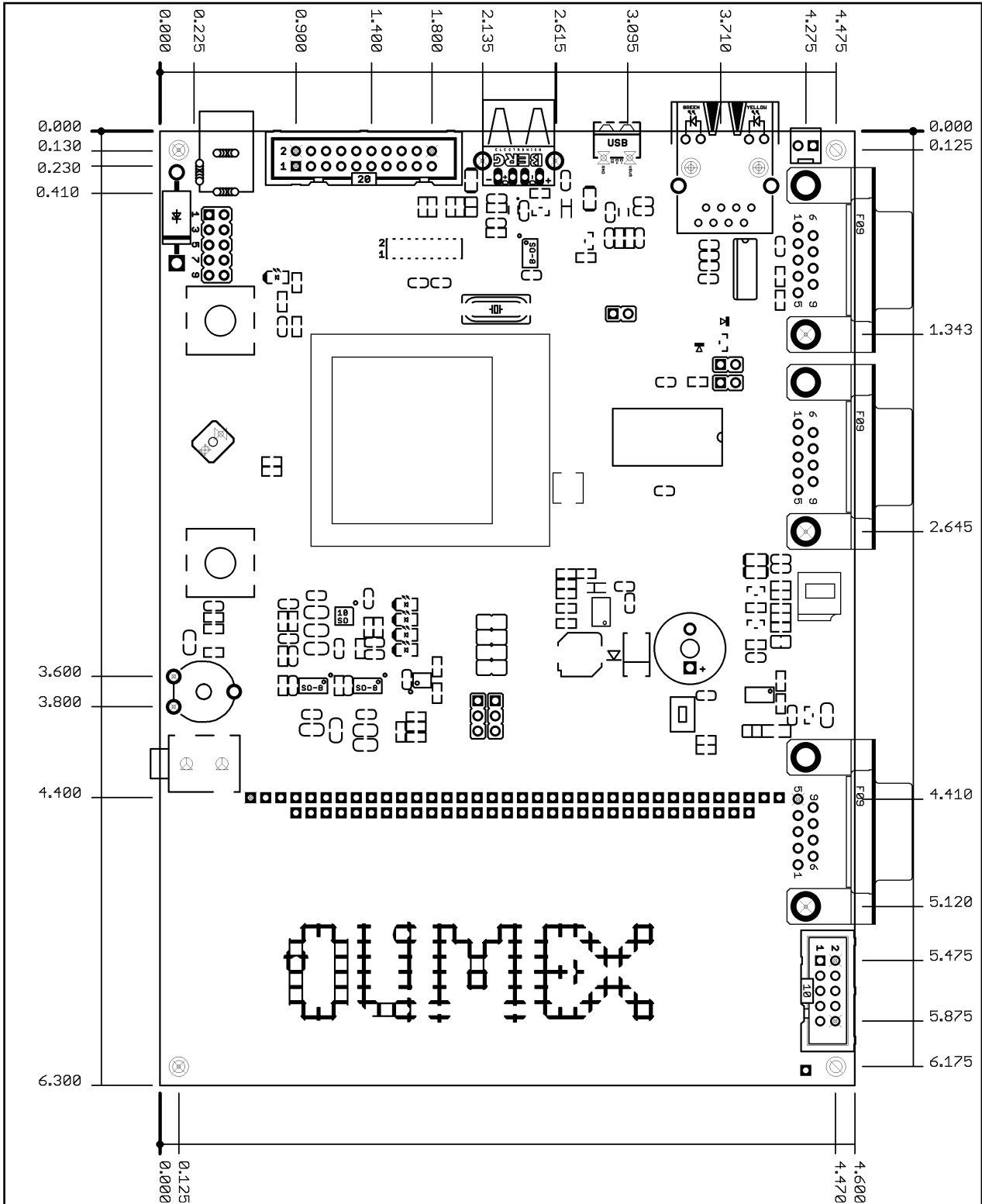

## CHAPTER 9 REVISION HISTORY

---

### 9. Introduction to the chapter

---

In this chapter you will find the current and the previous version of the document you are reading. Also the web-page for your device is listed. Be sure to check it after a purchase for the latest available updates and examples.

### 9.1 Document revision

---

Revision	Changes	Modified Pages
A	Initial Creation	All
B	<p>Additional information about the JTAG interface;</p> <p>Additional information about the I2C availability</p> <p>ARM-JTAG-COOCOX added to compatible programmers</p> <p>Added better disclaimer and added product support page</p> <p>Changed links with proper ones</p> <p>Overall change of the design of the document</p>	All
C	Added information how to enter bootloader mode	7, 19, 20
D	Fixed improper jumper position suggested to enter bootloader mode: RST_E and BOOT0_E should be open to be able to download a program via the bootloader application	7, 19, 20

## 9.2 Web page of your device

---

The web page you may visit for more info on your device is <https://www.olimex.com/Products/ARM/ST/STM32-P407/>.

### ORDER CODES:

**STM32-P407** – completely assembled and tested

**ARM-JTAG-COOCOX** – ARM debugger with JTAG and SWD interfaces

**USB-MINI-CABLE** – USB mini to USB-A cable

**ARM-USB-TINY** – for custom programming/debugging

**ARM-USB-TINY-H** – for custom programming/debugging

**ARM-JTAG-SWD** – SWD adapter for our ARM-JTAG programmers

How to order?

You can order directly from our web-shop or from any of our distributors. For the list of distributors visit: <https://www.olimex.com/Distributors/>

**Check our webpage <https://www.olimex.com/> for more info.**

## 9.3 Product support

---

For product support, hardware information and error reports mail to: [support@olimex.com](mailto:support@olimex.com). Note that we are primarily a hardware company and our software support is limited.

Please consider reading the paragraph below about the warranty of Olimex products.

### Warranty and returns:

Our boards have lifetime warranty against manufacturing defects and components.

During development work it is not unlikely that you can burn your programmer or development board. This is normal, we also do development work and we have damaged A LOT of programmers and boards during our daily job so we know how it works. If our board/programmer has worked fine then stopped, please check if you didn't apply over voltage by mistake, or shorted something in your target board where the programmer was connected etc. Sometimes boards might get damaged by ESD shock voltage or if you spill coffee on them during your work when they are powered.

Please note that warranty do not cover problems caused by improper use, shorts, over-voltages, ESD shock etc.

**If the board has warranty label it should be not broken. Broken labels void the warranty, same applies for boards modified by the customer, for instance soldering additional components or removing components - such boards will be not be a subject of our warranty.**

If you are positive that the problem is due to manufacturing defect or component you can return the board back to us for inspection.

When we receive the board we will check and if the problem is caused due to our fault and we will repair/replace the faulty hardware free of charge, otherwise we can quote price of the repair.

Note that all shipping expenses back and forth have to be covered by the customer. Before you ship anything back you need to ask for RMA. When you ship back please attach to it your shipping address, phone, e-mail, RMA# and brief description of the problem. All boards should be sent back in antistatic package and well packed to prevent damages during the transport.