

NJL4281D (NPN) NJL4302D (PNP)

Complementary ThermalTrak™ Transistors

The ThermalTrak family of devices has been designed to eliminate thermal equilibrium lag time and bias trimming in audio amplifier applications. They can also be used in other applications as transistor die protection devices.

Features

- Thermally Matched Bias Diode
- Instant Thermal Bias Tracking
- Absolute Thermal Integrity
- High Safe Operating Area
- Pb-Free Packages are Available*

Benefits

- Eliminates Thermal Equilibrium Lag Time and Bias Trimming
- Superior Sound Quality Through Improved Dynamic Temperature Response
- Significantly Improved Bias Stability
- Simplified Assembly
 - ◆ Reduced Labor Costs
 - ◆ Reduced Component Count
- High Reliability

Applications

- High-End Consumer Audio Products
 - ◆ Home Amplifiers
 - ◆ Home Receivers
- Professional Audio Amplifiers
 - ◆ Theater and Stadium Sound Systems
 - ◆ Public Address Systems (PAs)



ON Semiconductor®

<http://onsemi.com>

**BIPOLAR POWER
TRANSISTORS**
15 AMP, 350 VOLT, 230 WATT

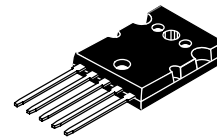

TO-264, 5 LEAD
CASE 340AA
STYLE 1

MARKING DIAGRAM

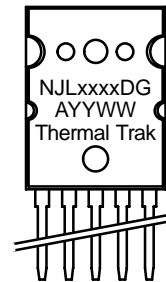

SCHEMATIC

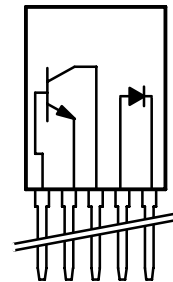

NJLxxxxD = Device Code
xxxx = 4281 or 4302
G = Pb-Free Package
A = Assembly Location
YY = Year
WW = Work Week

ORDERING INFORMATION

Device	Package	Shipping
NJL4281D	TO-264	25 Units / Rail
NJL4281DG	TO-264 (Pb-Free)	25 Units / Rail
NJL4302D	TO-264	25 Units / Rail
NJL4302DG	TO-264 (Pb-Free)	25 Units / Rail

*For additional information on our Pb-Free strategy and soldering details, please download the ON Semiconductor Soldering and Mounting Techniques Reference Manual, SOLDERRM/D.

NJL4281D (NPN) NJL4302D (PNP)

MAXIMUM RATINGS (T_J = 25°C unless otherwise noted)

Rating	Symbol	Value	Unit
Collector–Emitter Voltage	V _{CEO}	350	Vdc
Collector–Base Voltage	V _{CBO}	350	Vdc
Emitter–Base Voltage	V _{EBO}	5	Vdc
Collector–Emitter Voltage – 1.5 V	V _{CEX}	350	Vdc
Collector Current – Continuous – Peak (Note 1)	I _C	15 30	Adc
Base Current – Continuous	I _B	1.5	Adc
Total Power Dissipation @ T _C = 25°C Derate Above 25°C	P _D	230 1.84	W W/°C
Operating and Storage Junction Temperature Range	T _J , T _{stg}	– 65 to +150	°C
DC Blocking Voltage	V _R	200	V
Average Rectified Forward Current	I _{F(AV)}	1.0	A

THERMAL CHARACTERISTICS

Characteristic	Symbol	Max	Unit
Thermal Resistance, Junction–to–Case	R _{θJC}	0.54	°C/W

Stresses exceeding Maximum Ratings may damage the device. Maximum Ratings are stress ratings only. Functional operation above the Recommended Operating Conditions is not implied. Extended exposure to stresses above the Recommended Operating Conditions may affect device reliability.

1. Pulse Test: Pulse Width = 5 ms, Duty Cycle < 10%.

ATTRIBUTES

Characteristic	Value
ESD Protection Human Body Model Machine Model	>8000 V > 400 V
Flammability Rating	UL 94 V–0 @ 0.125 in

NJL4281D (NPN) NJL4302D (PNP)

ELECTRICAL CHARACTERISTICS (T_C = 25°C unless otherwise noted)

Characteristic	Symbol	Min	Max	Unit
OFF CHARACTERISTICS				
Collector Emitter Sustaining Voltage (I _C = 50 mA, I _B = 0)	V _{CE(sus)}	350	–	Vdc
Collector Cut-off Current (V _{CE} = 200 V, I _B = 0)	I _{CEO}	–	100	μAdc
Collector Cutoff Current (V _{CB} = 350 Vdc, I _E = 0)	I _{CBO}	–	50	μAdc
Emitter Cutoff Current (V _{EB} = 5.0 Vdc, I _C = 0)	I _{EBO}	–	5.0	μAdc
SECOND BREAKDOWN				
Second Breakdown Collector with Base Forward Biased (V _{CE} = 50 Vdc, t = 1.0 s (non-repetitive)) (V _{CE} = 100 Vdc, t = 1.0 s (non-repetitive))	I _{S/b}	4.5 1.0	– –	Adc
ON CHARACTERISTICS				
DC Current Gain (I _C = 100 mAdc, V _{CE} = 5.0 Vdc) (I _C = 1.0 Adc, V _{CE} = 5.0 Vdc) (I _C = 3.0 Adc, V _{CE} = 5.0 Vdc) (I _C = 5.0 Adc, V _{CE} = 5.0 Vdc) (I _C = 8.0 Adc, V _{CE} = 5.0 Vdc) (I _C = 15 Adc, V _{CE} = 5.0 Vdc)	h _{FE}	80 80 80 80 40 10	250 250 250 250 – –	–
Collector–Emitter Saturation Voltage (I _C = 8.0 Adc, I _B = 0.8 Adc)	V _{CE(sat)}	–	1.0	Vdc
Emitter–Base Saturation Voltage (I _C = 8.0 Adc, I _B = 0.8 A)	V _{BE(sat)}	–	1.4	Vdc
Base–Emitter ON Voltage (I _C = 8.0 Adc, V _{CE} = 5.0 Vdc)	V _{BE(on)}	–	1.5	Vdc
DYNAMIC CHARACTERISTICS				
Current–Gain – Bandwidth Product (I _C = 1.0 Adc, V _{CE} = 5.0 Vdc, f _{test} = 1.0 MHz)	f _T	35	–	MHz
Output Capacitance (V _{CB} = 10 Vdc, I _E = 0, f _{test} = 1.0 MHz)	C _{ob}	–	600	pF
Maximum Instantaneous Forward Voltage (Note 2) (i _F = 1.0 A, T _J = 25°C) (i _F = 1.0 A, T _J = 150°C)	V _F		1.1 0.93	V
Maximum Instantaneous Reverse Current (Note 2) (Rated dc Voltage, T _J = 25°C) (Rated dc Voltage, T _J = 150°C)	i _R		10 100	μA
Maximum Reverse Recovery Time (i _F = 1.0 A, di/dt = 50 A/μs)	t _{rr}		100	ns

2. Diode Pulse Test: Pulse Width = 300 μs, Duty Cycle ≤ 2.0%.

NJL4281D (NPN) NJL4302D (PNP)

TYPICAL CHARACTERISTICS

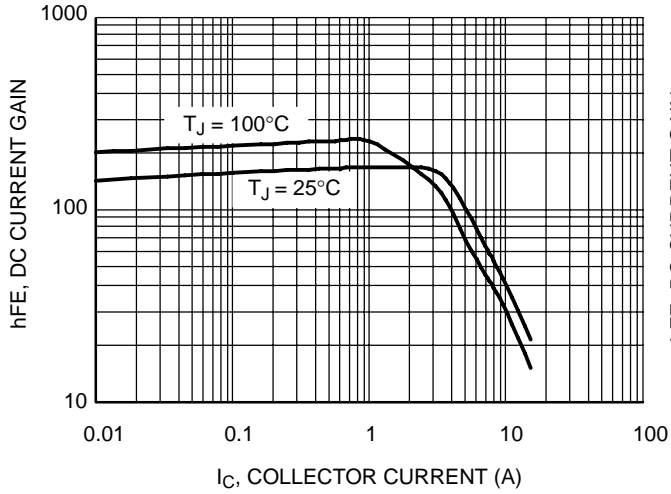

Figure 1. DC Current Gain, $V_{CE} = 5\text{ V}$, NPN NJL4281D

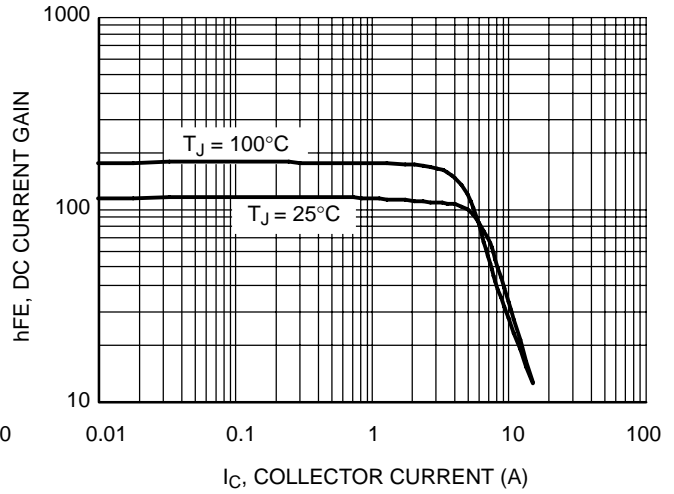

Figure 2. DC Current Gain, $V_{CE} = 5\text{ V}$, PNP NJL4302D

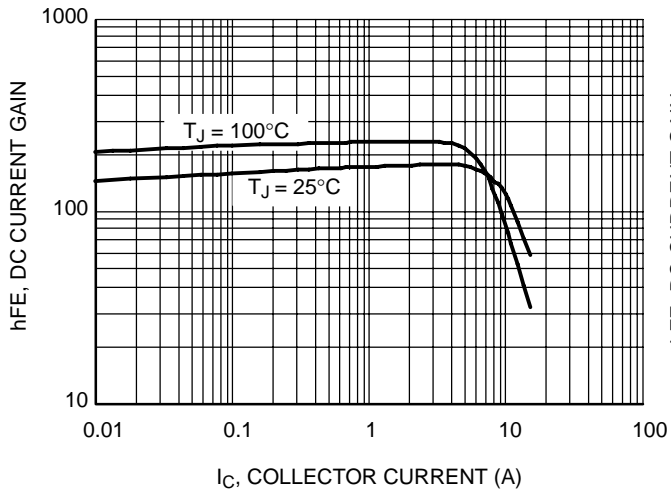

Figure 3. DC Current Gain, $V_{CE} = 20\text{ V}$, NPN NJL4281D

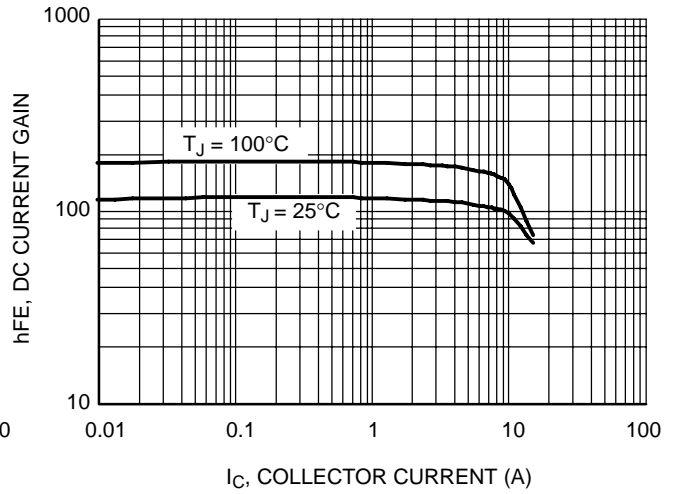

Figure 4. DC Current Gain, $V_{CE} = 20\text{ V}$, PNP NJL4302D

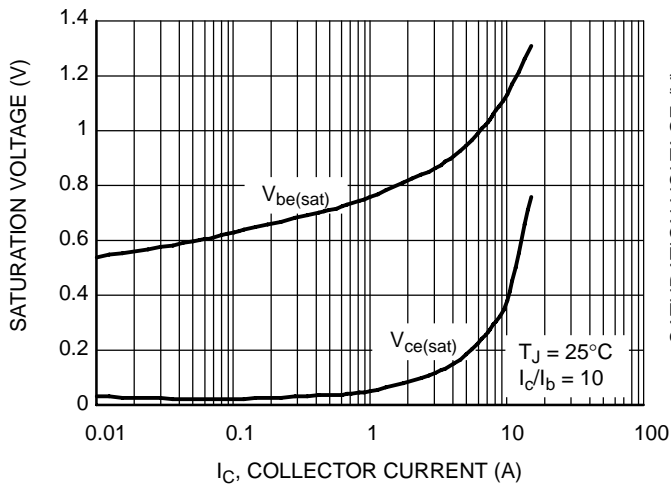

Figure 5. Typical Saturation Voltage, NPN NJL4281D

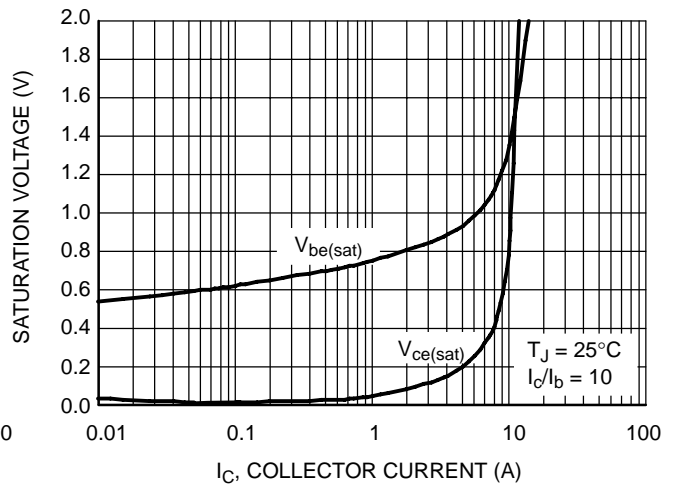

Figure 6. Typical Saturation Voltage, PNP NJL4302D

NJL4281D (NPN) NJL4302D (PNP)

TYPICAL CHARACTERISTICS

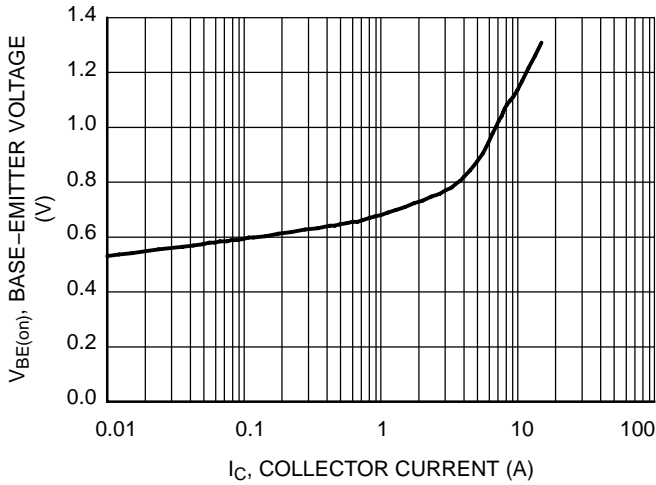

Figure 7. Typical Base-Emitter Voltages, NPN NJL4281D

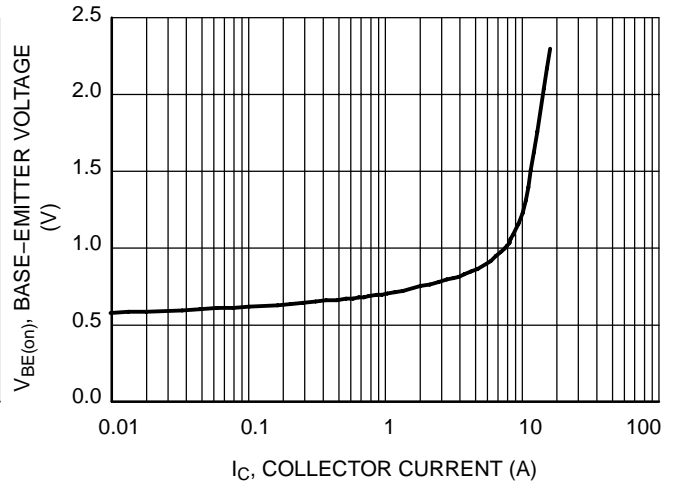

Figure 8. Typical Base-Emitter Voltages, PNP NJL4302D

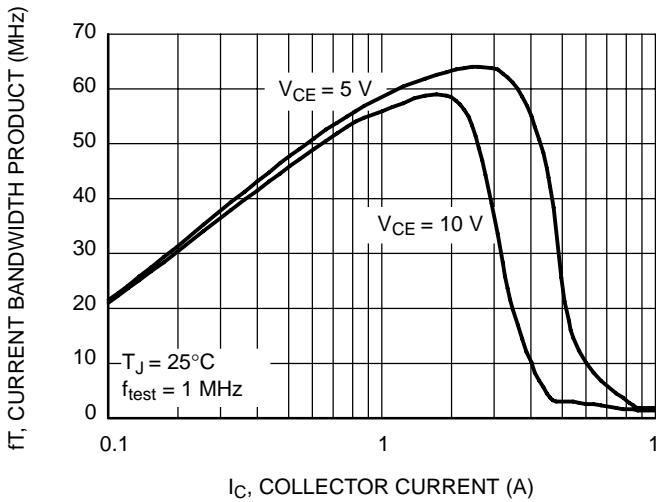

Figure 9. Typical Current Gain Bandwidth Product, NPN NJL4281D

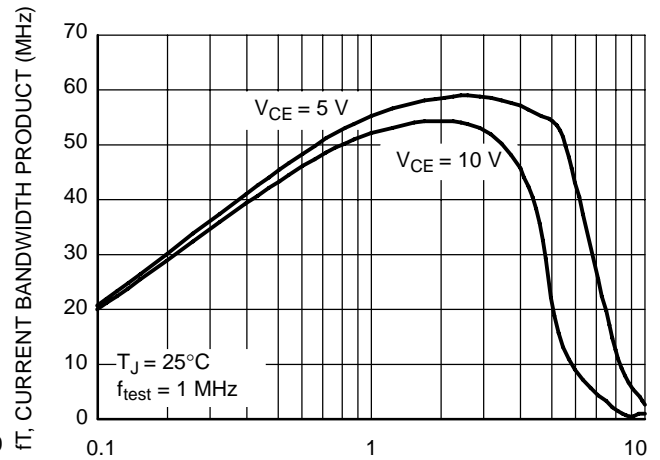

Figure 10. Typical Current Gain Bandwidth Product, PNP NJL4302D

NJL4281D (NPN) NJL4302D (PNP)

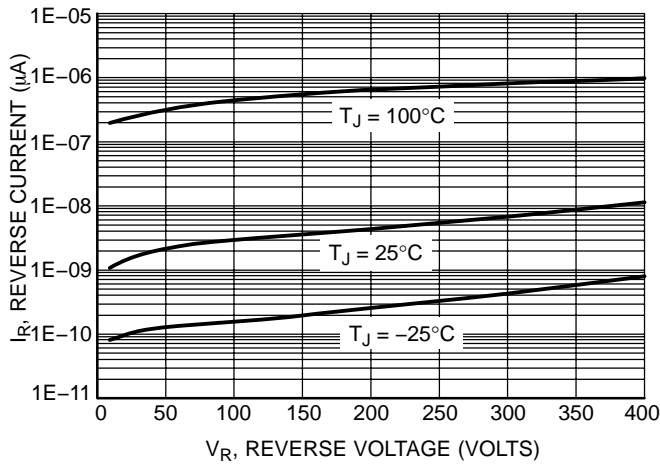

Figure 11. Typical Diode Reverse Current

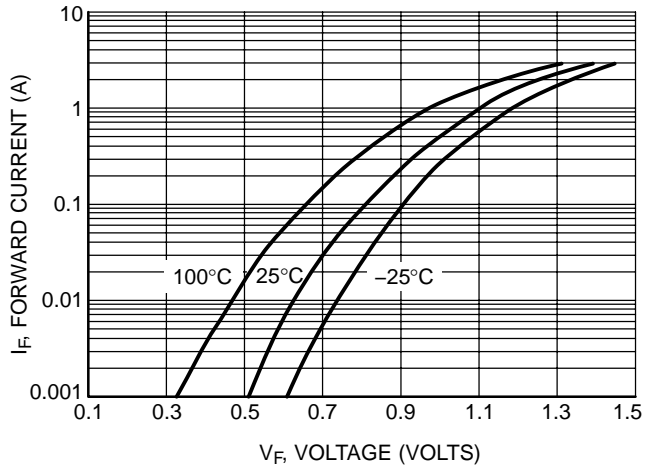

Figure 12. Typical Diode Forward Voltage

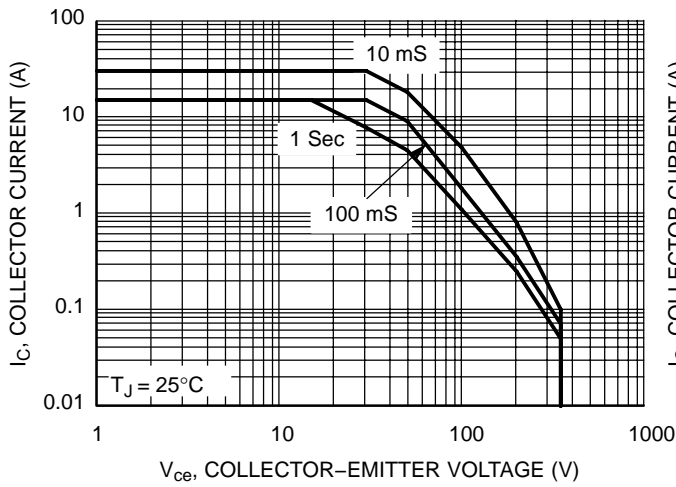

Figure 13. Active Region Safe Operating Area, NPN NJL4281D

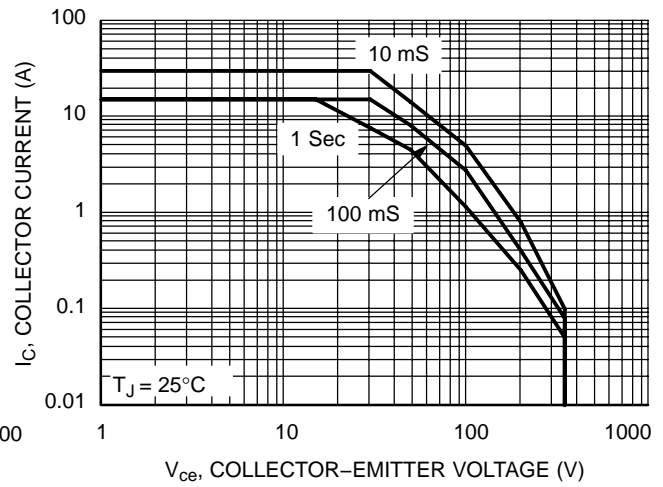
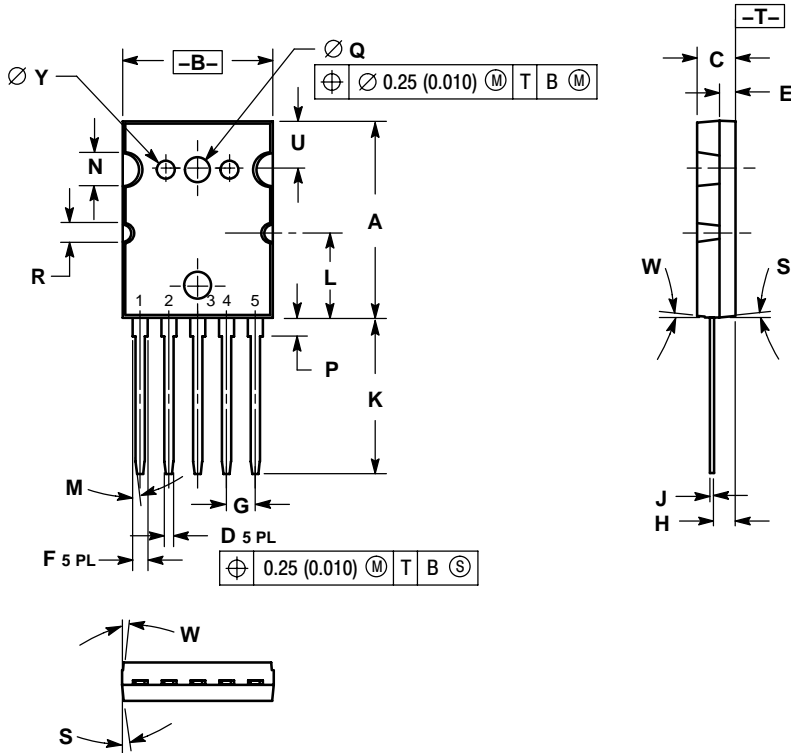

Figure 14. Active Region Safe Operating Area, PNP NJL4302D

NJL4281D (NPN) NJL4302D (PNP)

PACKAGE DIMENSIONS

TO-264, 5 LEAD
CASE 340AA-01
ISSUE O



NOTES:

1. DIMENSIONING AND TOLERANCING PER ANSI Y14.5M, 1982.
2. CONTROLLING DIMENSION: MILLIMETER.

DIM	MILLIMETERS			INCHES		
	MIN	NOM	MAX	MIN	NOM	MAX
A	25.857	25.984	26.111	1.018	1.023	1.028
B	19.761	19.888	20.015	0.778	0.783	0.788
C	4.928	5.055	5.182	0.194	0.199	0.204
D	1.219 BSC			0.0480 BSC		
E	2.032	2.108	2.184	0.0800	0.0830	0.0860
F	1.981 BSC			0.0780 BSC		
G	3.81 BSC			0.150 BSC		
H	2.667	2.718	2.769	0.1050	0.1070	0.1090
J	0.584 BSC			0.0230 BSC		
K	20.422	20.549	20.676	0.804	0.809	0.814
L	11.28 REF			0.444 REF		
M	0°	---	7°	0°	---	7°
N	4.57 REF			0.180 REF		
P	2.259	2.386	2.513	0.0889	0.0939	0.0989
Q	3.480 BSC			0.1370 BSC		
R	2.54 REF			0.100 REF		
S	0°	---	8°	0°	---	8°
U	6.17 REF			0.243 REF		
W	0°	---	6°	0°	---	6°
Y	2.388 BSC			0.0940 BSC		

STYLE 1:

1. BASE
2. EMITTER
3. COLLECTOR
4. ANODE
5. CATHODE

ThermalTrak is a trademark of Semiconductor Components Industries, LLC (SCILLC).

ON Semiconductor and **ON** are registered trademarks of Semiconductor Components Industries, LLC (SCILLC). SCILLC reserves the right to make changes without further notice to any products herein. SCILLC makes no warranty, representation or guarantee regarding the suitability of its products for any particular purpose, nor does SCILLC assume any liability arising out of the application or use of any product or circuit, and specifically disclaims any and all liability, including without limitation special, consequential or incidental damages. "Typical" parameters which may be provided in SCILLC data sheets and/or specifications can and do vary in different applications and actual performance may vary over time. All operating parameters, including "Typicals" must be validated for each customer application by customer's technical experts. SCILLC does not convey any license under its patent rights nor the rights of others. SCILLC products are not designed, intended, or authorized for use as components in systems intended for surgical implant into the body, or other applications intended to support or sustain life, or for any other application in which the failure of the SCILLC product could create a situation where personal injury or death may occur. Should Buyer purchase or use SCILLC products for any such unintended or unauthorized application, Buyer shall indemnify and hold SCILLC and its officers, employees, subsidiaries, affiliates, and distributors harmless against all claims, costs, damages, and expenses, and reasonable attorney fees arising out of, directly or indirectly, any claim of personal injury or death associated with such unintended or unauthorized use, even if such claim alleges that SCILLC was negligent regarding the design or manufacture of the part. SCILLC is an Equal Opportunity/Affirmative Action Employer. This literature is subject to all applicable copyright laws and is not for resale in any manner.

PUBLICATION ORDERING INFORMATION

LITERATURE FULFILLMENT:
Literature Distribution Center for ON Semiconductor
P.O. Box 5163, Denver, Colorado 80217 USA
Phone: 303-675-2175 or 800-344-3860 Toll Free USA/Canada
Fax: 303-675-2176 or 800-344-3867 Toll Free USA/Canada
Email: orderlit@onsemi.com

N. American Technical Support: 800-282-9855 Toll Free
USA/Canada
Europe, Middle East and Africa Technical Support:
Phone: 421 33 790 2910
Japan Customer Focus Center
Phone: 81-3-5773-3850

ON Semiconductor Website: www.onsemi.com
Order Literature: <http://www.onsemi.com/orderlit>

For additional information, please contact your local Sales Representative

NJL4281D/D