

LTC3855EFE

Dual Output Synchronous Buck Converter

DESCRIPTION

Demonstration circuit DC1617A is a dual output synchronous buck converter featuring the LTC[®]3855EFE in a high density, two sided drop-in layout with power components on the top and the control circuit on the bottom. The package style for the LTC3855EFE is a 38-lead TSSOP.

The board comes in two assembly types. The –A assembly provides 2.5V/15A and 1.8V/15A from a 4.5V to 26V input. DCR inductor sensing is used to provide the highest efficiency. The current limit is NTC compensated to provide the minimal amount of variation over temperature. The –B assembly is a high power, 12V/6A and 5V/10A converter with a 13V to 36V input. A sense resistor is used to provide a precise current limit.

The main features of the board are listed below:

- Remote sensing for V_{OUT2} on the –A assembly. On the –B assembly, the diffamp is bypassed since V_{OUT2} is > 3.3V.

- Optional resistors for single output dual phase operation.
- PLLIN pin for synchronization to an external clock which can be used in conjunction with PHASMD pin and CLKOUT pin for up to 12-phase operation.
- Selectable light load operating modes of pulse skip, Burst Mode[®] operation or FCM.
- TRACK/SS pins for external rail tracking.
- RUN pins and PGOOD pins for each phase.

Design files for this circuit board are available at <http://www.linear.com/demo>

LT, LT, LTC, LTM, Linear Technology and the Linear logo are registered trademarks of Linear Technology Corporation. All other trademarks are the property of their respective owners.

PERFORMANCE SUMMARY (T_A = 25°C)

–A Assembly

PARAMETER	CONDITIONS	VALUE
Minimum Input Voltage		4.5V
Maximum Input Voltage		26V
Output Voltage V_{OUT1}	$I_{OUT1} = 0A$ TO 15A, $V_{IN} = 4.5V$ to 26V	2.5V ±2%
Output Voltage V_{OUT2}	$I_{OUT2} = 0A$ TO 15A, $V_{IN} = 4.5V$ to 26V	1.8V ±2%
V_{OUT1} Maximum Output Current, I_{OUT1}	$V_{IN} = 4.5V$ to 26V, $V_{OUT1} = 2.5V$	15A
V_{OUT2} Maximum Output Current, I_{OUT2}	$V_{IN} = 4.5V$ to 26V, $V_{OUT2} = 1.8V$	15A
Nominal Switching Frequency		250kHz
Efficiency, See Figure 3	$V_{OUT1} = 2.5V$, $I_{OUT1} = 15A$, $V_{IN} = 12V$	93.0% Typical
	$V_{OUT2} = 1.8V$, $I_{OUT2} = 15A$, $V_{IN} = 12V$	91.7% Typical

DEMO MANUAL DC1617A

PERFORMANCE SUMMARY (T_A = 25°C)

–B Assembly

PARAMETER	CONDITIONS	VALUE
Minimum Input Voltage		13V
Maximum Input Voltage		36V
Output Voltage V _{OUT1}	I _{OUT1} = 0A TO 6A, V _{IN} = 13V to 36V	12V ±3%
Output Voltage V _{OUT2}	I _{OUT2} = 0A TO 10A, V _{IN} = 13V to 36V	5V ±3%
V _{OUT1} Maximum Output Current, I _{OUT1}	V _{IN} = 13V to 36V, V _{OUT1} = 12V	6A
V _{OUT2} Maximum Output Current, I _{OUT2}	V _{IN} = 13V to 36V, V _{OUT2} = 5V	10A
Nominal Switching Frequency		250kHz
Efficiency, See Figure 4	V _{OUT1} = 12V, I _{OUT1} = 6A, V _{IN} = 24V	97.1% Typical
	V _{OUT2} = 5V, I _{OUT2} = 10A, V _{IN} = 24V	94.1% Typical

QUICK START PROCEDURE

Demonstration circuit 1617A is easy to set up to evaluate the performance of the LTC3855EFE. Please refer to Figure 1 for proper measurement equipment setup and follow the procedure below.

1) With power off, connect the input supply, load and meters as shown in Figure 1. Preset the load to 0A and V_{IN} supply to be 0V. Place jumpers in the following positions:

JP1 RUN1 ON

JP2 RUN2 ON

JP3 MODE FCM

2) Set the input voltage to within the nominal input voltage range and check for the proper output voltage with no load and then full load. See below:

–A assembly

V_{IN} = 4.5V to 26V

V_{OUT1} = 2.5V/15A, V_{OUT2} = 1.8V/15A

–B assembly

V_{IN} = 13V to 36V

V_{OUT1} = 12V/6A, V_{OUT2} = 5V/10A

3) Once the DC regulation is confirmed, observe the output voltage ripple, load step response, efficiency and other parameters.

Note 1. Do not apply load between the VO1⁺ and VO1[–] pins or between the VO2_SNS⁺ and VO2_SNS[–] pins. These pins are only intended to Kelvin sense the output voltage across COUT1 and COUT4. Heavy load currents applied across the VO1[±] sense pins will damage these sense traces. Heavy load currents across the VO2_SNS[±] pins will damage the converter.

Note 2. When measuring the output or input voltage ripple, do not use the long ground lead on the oscilloscope probe. See Figure 2 for the proper scope probe technique. Short, stiff leads need to be soldered to the (+) and (–) terminals of an output capacitor. The probe's ground ring needs to touch the (–) lead and the probe tip needs to touch the (+) lead.

QUICK START PROCEDURE

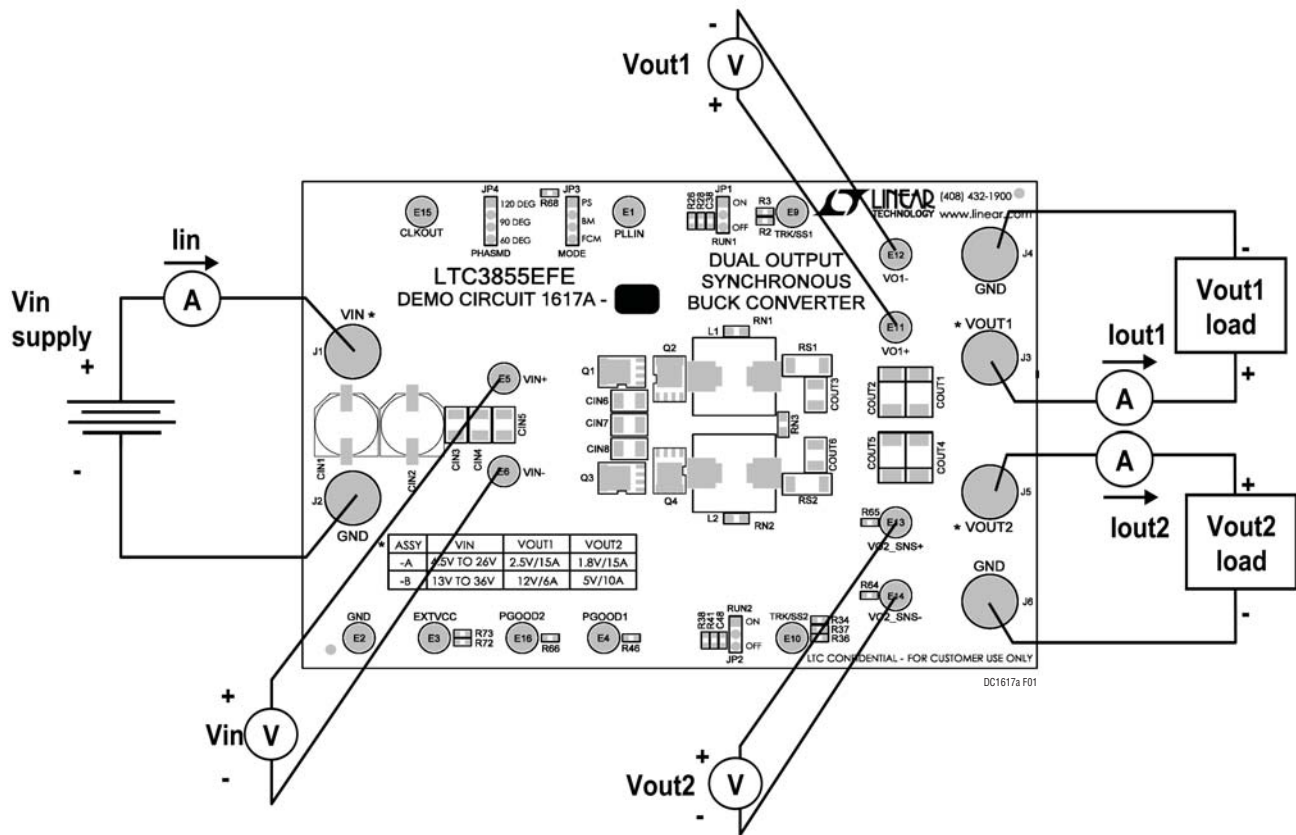

Figure 1. Proper Measurement Equipment Setup.

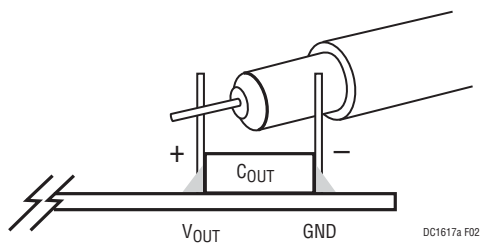

Figure 2. Measuring Output Voltage Ripple

QUICK START PROCEDURE

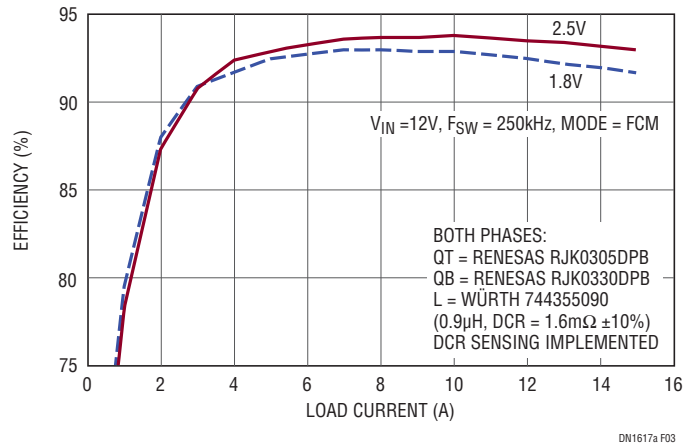

Figure 3. Typical Efficiency Curves of the -A Assembly

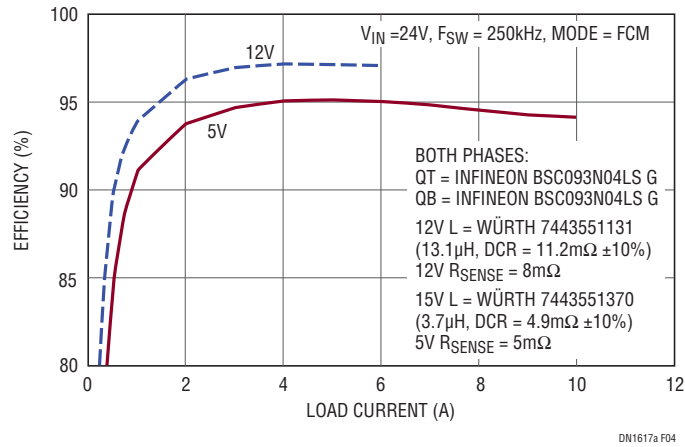

Figure 4. Typical Efficiency Curves of the -B Assembly

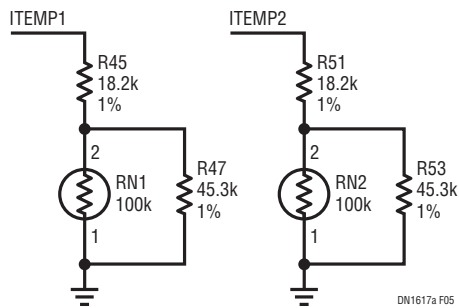

Figure 5. Temperature Compensation Network for DCR Sensing, As Used on the -A Assembly

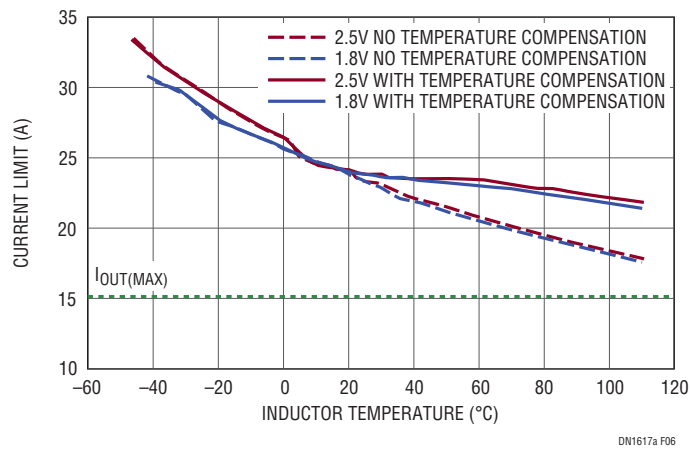

Figure 6. Current Limit vs Inductor Temperature for the -A Assembly

SINGLE OUTPUT/DUAL PHASE OPERATION

A single output/dual phase converter may be preferred for high output current applications. The benefits of single output/dual phase operation is lower ripple current through the input and output capacitors, faster load step response and simplified thermal design. To implement single output/dual phase operation, make the following modifications:

- Tie V_{OUT1} to V_{OUT2} by tying together the exposed copper pads on the V_{OUT} shapes with pieces of heavy copper foil.
- Tie ITH1 to ITH2 by stuffing 0Ω at R49.
- Tie VFB1 to VFB2 by stuffing 0Ω at R50.
- Tie TRK/SS1 to TRK/SS2 by stuffing 0Ω at R52.
- Tie RUN1 to RUN2 by stuffing 0Ω at R55.
- Keep the ILIM pins at the same potential or tie them together by stuffing 0Ω at R71.
- Keep the ITEMPS pins at the same potential or tie them together by stuffing 0Ω at R67.
- Remove the redundant ITH compensation network, VFB divider and TRACK/SS cap.
- Recompensate if necessary.

TEMPERATURE COMPENSATION NETWORK FOR DCR SENSING

As the temperature of an inductor increases, its DCR goes up due to the positive temperature coefficient of the copper winding. The NTC temperature compensation network on the ITEMPS pins of the –A assembly (see Figure 5) allows $V_{SENSE(maximum)}$ of the LTC3855 to track the DCR of the inductor which provides a much smaller variation of the current limit over temperature. The temperature of inductors L1 and L2 are sensed with the NTC thermistors at RN1 and RN2. R45, R47, R51 and R53 are used for linearization.

Figure 6 shows the current limit of the –A assembly versus inductor temperature with and without the temperature compensation network stuffed. As can be seen, the temperature compensation network greatly reduces the drop in the current limit over temperature and allows the current limit to be more accurate.

PARTS LIST

-A Assembly (2.5V and 1.8V Converter)

ITEM	QTY	REFERENCE	PART DESCRIPTION	MANUFACTURER/PART NUMBER
Required Circuit Components				
1	1	C11	CAP 0805 4.7 μ F 10% 10V X5R	AVX 0805ZD475KAT2A
2	2	C14, C15	CAP 0603 0.22 μ F 10% 25V X7R	AVX 06033C224KAT2A
3	1	C17	CAP 0603 0.1 μ F 10% 50V X7R	AVX 06035C104KAT2A
4	4	C2, C20, C21, C47	CAP 0603 0.1 μ F 10% 25V X7R	AVX 06033C104KAT2A
5	2	C37, C49	CAP 0603 22pF 5% 50V NPO	AVX 06035A220JAT2A
6	1	C41	CAP 0603 1nF 10% 50V X7R	AVX 06035C102KAT2A
7	1	C42	CAP 0603 220pF 5% 25V NPO	AVX 06033A221JAT2A
8	1	C43	CAP 0603 330pF 5% 25V NPO	AVX 06035A331JAT2A
9	1	C44	CAP 0603 3.3nF 10% 50V X7R	AVX 06035C332KAT2A
10	1	CIN1	CAP 220 μ F 20% 50V ALUM ELEC	PANASONIC EEEFK1H221P
11	6	CIN3 TO CIN8	CAP 1210 4.7 μ F 10% 50V X7R	MURATA GRM32ER71H475KA88L
12	4	COUT1, COUT2, COUT4, COUT5	CAP 7343 330 μ F 20% 4V POLYMER TANT	KEMET T520V337M004ATE009
13	2	COUT3, COUT6	CAP 1210 100 μ F 20% 6.3V X5R	TDK C3225X5R0J107M
14	2	D1, D2	DIODE SCHOTTKY 1A 100V PWRD1123	DIODES INC DFLS1100-7
15	2	L1, L2	INDUCTOR 0.9 μ H	WÜRTH 744355090
16	2	Q1, Q3	MOSFET POWER N-CH LPAK	RENESAS RJK0305DPB
17	2	Q2, Q4	MOSFET POWER N-CH LPAK	RENESAS RJK0330DPB
18	12	R3, R7, R9, R10, R11, R44, R25, R36, R58, R62, R63, R70	RES 0603 0 Ω JUMPER	VISHAY CRCW06030000Z0EA
19	1	R18	RES 0603 2.2 Ω 5% 1/10W	VISHAY CRCW06032R20JNEA
20	1	R27	RES 0603 63.4k 1% 1/10W	VISHAY CRCW060363K4FKEA
21	4	R31, R32, R33, R68	RES 0603 20k 1% 1/10W	VISHAY CRCW060320K0FKEA
22	1	R35	RES 0603 11.8k 1% 1/10W	VISHAY CRCW060311K8FKEA
23	1	R43	RES 0603 40.2k 1% 1/10W	VISHAY CRCW060340K2FKEA
24	2	R45, R51	RES 0603 18.2k 1% 1/10W	VISHAY CRCW060318K2FKEA
25	2	R46, R66	RES 0603 100k 1% 1/10W	VISHAY CRCW0603100KFKEA
26	2	R47, R53	RES 0603 45.3k 1/10W	VISHAY CRCW060345K3FKEA
27	2	R56, R59	RES 0603 3.09k 1% 1/10W	VISHAY CRCW06033K09FKEA
28	1	R57	RES 0603 8.45k 1% 1/10W	VISHAY CRCW06038K45FKEA
29	1	R60	RES 0603 11k 1% 1/10W	VISHAY CRCW060311K0FKEA
30	2	R64, R65	RES 0603 10 Ω 5% 1/10W	VISHAY CRCW060310R0JNEA
31	2	RN1, RN2	THERMISTOR 0603 100k 5%	MURATA NCP18WF104J03RB
32	2	RS1, RS2	RES 2010 0 0m Ω 1% 1/2W	TEPRO RN6083
33	1	U1	IC DUAL OUTPUT BUCK CONTROLLER	LINEAR TECHNOLOGY LTC3855EFE#PBF

DEMO MANUAL DC1617A

PARTS LIST

-A Assembly (2.5V and 1.8V Converter)

ITEM	QTY	REFERENCE	PART DESCRIPTION	MANUFACTURER/PART NUMBER
Additional Circuit Components				
1	0	C38, C48, C51, C52	CAP 0603	OPTION
2	1	C50	CAP 0603 1 μ F 10% 16V X5R	AVX 0603YD105KAT
3	0	CIN2	CAP ALUM ELEC - PANASONIC SIZE G	OPTION
4	0	CIN9 TO CIN11	CAP 1210	OPTION
5	0	Q5 TO Q8	MOSFET POWER LPAK	OPTION
6	0	R2, R12, R26, R28 TO R30, R34, R37 TO R42, R49, R50, R52, R55, R61, R67, R69, R71 TO R73	RES 0603	OPTION
7	0	RN3	THERMISTOR 0603	OPTION
Hardware				
1	14	E1 TO E6, E9, E10 TO E16	TESTPOINT TURRET 0.094" PbF	MILL-MAX 2501-2-00-80-00-00-07-0
2	6	J1, J2, J3, J4, J5, J6	JACK BANANA	KEYSTONE 575-4
3	2	JP1, JP2	HEADER 3-PIN 0.079 SINGLE ROW	SAMTEC TMM-103-02-L-S
4	4	JP1 TO JP4	SHUNT 0.079" CENTER	SAMTEC 2SN-BK-G
5	2	JP3, JP4	HEADER 4-PIN 0.079 SINGLE ROW	SAMTEC TMM-104-02-L-S

PARTS LIST

-B Assembly (12V and 5V Converter)

ITEM	QTY	REFERENCE	PART DESCRIPTION	MANUFACTURER/PART NUMBER
Required Circuit Components				
1	1	C11	CAP 0805 4.7μF 10% 10V X5R	AVX 0805ZD475KAT2A
2	2	C14, C15	CAP 0603 1nF 10% 50V X7R	AVX 06035C102KAT
3	5	C2, C17, C20, C21, C47	CAP 0603 0.1μF 10% 50V X7R	AVX 06035C104KAT2A
4	1	C41	CAP 0603 3.3nF 10% 50V X7R	AVX 06035C332KAT2A
5	2	C42, C43	CAP 0603 47pF 5% 25V NPO	AVX 06033A470JAT2A
6	1	C44	CAP 0603 1.5nF 10% 50V X7R	AVX 06035C152KAT2A
7	1	CIN1	CAP 220μF 20% 50V ALUM ELEC	PANASONIC EEEFK1H221P
8	6	CIN3 TO CIN8	CAP 1210 4.7μF 10% 50V X7R	MURATA GRM32ER71H475KA88L
9	1	COU1	CAP 7343 68μF 20% 16V POLYMER TANT	KEMET T520D686M016ATE050
10	2	COU3, COU6	CAP 1210 10μF 10% 25V X5R	KEMET C1210C106K3PAC7533
11	1	COU4	CAP 7343 220μF 20% 6V POLYMER TANT	KEMET T520V227M006ATE012
12	2	D1, D2	DIODE SCHOTTKY 1A 100V PWRDI123	DIODES INC DFSL1100-7
13	1	L1	INDUCTOR 13μH	WÜRTH 7443551131
14	1	L2	INDUCTOR 3.7μH	WÜRTH 7443551370
15	4	Q1, Q2, Q3, Q4	MOSFET POWER N-CH LFPAK	INFINEON BSC093N04LS G
16	13	R3, R7, R9, R10, R12, R25, R36, R42, R61, R64, R65, R69, R73	RES 0603 0Ω JUMPER	VISHAY CRCW060300000Z0EA
17	1	R18	RES 0603 2.2Ω 5% 1/10W	VISHAY CRCW06032R20JNEA
18	1	R27	RES 0603 383k 1% 1/10W	VISHAY CRCW0603383KFKEA
19	4	R29, R30, R39, R40	RES 0603 10Ω 5% 1/10W	VISHAY CRCW060310R0JNEA
20	2	R31, R35	RES 0603 15k 1% 1/10W	VISHAY CRCW060315K0FKEA
21	3	R32, R33, R68	RES 0603 20k 1% 1/10W	VISHAY CRCW060320K0FKEA
22	1	R43	RES 0603 147k 1% 1/10W	VISHAY CRCW0603147KFKEA
23	2	R46, R66	RES 0603 100k 1% 1/10W	VISHAY CRCW0603100KFKEA
24	1	RS1	RES 2010 0.008Ω 1% 1/2W	VISHAY WSL20108L00FEA
25	1	RS2	RES 2010 0.005Ω 1% 1/2W	VISHAY WSL20105L00FEA
26	1	U1	IC DUAL OUTPUT BUCK CONTROLLER	LINEAR TECHNOLOGY LTC3855EFE#PBF
Additional Circuit Components				
1	0	C37, C38, C48, C49, C51, C52	CAP 0603	OPTION
2	1	C50	CAP 0603 1μF 10% 16V X5R	AVX 0603YD105KAT
3	0	CIN2	CAP ALUM ELEC - PANASONIC SIZE G	OPTION
4	0	CIN9 TO CIN11	CAP 1210	OPTION
5	0	COU2, COU5	CAP 7343	OPTION
6	0	Q5 TO Q8	MOSFET POWER LFPAK	OPTION
7	0	R2, R11, R26, R28, R34, R37, R38, R41, R44, R45, R47, R49 TO R53	RES 0603	OPTION
8	0	RN1 TO RN3	THERMISTOR 0603	OPTION
Hardware				
1	14	E1 TO E6, E9, E10, E16	TESTPOINT TURRET 0.094" PbF	MILL-MAX 2501-2-00-80-00-00-07-0
2	6	J1, J2, J3, J4, J5, J6	JACK BANANA	KEYSTONE 575-4
3	2	JP1, JP2	HEADER 3-PIN 0.079 SINGLE ROW	SAMTEC TMM-103-02-L-S
4	4	JP1 TO JP4	SHUNT .0079" CENTER	SAMTEC 2SN-BK-G
5	2	JP3, JP4	HEADER 4-PIN 0.079 SINGLE ROW	SAMTEC TMM-104-02--L-S

DEMO MANUAL DC1617A

SCHEMATIC DIAGRAM

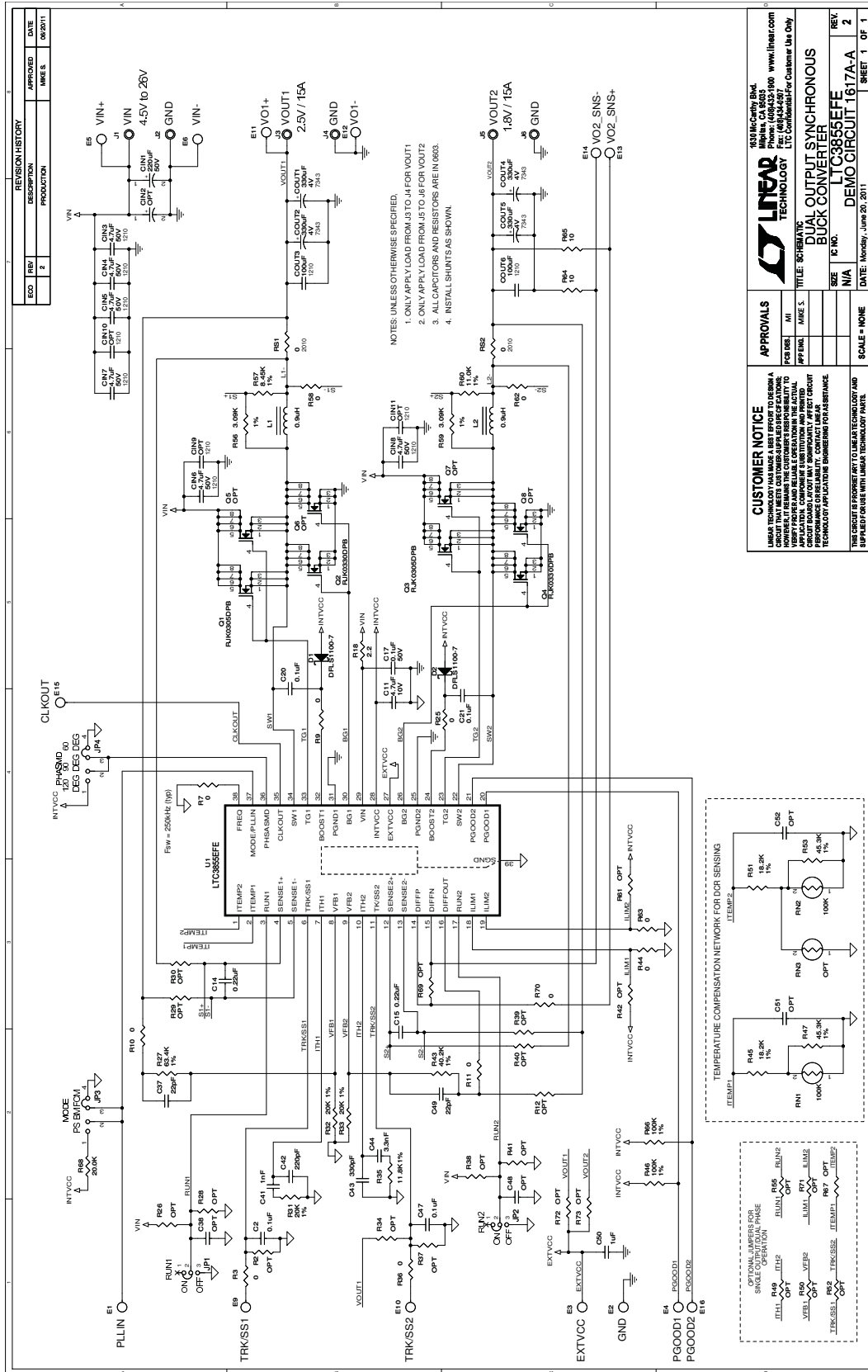

DEMO MANUAL DC1617A

DEMONSTRATION BOARD IMPORTANT NOTICE

Linear Technology Corporation (LTC) provides the enclosed product(s) under the following **AS IS** conditions:

This demonstration board (DEMO BOARD) kit being sold or provided by Linear Technology is intended for use for **ENGINEERING DEVELOPMENT OR EVALUATION PURPOSES ONLY** and is not provided by LTC for commercial use. As such, the DEMO BOARD herein may not be complete in terms of required design-, marketing-, and/or manufacturing-related protective considerations, including but not limited to product safety measures typically found in finished commercial goods. As a prototype, this product does not fall within the scope of the European Union directive on electromagnetic compatibility and therefore may or may not meet the technical requirements of the directive, or other regulations.

If this evaluation kit does not meet the specifications recited in the DEMO BOARD manual the kit may be returned within 30 days from the date of delivery for a full refund. **THE FOREGOING WARRANTY IS THE EXCLUSIVE WARRANTY MADE BY THE SELLER TO BUYER AND IS IN LIEU OF ALL OTHER WARRANTIES, EXPRESSED, IMPLIED, OR STATUTORY, INCLUDING ANY WARRANTY OF MERCHANTABILITY OR FITNESS FOR ANY PARTICULAR PURPOSE. EXCEPT TO THE EXTENT OF THIS INDEMNITY, NEITHER PARTY SHALL BE LIABLE TO THE OTHER FOR ANY INDIRECT, SPECIAL, INCIDENTAL, OR CONSEQUENTIAL DAMAGES.**

The user assumes all responsibility and liability for proper and safe handling of the goods. Further, the user releases LTC from all claims arising from the handling or use of the goods. Due to the open construction of the product, it is the user's responsibility to take any and all appropriate precautions with regard to electrostatic discharge. Also be aware that the products herein may not be regulatory compliant or agency certified (FCC, UL, CE, etc.).

No License is granted under any patent right or other intellectual property whatsoever. **LTC assumes no liability for applications assistance, customer product design, software performance, or infringement of patents or any other intellectual property rights of any kind.**

LTC currently services a variety of customers for products around the world, and therefore this transaction **is not exclusive**.

Please read the DEMO BOARD manual prior to handling the product. Persons handling this product must have electronics training and observe good laboratory practice standards. **Common sense is encouraged.**

This notice contains important safety information about temperatures and voltages. For further safety concerns, please contact a LTC application engineer.

Mailing Address:

Linear Technology
1630 McCarthy Blvd.
Milpitas, CA 95035

Copyright © 2004, Linear Technology Corporation

dc1617af