

Round Through-Hole LED Lamp (5 mm)

OVLFX3C7 Series

- High brightness with well-defined spatial radiation patterns
- UV-resistant epoxy lens
- 30° Beam Angle

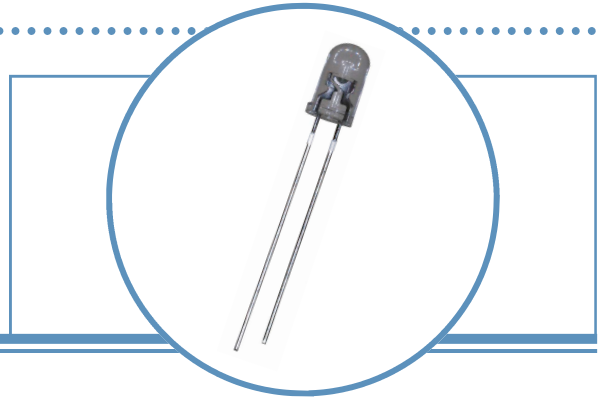

Each device in the **OVLFX3C7** series is a high-intensity LED mounted in a clear plastic T-1 $\frac{3}{4}$ package. The LED provides a well-defined and even emission pattern. The UV-resistant epoxy lens makes this device an optimal solution for outdoor applications.

Applications

- Traffic and pedestrian signals
- Signage and architectural lighting
- Backlighting
- Automotive

Part Number	Material	Emitted Color	Intensity Typ. mcd	Lens Color
OVLFB3C7	InGaN	Blue	5,200	Clear
OVLFG3C7	InGaN	Green	16,000	Clear
OVLFR3C7	AllnGaP	Red	7,400	Clear
OVLFY3C7	AllnGaP	Yellow	7,400	Clear

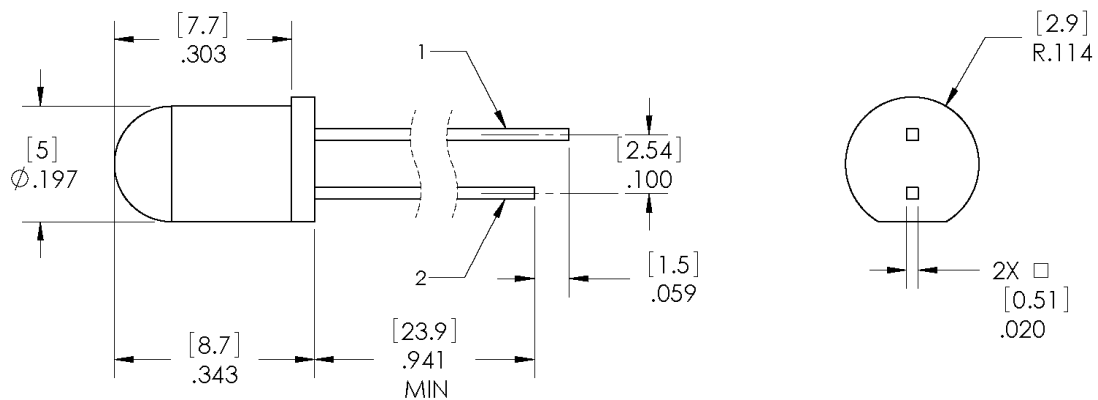

1 ANODE 2 CATHODE DIMENSIONS ARE IN INCHES AND [MILLIMETERS].



RoHS



Leadframe material is iron alloy with tin-plated leads

DO NOT LOOK DIRECTLY AT LED WITH UNSHIELDED EYES OR DAMAGE TO RETINA MAY OCCUR.

OPTEK reserves the right to make changes at any time in order to improve design and to supply the best product possible.

Round Through-Hole LED Lamp

OVLFX3C7 Series



Absolute Maximum Ratings

T_A = 25° C unless otherwise noted

Storage Temperature Range		-40 ~ +100 °C
Operating Temperature Range		-40 ~ +100 °C
Reverse Voltage		5 V
Continuous Forward Current	Blue, Green	25 mA
	Red, Yellow	50 mA
Peak Forward Current (10% Duty Cycle, 1 kHz)	Blue, Green	100 mA
	Red, Yellow	100 mA
Power Dissipation	Blue, Green	100 mW
	Red, Yellow	120 mW
Current Linearity vs Ambient Temperature	Blue, Green	-0.29 mA/°C
	Red, Yellow	-0.72 mA/°C
Electrostatic Discharge Classification (JEDEC-JESD22-A114F)		Class 1C
LED Junction Temperature		125°C
Lead Soldering Temperature (4 mm from the base of the epoxy bulb)		260°C / 5 seconds

Electrical Characteristics

T_A = 25° C unless otherwise noted

SYMBOL	PARAMETER	COLOR	MIN	TYP	MAX	UNITS	CONDITIONS
I _V	Luminous Intensity	Blue	3,115	5,200	----	mcd	I _F = 20 mA
		Green	8,550	16,000	----		
		Red	4,360	7,400	----		
		Yellow	4,360	7,400	----		
V _F	Forward Voltage	Blue	2.6	3.4	4.0	V	I _F = 20 mA
		Green					
		Red	1.8	2.0	2.4		
		Yellow					
I _R	Reverse Current	Blue	----	----	10	µA	V _R = 5 V
		Green					
		Red					
		Yellow					
λ _D	Dominant Wavelength	Blue	460	470	475	nm	I _F = 20 mA
		Green	519	525	531		
		Red	620	623	630		
		Yellow	585	589	595		
Δλ	Spectra Half Width	Blue	----	25	----	nm	I _F = 20 mA
		Green					
		Red					
		Yellow					
2Θ _{1/2} -H	50% Power Angle		----	30	----	deg	I _F = 20 mA

OPTEK reserves the right to make changes at any time in order to improve design and to supply the best product possible.

Round Through-Hole LED Lamp

OVLFX3C7 Series



Standard Bins

LEDs are sorted to luminous intensity (I_V), forward voltage (V_F) and dominant wavelength (nm) bins listed below. Each bag consists of a single intensity bin, single voltage bin and a single color bin. Orders are filled using all intensity and color bins listed in the following tables. Optek will not accept orders for single intensity bins, single voltage bins or single color bins.

Luminous Intensity (I_V) @ 20mA

BLUE: OVLFB3C7		
IV Code	Min (mcd)	Max (mcd)
0V	3,115	4,360
0W	4,360	6,105
0X	6,105	8,550
0Y	8,550	11,970
GREEN: OVLFG3C7		
IV Code	Min (mcd)	Max (mcd)
0Y	8,550	11,670
0Z	11,970	16,758
Z1	16,758	23,500
Z2	23,500	32,800

Forward Voltage (V_F)

BLUE: OVLFB3C7 & GREEN: OVLFG3C7		
VF Code	Min	Max
A	2.6	2.8
B	2.8	3.0
C	3.0	3.2
D	3.2	3.4
E	3.4	3.6
F	3.6	3.8
G	3.8	4.0

Dominant Wavelength (nm)

BLUE: OVLFB3C7		
Color Code	Min (nm)	Max (nm)
BC	460	465
BD	465	470
BE	470	475
GREEN: OVLFG3C7		
Color Code	Min (nm)	Max (nm)
FB	519	523
FC	523	527
FD	527	531

Luminous Intensity (I_V) @ 20mA

RED: OVLFR3C7		
IV Code	Min (mcd)	Max (mcd)
0W	4,360	6,105
0X	6,105	8,550
0Y	8,550	11,970
0Z	11,970	16,758
YELLOW: OVLFY3C7		
IV Code	Min (mcd)	Max (mcd)
0W	4,360	6,105
0X	6,105	8,550
0Y	8,550	11,970
0Z	11,970	16,758

Forward Voltage (V_F)

RED: OVLFR3C7 & YELLOW: OVLFY3C7		
VF Code	Min	Max
A	1.8	2.0
B	2.0	2.2
C	2.2	2.4

Dominant Wavelength (nm)

RED: OVLFR3C7		
Color Code	Min (nm)	Max (nm)
RA	620	625
RB	625	630
YELLOW: OVLFY3C7		
Color Code	Min (nm)	Max (nm)
YC	585	587
YD	587	589
YE	589	591
YF	591	593
YG	593	595

OPTEK reserves the right to make changes at any time in order to improve design and to supply the best product possible.

Typical Electro-Optical Characteristics Curves (BLUE)

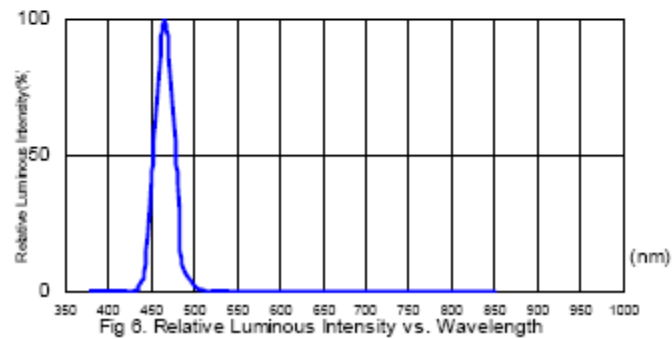
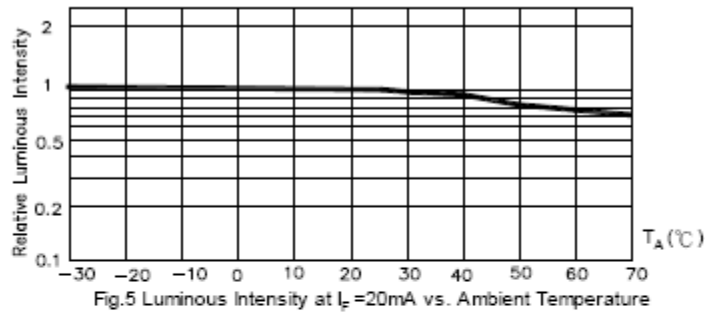
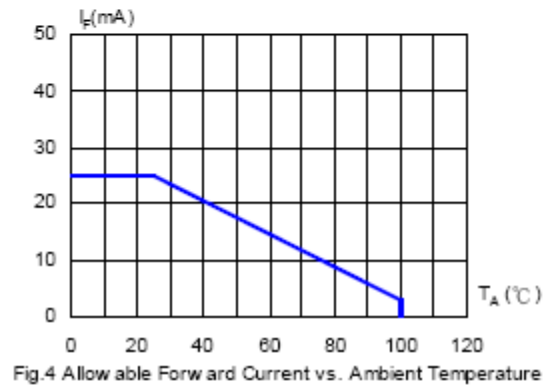
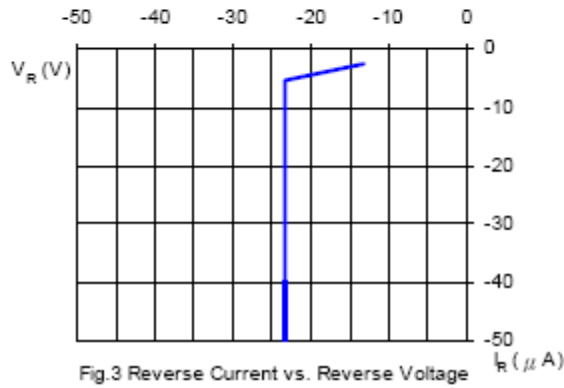
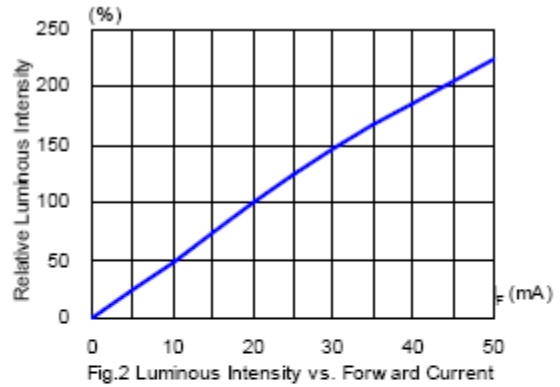
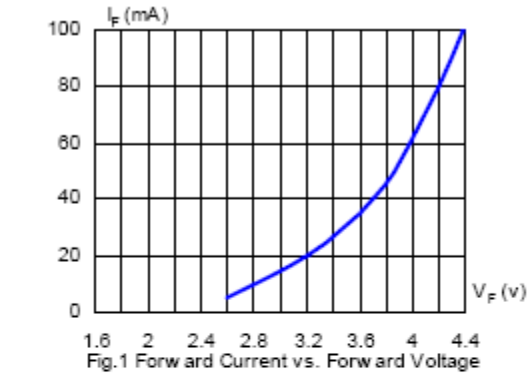

OPTEK reserves the right to make changes at any time in order to improve design and to supply the best product possible.

Typical Electro-Optical Characteristics Curves (GREEN)

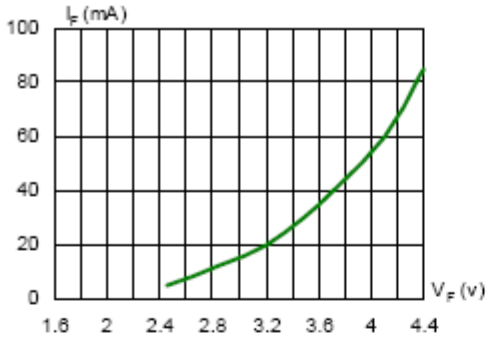

Fig.1 Forward Current vs. Forward Voltage

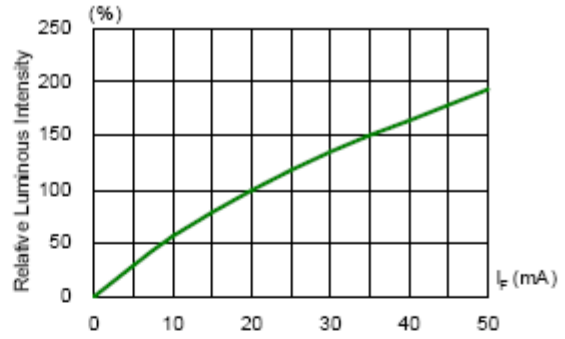

Fig.2 Luminous Intensity vs. Forward Current

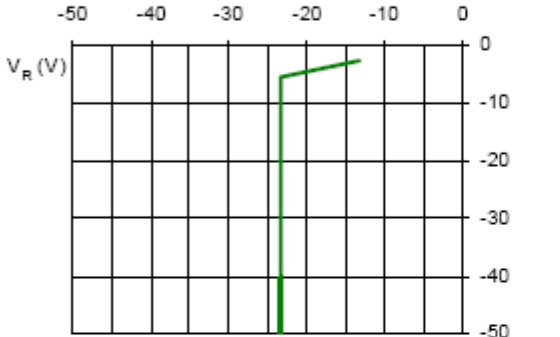

Fig.3 Reverse Current vs. Reverse Voltage

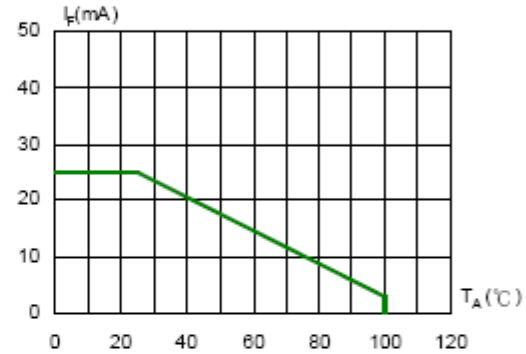

Fig.4 Allowable Forward Current vs. Ambient Temperature

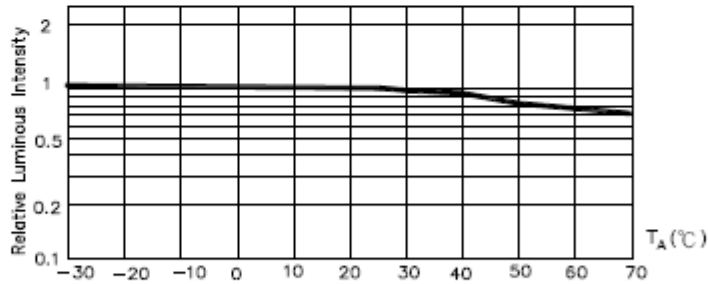

Fig.5 Luminous Intensity at $I_F=20mA$ vs. Ambient Temperature

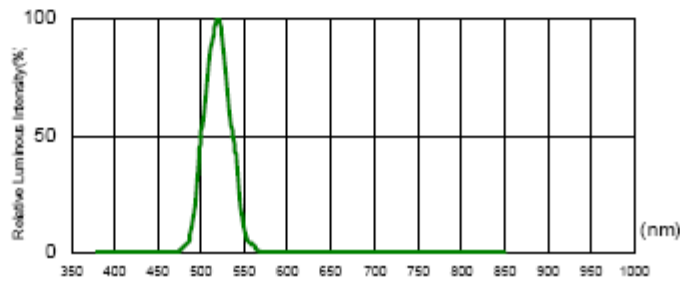

Fig.6. Relative Luminous Intensity vs. Wavelength

OPTEK reserves the right to make changes at any time in order to improve design and to supply the best product possible.

Typical Electro-Optical Characteristics Curves (RED)

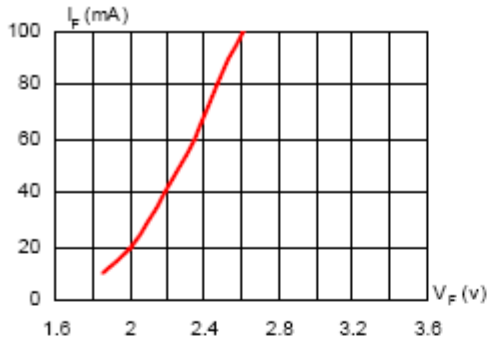

Fig.1 Forward Current vs. Forward Voltage

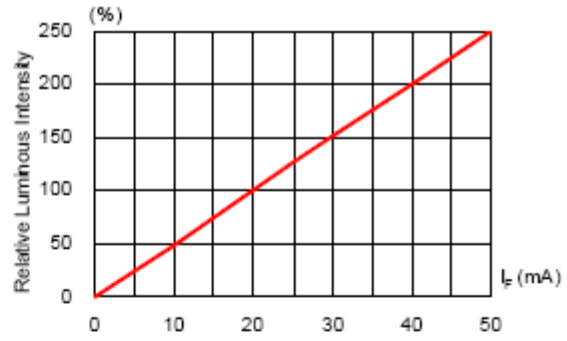

Fig.2 Luminous Intensity vs. Forward Current



Fig.3 Reverse Current vs. Reverse Voltage

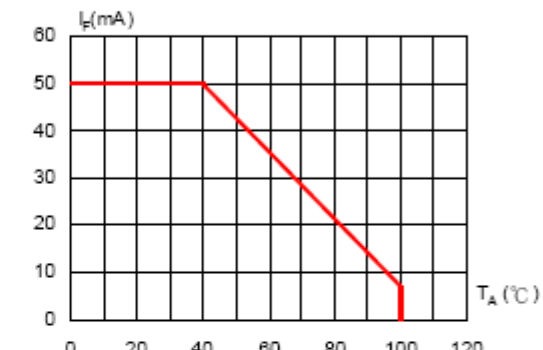

Fig.4 Allowable Forward Current vs. Ambient Temperature

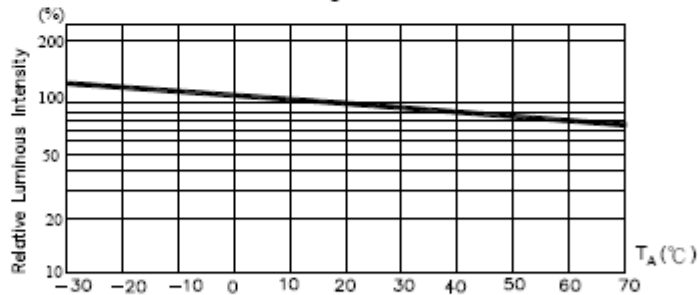

Fig.5 Luminous Intensity at $I_F=20mA$ vs. Ambient Temperature

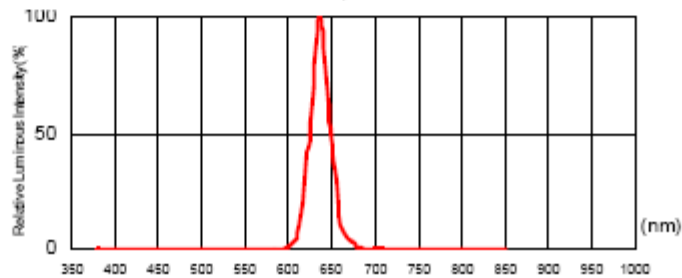

Fig.6. Relative Luminous Intensity vs. Wavelength

OPTEK reserves the right to make changes at any time in order to improve design and to supply the best product possible.

Typical Electro-Optical Characteristics Curves (YELLOW)

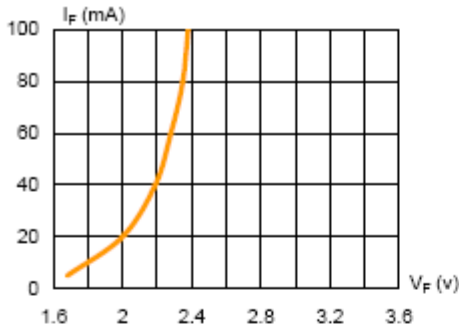

Fig.1 Forward Current vs. Forward Voltage

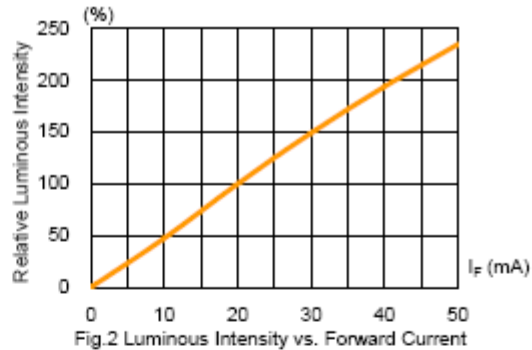

Fig.2 Luminous Intensity vs. Forward Current

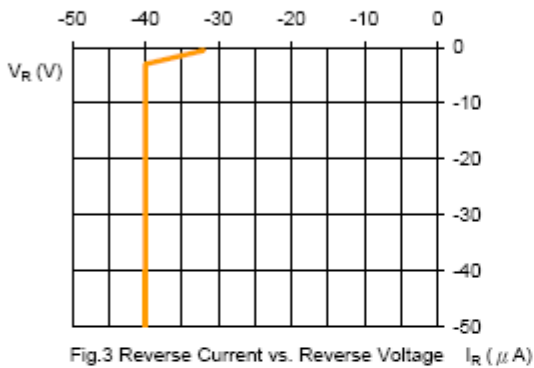

Fig.3 Reverse Current vs. Reverse Voltage

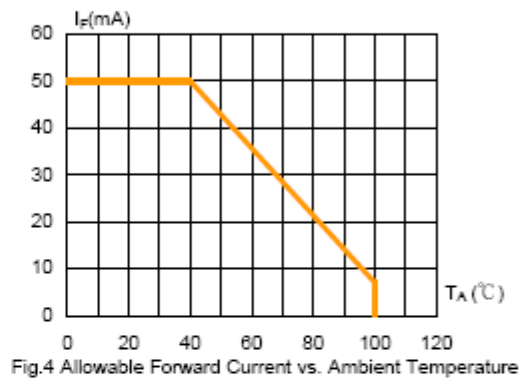

Fig.4 Allowable Forward Current vs. Ambient Temperature

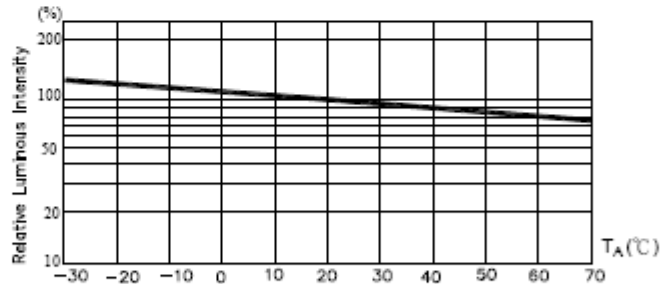

Fig.5 Luminous Intensity at $I_F = 20mA$ vs. Ambient Temperature

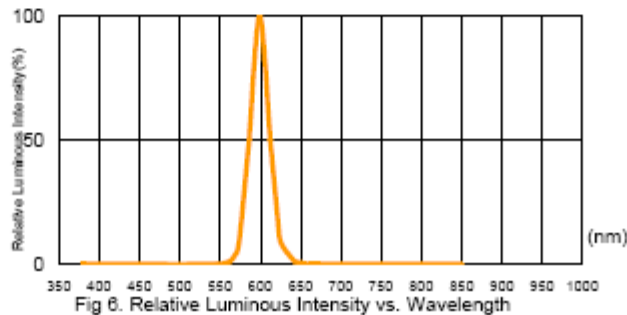

Fig.6. Relative Luminous Intensity vs. Wavelength

OPTEK reserves the right to make changes at any time in order to improve design and to supply the best product possible.

Round Through-Hole LED Lamp

OVLFX3C7 Series



Beam Pattern

(RED) and (YELLOW)

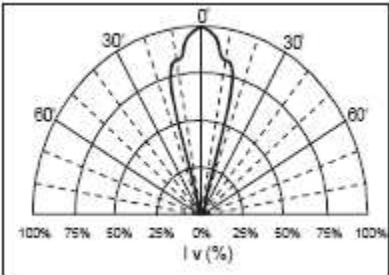

(BLUE) and (GREEN)

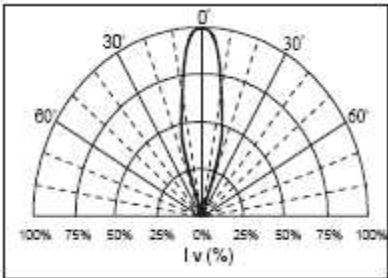

Packaging: 500 pcs per bulk bag with desiccant

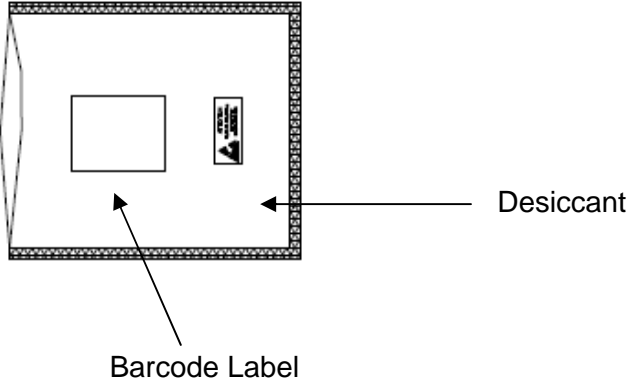

OPTEK reserves the right to make changes at any time in order to improve design and to supply the best product possible.

Round Through-Hole LED Lamp

OVLFX3C7 Series



Reliability Test

LED lamps are checked by reliability tests based on MIL standards.

Classification	Test Item	Standard Test Method	Test Conditions	Duration	Unit	Acc / Rej Criteria	Result
Life Test	Operation Life Test (OLT)	MIL-STD-750D Method 1026.3	$T_A=25^{\circ}\text{C}$, $I_F=30\text{mA}$ *	1000 Hrs	100	0 / 1	Pass
Environment Test	High Temperature Storage (HTS)	MIL-STD-750D Method 1032.1	$T_A=100^{\circ}\text{C}$	1000 Hrs	100	0 / 1	Pass
	Low Temperature Storage (LTS)	MIL-STD-750D Method 1032.1	$T_A=-40^{\circ}\text{C}$	1000 Hrs	100	0 / 1	Pass
	Temp. & Humidity with Bias (THB)	MIL-STD-750D Method 103B	$T_A=85^{\circ}\text{C}$, $\text{Rh}=85\%$ $I_F=20\text{mA}$ **	500 Hrs	100	0 / 1	Pass
	Thermal Shock Test (TST)	MIL-STD-750D Method 1056.1	$0^{\circ}\text{C} \sim 100^{\circ}\text{C}$ 2min 2min	100 cycles	100	0 / 1	Pass
	Temperature Cycling Test (TCT)	MIL-STD-750D Method 1051.5	$-40^{\circ}\text{C} \sim 25^{\circ}\text{C} \sim 100^{\circ}\text{C} \sim 25^{\circ}\text{C}$ 30min 5min 30min 5min	100 cycles	100	0 / 1	Pass
Mechanical Test	Solderability	MIL-STD-750D Method 2026.4	$235\pm 5^{\circ}\text{C}$, 5 sec	1 time	20	0 / 1	Pass
	Resistance to Soldering Heat	MIL-STD-750D Method 2031.1	$260\pm 5^{\circ}\text{C}$, 10 sec	1 time	20	0 / 1	Pass
	Lead Integrity	MIL-STD-750D Method 2036.3	Load 2.5N (0.25kgf) $0^{\circ} \sim 90^{\circ} \sim 0^{\circ}$, bend	3 times	20	0 / 1	Pass

Remark : (*) $I_F=30\text{mA}$ for AlInGaP chip ; $I_F=20\text{mA}$ for InGaN chip

(**) $I_F=20\text{mA}$ for AlInGaP chip ; $I_F=10\text{mA}$ for InGaN chip

2. Failure Criteria ($T_A=25^{\circ}\text{C}$):

Test Item	Symbol	Test Conditions	Criteria for Judgment	
			Min.	Max.
Luminous Intensity	I_V	$I_F=20\text{mA}$	LSL $\times 0.7$ **	
Voltage (Forward)	V_F	$I_F=20\text{mA}$		USL $\times 1.1$ *

(*) USL : Upper Standard Level , (**) LSL : Lower Standard Level

OPTEK reserves the right to make changes at any time in order to improve design and to supply the best product possible.