

MSTB 2,5/ 6-GF-5,08

Order No.: 1776540

The figure shows a 10-position version of the product

<http://eshop.phoenixcontact.de/phoenix/treeViewClick.do?UID=1776540>Header, Nominal current: 12 A, Nom. voltage: 250 V, Pitch: 5.08 mm,
Number of positions: 6, Color: green, Assembly: Soldering

Commercial data

EAN	4017918038717
Pack	50 pcs.
Customs tariff	85366990
Weight/Piece	0.00422 KG
Catalog page information	Page 249 (CC-2009)

Product notes

WEEE/RoHS-compliant since:
01/01/2003

<http://www.download.phoenixcontact.com>
Please note that the data given here has been taken from the online catalog. For comprehensive information and data, please refer to the user documentation. The General Terms and Conditions of Use apply to Internet downloads.

Technical data

Dimensions / positions

Pitch	5.08 mm
Dimension a	25.4 mm
Number of positions	6
Pin dimensions	1 x 1 mm
Hole diameter	1.4 mm

Technical data

Insulating material group	IIIa
Rated surge voltage (III/3)	4 kV
Rated surge voltage (III/2)	4 kV
Rated surge voltage (II/2)	4 kV
Rated voltage (III/2)	320 V
Rated voltage (II/2)	400 V
Connection in acc. with standard	EN-VDE
Nominal current I_N	12 A
Nominal voltage U_N	250 V
Maximum load current	12 A
Insulating material	PBT
Inflammability class acc. to UL 94	V0

Certificates / Approvals



Certification CB, CSA, CUL, GL, GOST, RS, UL, VDE-PZI

CSA

Nominal voltage U_N	300 V
Nominal current I_N	10 A

CUL

Nominal voltage U_N	300 V
Nominal current I_N	10 A

UL

Nominal voltage U_N	300 V
Nominal current I_N	10 A

Accessories

Item	Designation	Description
Assembly		
1755477	MSTB-BL	Keying cap, for forming sections, plugs onto header pin, green insulating material
Marking		
0804293	SK 5,08/3,8:FORTL.ZAHLEN	Marker card, printed horizontally, self-adhesive, 12 identical decades marked 1-10, 11-20 etc. up to 91-(99)100, sufficient for 120 terminal blocks
Plug/Adapter		
1734401	CR-MSTB	Coding section, inserted into the recess in the header or the inverted plug, red insulating material

Additional products

Item	Designation	Description
General		
1873249	FKC 2,5/ 6-STF-5,08	Plug component, Nominal current: 12 A, Nom. voltage: 250 V, Pitch: 5.08 mm, Number of positions: 6, Connection type: Spring-cage conn., Color: green
1902343	FKCT 2,5/ 6-STF-5,08	Plug component, Nominal current: 12 A, Nom. voltage: 250 V, Pitch: 5.08 mm, Number of positions: 6, Connection type: Spring-cage conn., Color: green
1874141	FKCVR 2,5/ 6-STF-5,08	Plug component, Nominal current: 12 A, Nom. voltage: 250 V, Pitch: 5.08 mm, Number of positions: 6, Connection type: Spring-cage conn., Color: green
1873841	FKCVW 2,5/ 6-STF-5,08	Plug component, Nominal current: 12 A, Nom. voltage: 250 V, Pitch: 5.08 mm, Number of positions: 6, Connection type: Spring-cage conn., Color: green
1777840	FRONT-MSTB 2,5/ 6-STF-5,08	Plug component, Nominal current: 12 A, Nom. voltage: 250 V, Pitch: 5.08 mm, Number of positions: 6, Connection type: Screw connection, Color: green
1778027	MSTB 2,5/ 6-STF-5,08	Plug component, Nominal current: 12 A, Nom. voltage: 250 V, Pitch: 5.08 mm, Number of positions: 6, Connection type: Screw connection, Color: green
1809776	MSTBC 2,5/ 6-STZF-5,08	Plug component, Nominal current: 12 A, Nom. voltage: 320 V, Pitch: 5.08 mm, Number of positions: 6, Connection type: Crimp connection, Color: green
1805343	MSTBT 2,5/ 6-STF-5,08	Plug component, Nominal current: 12 A, Nom. voltage: 250 V, Pitch: 5.08 mm, Number of positions: 6, Connection type: Screw connection, Color: green

1849121	MSTBVK 2,5/ 6-STF-5,08	Plug component, Nominal current: 12 A, Nom. voltage: 320 V, Pitch: 5.08 mm, Number of positions: 6, Connection type: Screw connection, Assembly: DIN rail, Color: green
1835135	MVSTBR 2,5/ 6-STF-5,08	Plug component, Nominal current: 12 A, Nom. voltage: 250 V, Pitch: 5.08 mm, Number of positions: 6, Connection type: Screw connection, Color: green
1834945	MVSTBW 2,5/ 6-STF-5,08	Plug component, Nominal current: 12 A, Nom. voltage: 250 V, Pitch: 5.08 mm, Number of positions: 6, Connection type: Screw connection, Color: green
1883394	QC 1/ 6-STF-5,08	Plug component, Nominal current: 10 A, Nom. voltage: 500 V, Pitch: 5.08 mm, Number of positions: 6, Connection type: Insulation displacement connection QUICKON, Color: green
1853146	TMSTBP 2,5/ 6-STF-5,08	Plug component, Nominal current: 12 A, Nom. voltage: 250 V, Pitch: 5.08 mm, Number of positions: 6, Connection type: Screw connection, Color: green
1859218	UMSTBVK 2,5/ 6-STF-5,08	Plug component, Nominal current: 12 A, Nom. voltage: 320 V, Pitch: 5.08 mm, Number of positions: 6, Connection type: Screw connection, Assembly: DIN rail, Color: green

Diagrams/Drawings

Drilling plan/solder pad geometry

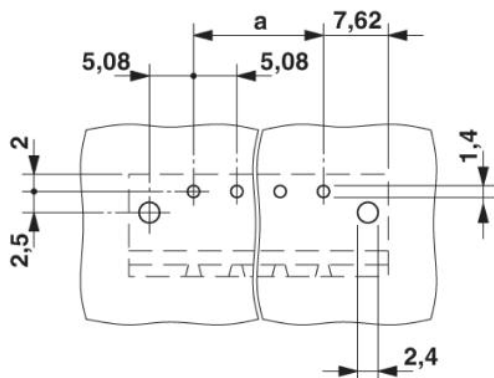

Dimensioned drawing

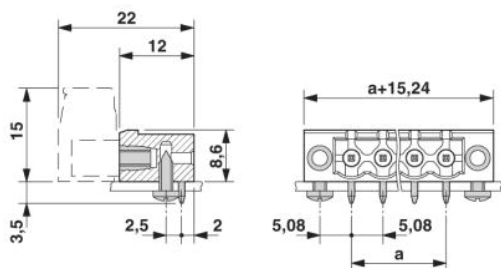

Address

PHOENIX CONTACT Inc., USA
586 Fulling Mill Road
Middletown, PA 17057, USA
Phone (800) 888-7388
Fax (717) 944-1625
<http://www.phoenixcon.com>



© 2010 Phoenix Contact
Technical modifications reserved;