

## CLP0448 Open Frame Power Supply

90 - 265Vac input; 48/54Vdc output; 450W Output Power

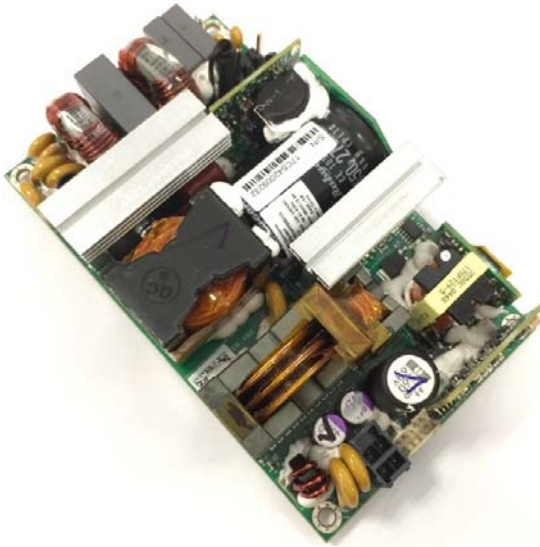

### Applications

- Industrial equipment
- Telecommunications equipment

### Description

In a small 3 x 5 inch footprint, the 48/52Vdc single-output CLP0448 open frame power supply delivers greater than 90 percent typical power efficiency and full load output at 50°C and 1m/s airflow. Protection features include output overcurrent (OCP), overvoltage (OVP), and overtemperature (OTP).

### Features

- Compact size 76.2 mm x 127 mm x 35 mm (3 in x 5 in x 1.38 in) with density of 21.4 W/in<sup>3</sup>
- Universal AC Input Range (90 - 265VAC)
- Output voltage of 48V or 54V (adjustable  $\pm 3V$  around nominal values)
- Standby output of 5V @ 1A
- Standby input power consumption < 0.5W
- Maximum output current of 9.4A@ 48Vout (450W)
- High efficiency (>92% at Full Load, 230VAC in)
- Full load capability at 50°C and 1m/s airflow with derating at higher temperatures or lower airflows
- Capable of  $\geq 340W$  out in sealed enclosure applications with enclosure ambient at 55°C
- Output overcurrent protection (non-latching)
- Overtemperature protection
- Output overvoltage protection
- Minimum of 11ms of holdup time at 450W out
- Parallelable with output current sharing
- Active power factor corrected input
- Conducted EMI - meets CISPR22 (EN55022) and FCC Class B requirements
- Meets IEC61000-4-5, Level 4 (2kV/4kV)
- Isolation levels meet POE Standards (IEEE 602.3af)
- Compliant to RoHS EU Directive 2002/95/EC
- UL and cUL approved to UL/CSA60950-1, TUV (EN60950-1), CE Mark (for LVD) and CB Report available
- ISO\*\* 9001 and ISO 14001 certified manufacturing facilities

\* UL is a registered trademark of Underwriters Laboratories, Inc.

† CSA is a registered trademark of Canadian Standards Association.

‡ VDE is a trademark of Verband Deutscher Elektrotechniker e.V.

\*\* ISO is a registered trademark of the International Organization of Standards

## CLP0448 Open Frame Power Supply

### 90 - 265Vac input; 48/54Vdc output; 450W Output Power

#### Absolute Maximum Ratings

Stresses in excess of the absolute maximum ratings can cause permanent damage to the device. These are absolute stress ratings only, functional operation of the device is not implied at these or any other conditions in excess of those given in the operations sections of the data sheet. Exposure to absolute maximum ratings for extended periods can adversely affect the device reliability.

Parameter	Device	Min	Max	Unit
Input Voltage - Continuous	All	90	265	Vac
For up to 10 seconds	All	90	275	Vac
Operating Ambient Temperature (see Thermal Considerations section)	All	-40	85	°C
Storage Temperature	All	-40	85	°C
Humidity (non-condensing)	All	5	95	%
Altitude	All		5000	m
Isolation Voltage - Input to output	All		3000	Vac
Input to safety ground	All		1500	Vac
Outputs to safety ground (POE compliant)	All		2250	Vdc

#### Electrical Specifications

Note: For cold starts <math>\leq -20\text{C}</math>, unit will meet all specification after a 20minute warm up period with minimum 50% loading.

Parameter	Device	Min	Typ	Max	Unit
Operating Input Voltage	All	90	115/230	265	Vac
Input Source Frequency	All	47	50/60	63	Hz
Input Current ( $V_{IN} = 90\text{Vac}$ )	All			7A	$A_{RMS}$
Input Power Factor (230Vac, Full Load)	All	0.95			
Inrush Transient Current ( $V_{IN} = 265\text{Vac}$ , $T_{amb} = 25\text{°C}$ )	All			60	A Peak
Leakage Current to earth ground ( $V_{IN} = 265\text{Vac}$ )	All			3.5	mA
Output Voltage Setpoint	All		48/54		Vdc
Output Voltage Tolerance (due to set point, temperature variations, load and line regulation)	All	-2		2	%
Output Voltage Adjustment Range	48V out version	46	48	51	Vdc
	54V out version	51	54	57	Vdc
Output Remote Sense Range	All			1	Vdc
Output Load Regulation	All			1	%Vout
Output Line Regulation	All			0.5	%Vout
Output Ripple and Noise - measured with 0.1 $\mu\text{F}$ ceramic capacitor in parallel with 470 $\mu\text{F}$ electrolytic capacitor Peak-to-peak (20MHz Bandwidth)	All			500	mV p-p
Dynamic Load Response - 50% to 100% load transient, 1A/ $\mu\text{s}$ slew rate	All			5%	%
Output voltage deviation	All			500	$\mu\text{s}$
Settling Time	All				
Output Current	48V out version	0		9.4	Adc
	54V out version	0		8.3	Adc
Output Current Limit Inception	All	110		145	% $I_{O,max}$
Maximum Output Capacitance	All			5000	$\mu\text{F}$
Standby Output Voltage	All		5		Vdc
Standby Output Current	All			1	Adc
Efficiency: $V_{IN} = 230\text{Vac}$ , 20% load	All	87.5			%
50% load	All	92.0			%
100% load	All	88.0			%
$V_{IN} = 115\text{Vac}$ , 20% load	All	87.0			%
50% load	All	90.0			%
100% load	All	87.0			%

## CLP0448 Open Frame Power Supply

90 - 265Vac input; 48/54Vdc output; 450W Output Power

Parameter	Device	Min	Typ	Max	Unit
Holdup Time <sup>1</sup> - $V_{IN} = 115V_{ac}$ , 450W load	All	11			ms
$V_{IN} = 230V_{ac}$ , 450W load	All	11			ms
Input Power Consumption in Standby Mode (main output off, 0.2W load on standby output)	All			0.5	W

### General Specifications

Parameter	Device	Symbol	Typ.	Unit
Calculated Reliability based on Telcordia SR-332 Issue 2: Method 1 Case 3 ( $V_{IN}=230V_{ac}$ , $I_o = 37.5A$ , $T_A = 40^{\circ}C$ , airflow 200LFM, 90% confidence)	All	MTBF	>750,000	Hours
Weight	All		388 13.7	g oz.

### Feature Specifications

Parameter	Device	Min	Typ	Max	Unit
On/Off Signal Interface – signal referenced to GND	All				
Logic Low (Power Supply ON)	All				
Input Low Current	All			7	mA
Input Low Voltage	All			1	V
Logic High (Power Supply OFF)	All				
Input High Current	All			600	$\mu A$
Input Voltage	All	2.5		5.5	V
Delay from ON/OFF being enabled to start of output voltage rise	All			200	ms
Output Voltage Rise Time (from 10 to 90% of final value)	All		20		ms
Delay from Input being applied to all outputs being in regulation	All			800	ms
Output Overvoltage Protection (48V version)	All	55.2		64	Vdc
Output Overvoltage Protection (54V version)	All	59		64	Vdc
Input Undervoltage lockout <sup>2</sup>					
Turn-on Threshold (100% load)	All		87.5		Vac
Turn-off Threshold (100% load)	All		79		Vac
DC OK – open collector, High when output available					
Sink Current	All			4	mA
Maximum Collector Voltage	All			12	V

<sup>1</sup> Holdup time may be lower at cold temperatures

<sup>2</sup> Undervoltage lockout threshold may vary with output load current level – decreasing as load goes lower

## CLP0448 Open Frame Power Supply

90 - 265Vac input; 48/54Vdc output; 450W Output Power

## Environmental Specifications

Parameter	Device	Specification/Test
Radiated Emissions <sup>3</sup>	All	CISPR22 Class B with 3dB margin
Conducted Emissions	All	CISPR22 Class B with 6dB margin
ESD	All	IEC61000-4-2, Level 3
Radiated Susceptibility <sup>4</sup>	All	IEC61000-4-3, Level 3
Electrical Fast Transient Common Mode	All	IEC61000-4-4, Level 3
Surge Immunity	All	IEC61000-4-5, Level 4
Conducted RF Immunity	All	IEC61000-4-6, Level 3
Input Voltage Dips	All	Output stays within regulation for either ½ cycle interruption or 25% dip from nominal line for 1 second
Input Harmonics	All	IEC61000-3-2
Shock and Vibration	All	Per IPC-9592B, Class II

## Safety Specifications

Parameter	Device	Specification
Dielectric Withstand Voltage (between input and output)	All	Minimum of 4,250Vdc for 1 minute
Insulation Resistance (between input and output)	All	Minimum of 5 MΩ
Safety Standards	All	Class 1, IEC60950, EN60950, with the following deviations: Nemko, UL 60950 (Recognized Component), cUL (Canadian Approval by UL)

---

<sup>3</sup> Shall meet when tested in a suitable enclosure

<sup>4</sup> Shall meet when tested in a suitable enclosure

# CLP0448 Open Frame Power Supply

90 - 265Vac input; 48/54Vdc output; 450W Output Power

## Characteristic Curves

The following figures provide typical characteristics for the CLP0448 power supply

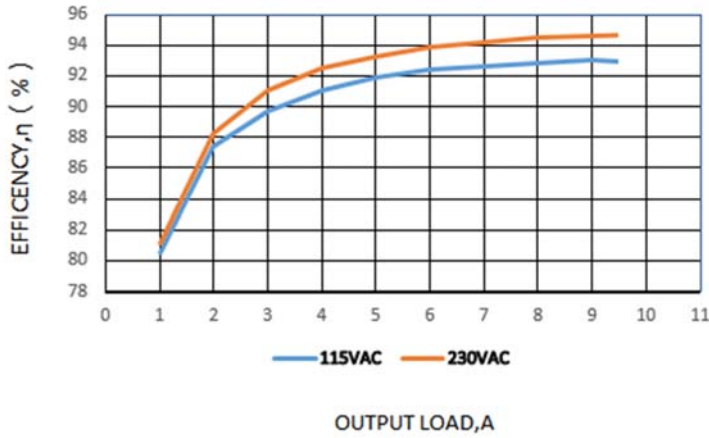

Figure 1. Power Supply Efficiency versus Output Current

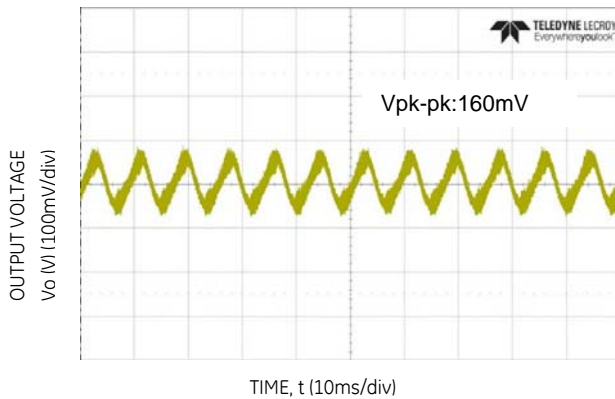

Figure 2. Typical output ripple and noise ( $V_{IN} = 230V_{ac}$ , 100% load).

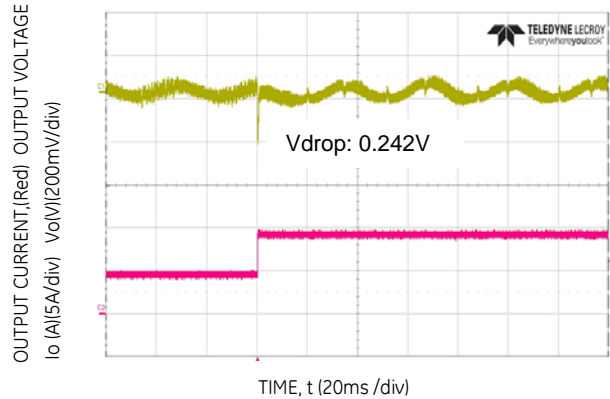

Figure 3. Transient Response to Dynamic Load change from 50% to 100% at  $V_{in} = 230V_{ac}$ .

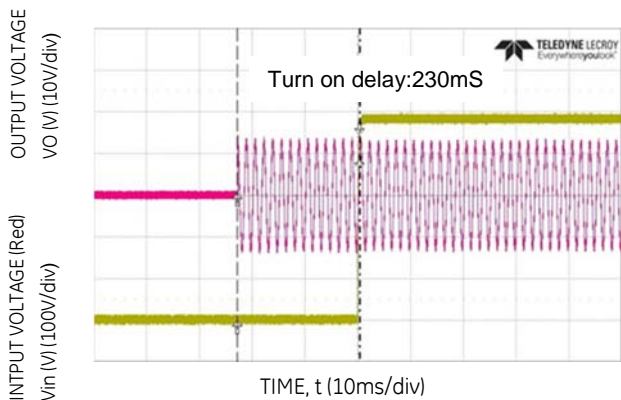

Figure 4. Typical Start-up ( $V_{IN} = 90V_{ac}$ , Full Load).

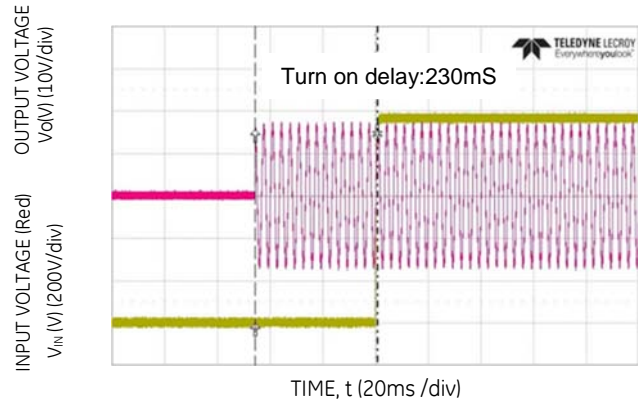

Figure 5. Typical Start-up ( $V_{IN} = 230V_{ac}$ , Full load).

# CLP0448 Open Frame Power Supply

90 - 265Vac input; 48/54Vdc output; 450W Output Power

## Characteristic Curves (cont.)

The following figures provide typical characteristics for the CLP0448 power supply

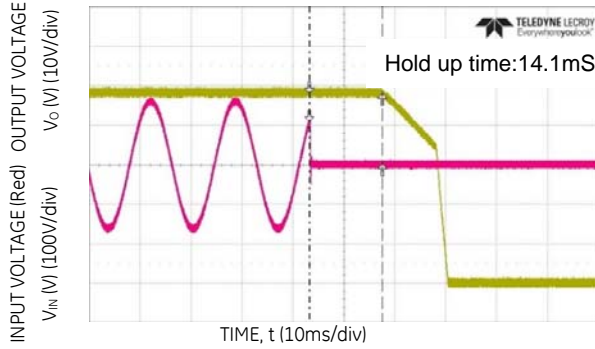

Figure 6. Typical Hold-up waveforms ( $V_{IN} = 115V$ , 100% Load).

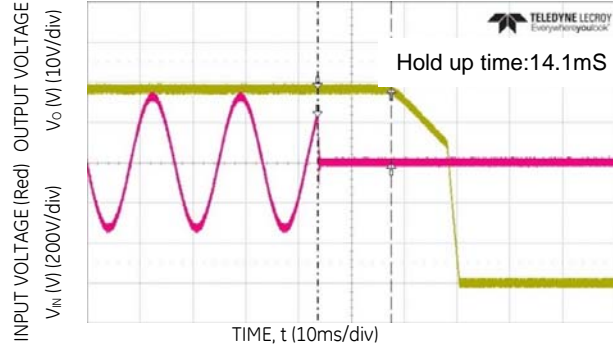
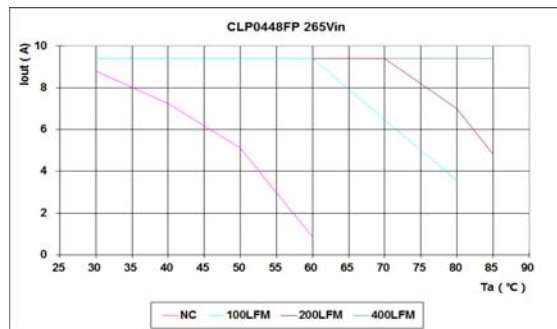
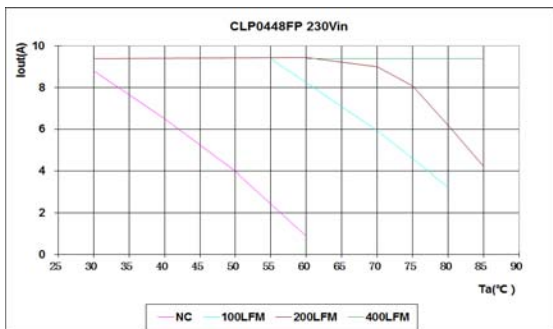
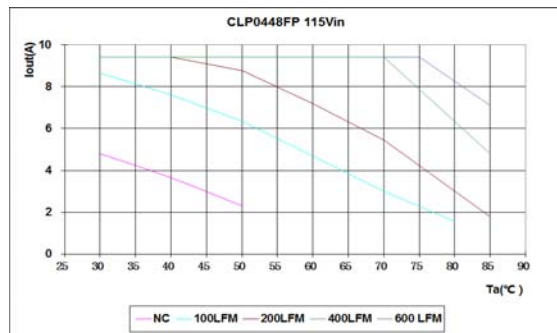
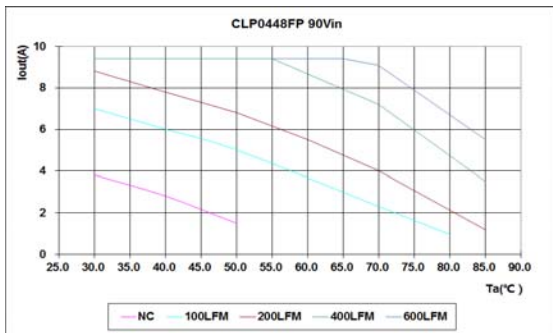
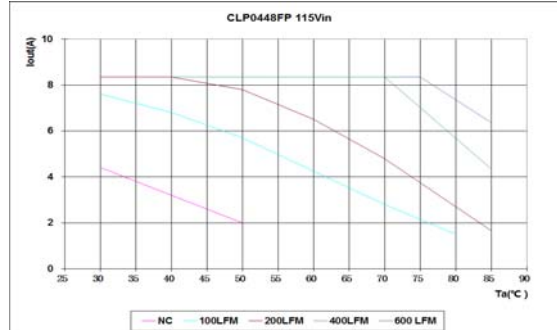
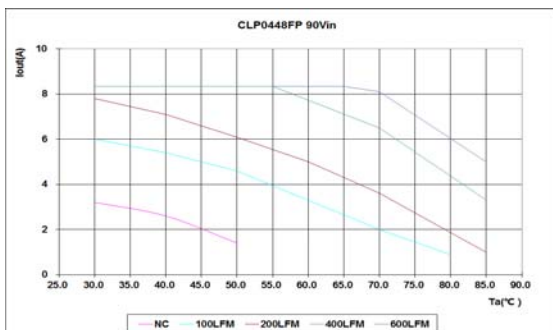

Figure 7. Typical Hold-up waveforms ( $V_{IN} = 230V$ , 100% load).

### Z01 Derating Curves(Airflow Application)



### Z02 Derating Curves(Airflow Application)



CLP0448 Open Frame Power Supply  
 90 - 265Vac input; 48/54Vdc output; 450W Output Power

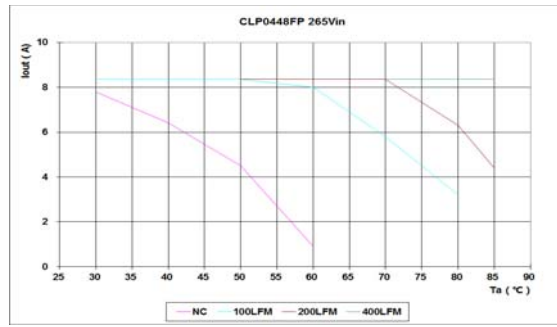
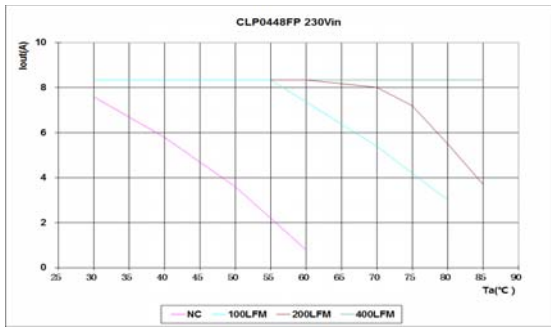

Z01 Derating Curves(Enclosure Application)

Z02 Derating Curves(Enclosure Application)

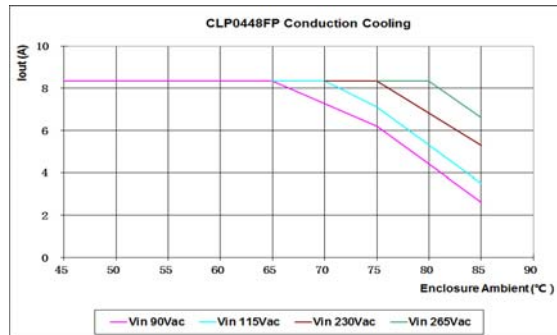
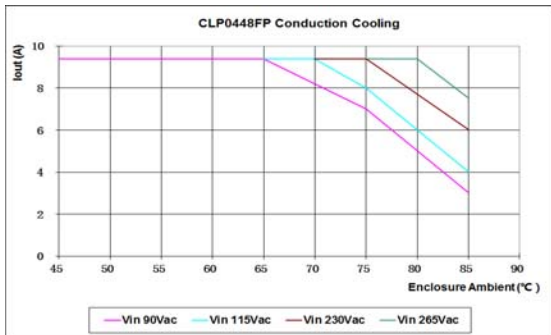

Note: The load is not inside the enclosure when do above enclosure application power derating curves test.

## CLP0448 Open Frame Power Supply

90 - 265Vac input; 48/54Vdc output; 450W Output Power

### Safety Considerations

The CLP0448 power supply is intended for inclusion in other equipment and the installer must ensure that it is in compliance with all the requirements of the end application. This product is only for inclusion by professional installers within other equipment and must not be operated as a stand-alone product. The power supply meet Class 1, IEC60950, EN60950, with the following deviations: Nemko. UL 60950 (Recognized Component) C-UL (Canadian Approval by UL).

### Feature Descriptions

#### Standby Power Supply

A standby output of 5V in the CLP0448 power supply, will come on when AC input in the operating range is applied. 5V standby power is not isolated with main output. 5V output is no output oring.

#### Remote On/Off

The CLP0448 power supply feature a TTL-compatible On/Off control input. The power supply turns ON when the On/Off input goes low, and turns OFF when the input goes high. Note that if the On/Off pin is left unconnected, the power supply main output remain **ON**.

#### Output Voltage Adjustment

The output voltage can be capable of being adjusted between 47V and 53V using a potentiometer on the power.

#### Remote Sense

The power supply have both positive and negative remote sense connections that can be connected to the positive and negative rails of the main output near the load. The power supply can operate without the remote sense connections being made. Don't use this function when in units parallel working mode.

#### Overcurrent Protection

To provide protection in a fault condition (output overload), the power supply is equipped with internal current-limiting circuitry and can endure current limiting continuously. At the point of current-limit inception, the unit enters hiccup mode. The power supply operates normally once the output current is brought back into its specified range.

#### Overvoltage Protection

Overvoltage protection is a feature of the CLP0448 power supply that protects both the load and the power supply from an output overvoltage condition. When an overvoltage occurs, the power supply shuts down and latches off until the overvoltage condition is removed. It is necessary to recycle the input to restart the power supply when this protection is activated.

### Overtemperature Protection

The CLP0448 also features overtemperature protection in order to provide additional protection in a fault condition. The power supply is equipped with a thermal shutdown circuit which detects excessive internal temperatures and shuts the unit down. Once the power supply goes into overtemperature shutdown, it will cool before attempting to restart. The overtemperature protection circuit will typically kick in when the unit is operated at 450W output with an ambient temperature of 66°C and 1m/s (200LFM) airflow at 180Vac.

### Input Undervoltage Lockout

At input voltages below the input undervoltage lockout limit, power supply operation will be disabled. The power supply will begin to operate at an input voltage above the undervoltage lockout turn-on threshold

### DC OK

The CLP0448 provide a DC OK signal that indicates when the output has come up and is in regulation. This is an open-collector type signal that goes high when the output is available and within regulation. DC\_ok refer to 5V\_return, DC OK signal is independent each other when parallel working.

### Power Good LED

A green LED on board the power supply will illuminate when the main output voltage is above 45V.

### Paralleling with Active Output Current Sharing (option)

This power supply can be capable of parallel operation with active output current sharing in all options that have this feature. Paralleling of up to four power supplies can be supported. Paralleling will be accomplished by connecting the Current Share signals of multiple power supplies together. At load current levels above 20%, the output currents of multiple power supplies will be within  $\pm 5\%$  of the full load value. 5V Standby Return should be connected together when using remote on/off function for paralleled units. Please don't use remote sense function when parallel working.



## CLP0448 Open Frame Power Supply

90 - 265Vac input; 48/54Vdc output; 450W Output Power

### Thermal Considerations

The power supply can be operated in a variety of thermal environments; however sufficient cooling should be provided to ensure reliable operation.

Considerations include ambient temperature, airflow, power supply dissipation and the need for increased reliability. A reduction in the operating temperature of the power supply will result in increased reliability. The power supply can be capable of delivering full output power of 450W at an ambient temperature of at least 50°C and 1m/s (200LFM) of airflow. The output power can be derated at higher output temperatures and lower airflow, but can at least deliver 300W at 70°C and 1m/s (200LFM) of airflow.

In addition, in conduction-cooled applications with a suitable enclosure, the power supply can be capable of delivering 340W when the enclosure ambient temperature is 55°C, with operation at 90VAC in.

### Operation in a Sealed Enclosure

The CLP0448 power supply can also be operated in a sealed enclosure or in an environment where cooling is primarily via conduction. Figure 10 shows an arrangement where thermally conductive pads are used to transfer heat from the top and bottom of the power supply into the enclosure. Under such conditions, the power supply is capable of reduced power operation as shown in page 7 [Derating Curves\(Enclosure Application\)](#).

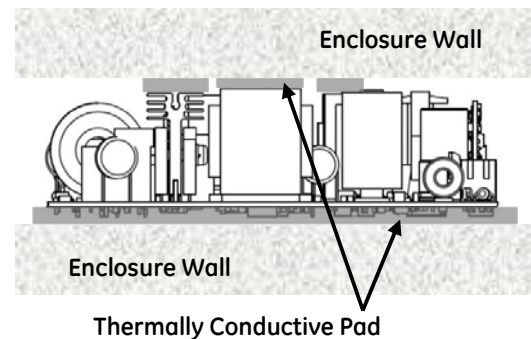
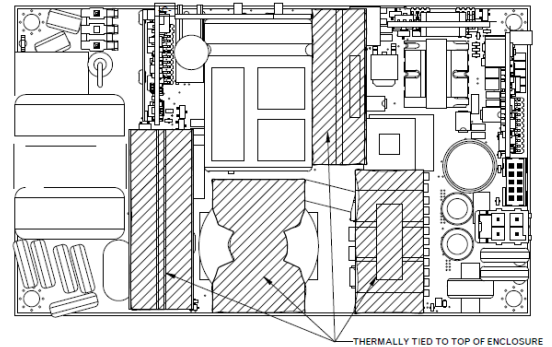

**Fig. 10. Example arrangement of the CLP0448 for sealed enclosure applications.**

Thermal conductivity should be 3.0 W/m-K for thermal pad application and 1kV+ isolation, example:

**Thermal gap pad:**

[http://www.bergquistcompany.com/pdfs/dataSheets/PDS\\_GP\\_HC3\\_0714%20v7.pdf](http://www.bergquistcompany.com/pdfs/dataSheets/PDS_GP_HC3_0714%20v7.pdf)

**Thermal gap pad:**

<https://www.lairdtech.com/products/tputty-502>

CLP0448 Open Frame Power Supply  
 90 - 265Vac input; 48/54Vdc output; 450W Output Power

Mechanical Outline

TOP VIEW

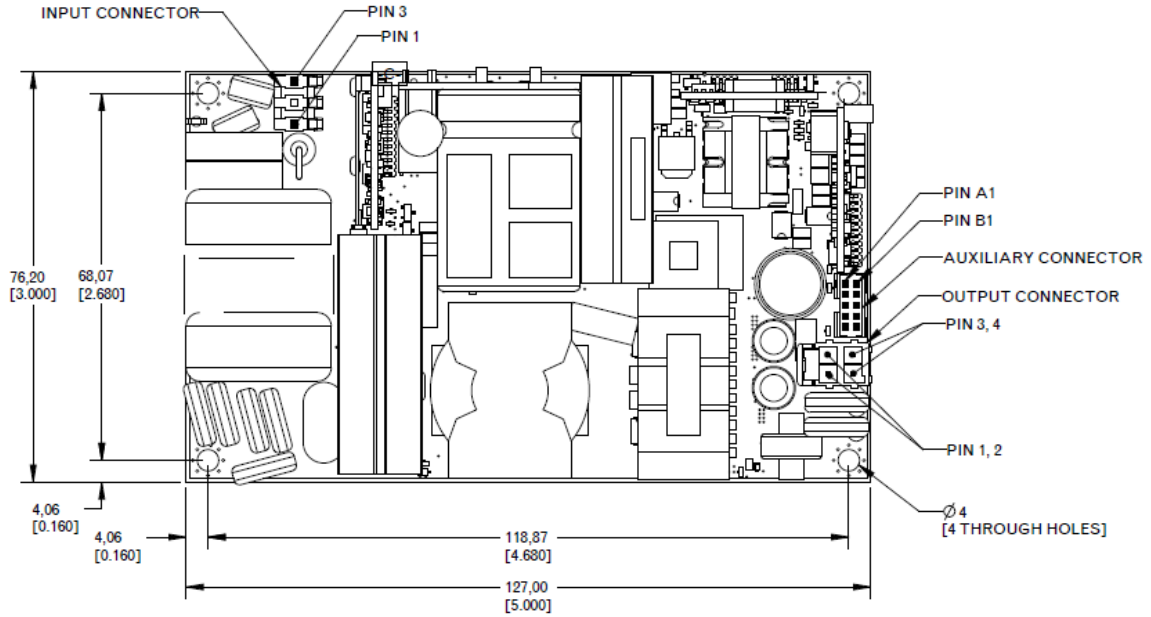

SIDE VIEW

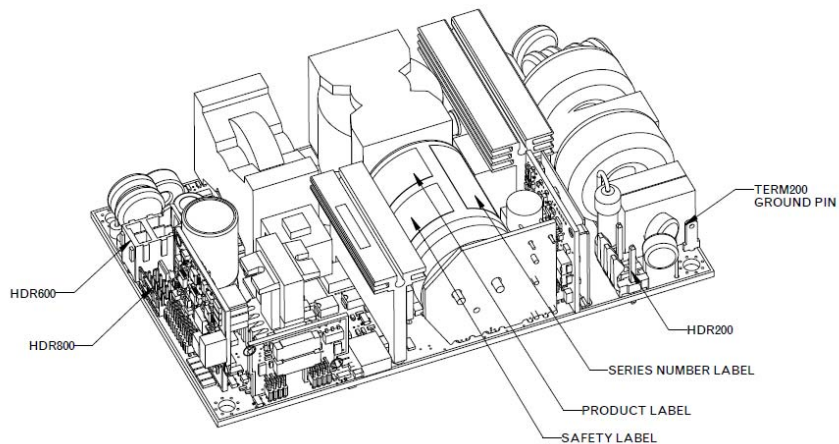
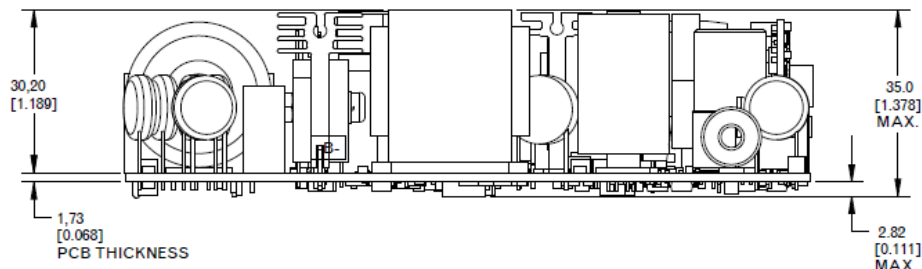

# CLP0448 Open Frame Power Supply

90 - 265Vac input; 48/54Vdc output; 450W Output Power

## Metal Cover Accessory(Optional)

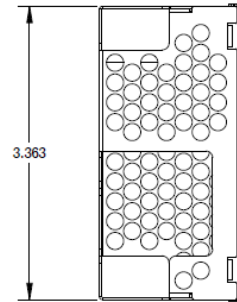
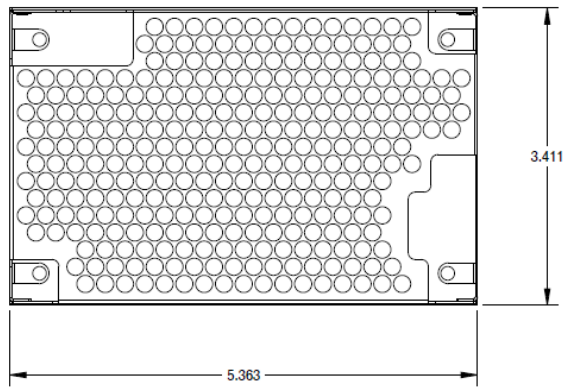
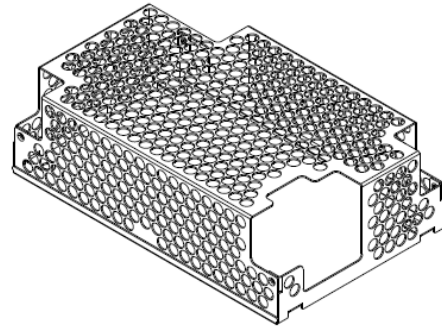
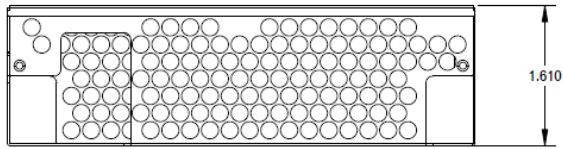

## CLP0448 Open Frame Power Supply

90 - 265Vac input; 48/54Vdc output; 450W Output Power

### Connector Information

Connector	Connector on Power Supply	Mating Connector
AC Input Connector (HDR200)	Molex 41671-3473 or equivalent	Molex 09-50-8031 or equivalent
DC Output Connector (HDR600)	Molex 172298-1204 or equivalent	Molex 1722581104 or equivalent
Auxiliary Connector (HDR800)	FCI 98414-G04-10ULF or equivalent	FCI 90311-010LF or equivalent
Ground Pin (TERM200)	TE P/N: 63756-1	TE 110series Receptacles (eg:63093-1 18~14AWG) or equivalent

### Pinout Information

Input Connector (HDR200)		DC Output Connector (HDR600)		Auxiliary Connector (HDR800)			
PIN 1	Line	PINS 1	VOUT +	PIN A1	5V Standby	PIN B1	PARALLEL
PIN 2	NC (Removed)	PINS 2	VOUT +	PIN A2	5V Standby	PIN B2	5V Standby Return
PIN 3	Neutral	PINS 3	VOUT - (Return)	PIN A3	NC	PIN B3	5V Standby Return
		PINS4	VOUT - (Return)	PIN A4	REMOTE SENSE +	PIN B4	DC_OK
				PIN A5	REMOTE SENSE -	PIN B5	ON/OFF

## CLP0448 Open Frame Power Supply

90 - 265Vac input; 48/54Vdc output; 450W Output Power

### Ordering Information

Please contact your GE Sales Representative for pricing, availability and optional features.

**Table 1. Device Codes**

Device Code	Input Voltage Range	Output Voltage	Output Current	On/Off Control	Standby Supply	Temperature Range
CLP0448FPXXXZ01A	90 - 265Vac	48Vdc	9.4A	Negative Logic	5V @ 1A	-40 to 85°C
CLP0448FPXXXZ02A	90 - 265Vac	54Vdc	8.3A	Negative Logic	5V @ 1A	-40 to 85°C
CLP04XXCVRXXZ01A	Metal cover accessory					

## Contact Us

For more information, call us at

USA/Canada:

**+1 877 546 3243**, or +1 972 244 9288

Asia-Pacific:

**+86.021.54279977\*808**

Europe, Middle-East and Africa:

**+49.89.878067-280**

[www.gecriticalpower.com](http://www.gecriticalpower.com)



GE Critical Power reserves the right to make changes to the product(s) or information contained herein without notice, and no liability is assumed as a result of their use or application. No rights under any patent accompany the sale of any such product(s) or information.