



# MLSE-0300A2NP0

MLS

MAGNETIC LINE GUIDANCE SENSORS

**SICK**  
Sensor Intelligence.



### Ordering information

Type	Part no.
MLSE-0300A2NP0	1090688

Other models and accessories → [www.sick.com/MLS](http://www.sick.com/MLS)



### Detailed technical data

#### Features

<b>Detection range typ.</b>	300 mm
<b>Operating height</b>	10 mm ... 50 mm
<b>Electrical wiring</b>	DC 4-wire
<b>Teach-in</b>	✓
<b>Enclosure rating</b>	IP65, IP67, IP68 <sup>1)</sup>

<sup>1)</sup> According to EN 60529.

#### Mechanics/electronics

<b>Supply voltage</b>	9 V DC ... 30 V DC <sup>1)</sup>
<b>Terminal resistor</b>	No internal terminator
<b>Protection class</b>	III
<b>Power consumption</b>	600 mW
<b>Resolution, typ.</b>	1 mm
<b>Repeat accuracy, typ.</b>	1 mm
<b>Update rate</b>	100 Hz
<b>Reverse polarity protection</b>	✓
<b>Short-circuit protection</b>	✓
<b>Ambient operating temperature</b>	-20 °C ... +70 °C
<b>Shock and vibration resistance</b>	30 g, 11 ms/10 Hz ... 55 Hz, 1 mm
<b>EMC</b>	According to EN 60947-5-2
<b>Housing material</b>	Metal, Aluminum, Plastic
<b>Connection type</b>	Cable with M8 male connector, 4-pin, 0.3 m <sup>2)</sup>
<b>Cable material</b>	PUR
<b>Conductor cross-section</b>	0.08 mm <sup>2</sup>
<b>UL File No.</b>	NRKH.E181493 & NRKH7.E181493

<sup>1)</sup> Reverse-polarity protected, operation in short-circuit protected network: max. 8 A.

<sup>2)</sup> Do not bend below 0 °C.

## Classifications

<b>ECl@ss 5.0</b>	27270104
<b>ECl@ss 5.1.4</b>	27270104
<b>ECl@ss 6.0</b>	27270104
<b>ECl@ss 6.2</b>	27270104
<b>ECl@ss 7.0</b>	27270104
<b>ECl@ss 8.0</b>	27270104
<b>ECl@ss 8.1</b>	27270104
<b>ECl@ss 9.0</b>	27270104
<b>ETIM 5.0</b>	EC002544
<b>ETIM 6.0</b>	EC002544
<b>UNSPSC 16.0901</b>	39122230

## Communication interface

<b>Communication interface</b>	CANopen
--------------------------------	---------

## Connection diagram

cd-396

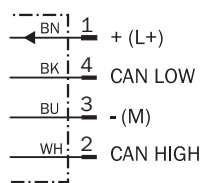

## Dimensional drawing (Dimensions in mm (inch))

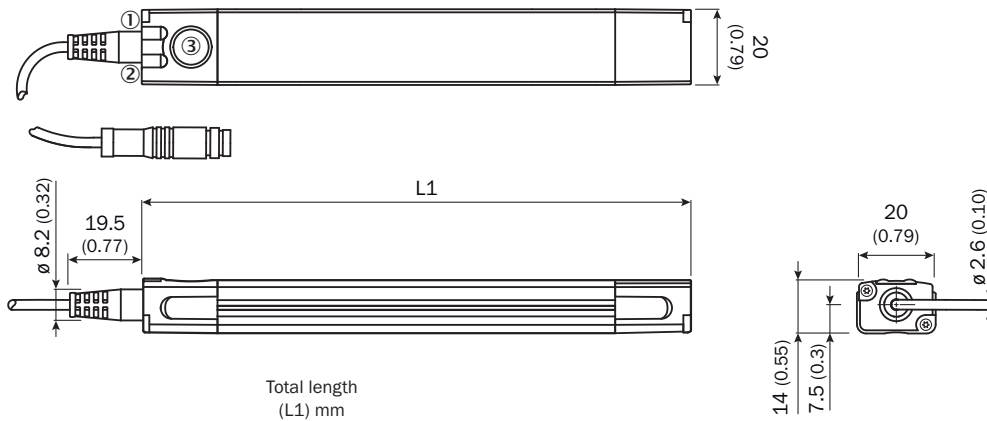









	Total length (L1) mm
<b>MLSE-0200</b>	217
<b>MLSE-0300</b>	325
<b>MLSE-0400</b>	397
<b>MLSE-0500</b>	505
<b>MLSE-0600</b>	613

- ① Function signal indicator 1
- ② Function signal indicator 2
- ③ Teach-Pad

## Recommended accessories

Other models and accessories → [www.sick.com/MLS](http://www.sick.com/MLS)

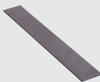
	Brief description	Type	Part no.
<b>Mounting brackets and plates</b>			
	Bracket for low mounting, Stainless steel V2A (bracket/mounting screw), Brass (fixing screw)	BEF-WNLO1MPA	2065973
	Bracket for lateral mounting, Stainless steel V2A (bracket/mounting screw), Brass (fixing screw)	BEF-WNZ01MPA	2065577
<b>Adapters and distributors</b>			
	CAN-USB Adapter to connect MLS with a PC	AKA-NXL1BxB12KX	6067651
	Y-cable to connect MLS to a CAN-USB Adapter and a power supply	YF8U14-011VA3FYDN2	2098412
<b>Plug connectors and cables</b>			
	Head A: female connector, M8, 4-pin, straight, A-coded Head B: Flying leads Cable: Sensor/actuator cable, PUR, halogen-free, unshielded, 2 m	YF8U14-020UA3XLEAX	2094791
	Head A: female connector, M8, 4-pin, straight, A-coded Head B: Flying leads Cable: Sensor/actuator cable, PUR, halogen-free, unshielded, 5 m	YF8U14-050UA3XLEAX	2094792

	<b>Brief description</b>	<b>Type</b>	<b>Part no.</b>
	Head A: female connector, M8, 4-pin, angled, A-coded Head B: Flying leads Cable: Sensor/actuator cable, PUR, halogen-free, unshielded, 2 m	YG8U14-020UA3XLEAX	2095589
	Head A: female connector, M8, 4-pin, angled, A-coded Head B: Flying leads Cable: Sensor/actuator cable, PUR, halogen-free, unshielded, 5 m	YG8U14-050UA3XLEAX	2095590
<b>Magnets</b>			
	Magnetic tape, North is top side, adhesive, width 25 mm, length 50 m	MAGNETIC TAPE	5337613
	Magnetic tape, South is top side, adhesive, width 25 mm, length 50 m	MAGNETIC TAPE	5337614
	Positioning device for magnetic markers (5337613, 5337614) for MLS	TEMPLATE	4097520

## SICK AT A GLANCE

SICK is one of the leading manufacturers of intelligent sensors and sensor solutions for industrial applications. A unique range of products and services creates the perfect basis for controlling processes securely and efficiently, protecting individuals from accidents and preventing damage to the environment.

We have extensive experience in a wide range of industries and understand their processes and requirements. With intelligent sensors, we can deliver exactly what our customers need. In application centers in Europe, Asia and North America, system solutions are tested and optimized in accordance with customer specifications. All this makes us a reliable supplier and development partner.

Comprehensive services complete our offering: SICK LifeTime Services provide support throughout the machine life cycle and ensure safety and productivity.

For us, that is “Sensor Intelligence.”

## WORLDWIDE PRESENCE:

Contacts and other locations –[www.sick.com](http://www.sick.com)