

Tous droits strictement reserves. Reproduction ou communication a des tiers interalle sous quelque forme que ce soit sans autorisation ecrite du proprietaire. Propriete de c FCI. Droits de reproduction FCI.

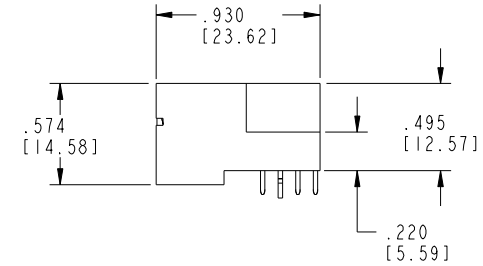

All rights strictly reserved. Reproduction or issue to third parties in any form whatever is not permitted without written authority from the proprietor. Property of FCI. Copyright FCI.

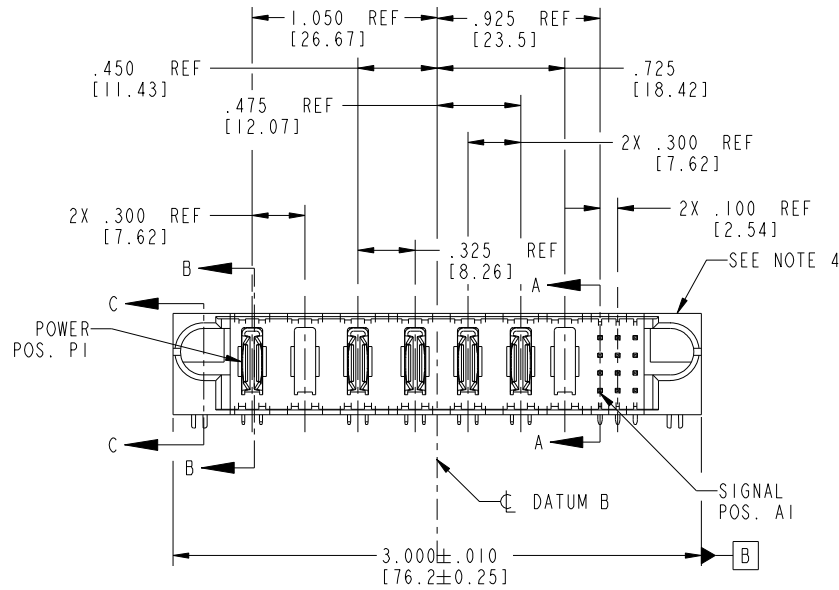
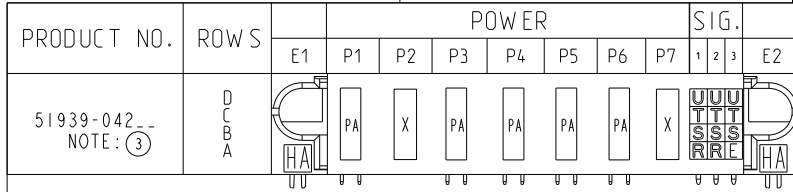

| CODE | DIM "M" MATING LENGTH | CONTACT TYPE |
|------|-----------------------|--------------|
| E | .220 [5.59] | SIGNAL |
| R | .270 [6.86] | SIGNAL |
| S | .270 [6.86] | SIGNAL |
| T | .270 [6.86] | SIGNAL |
| U | .270 [6.86] | SIGNAL |
| PA | N/A [N/A] | POWER |
| HA | N/A [N/A] | HOLD-DOWN |
| X | OMITTED | |

| | | | | | | | | | | | |
|-------------|----------------|-----|----------|------------|-----------------------|---------------------------------------|-------------|----------|---------------------------|------------------------|--------|
| mat'l code | | | | SEE NOTE 2 | | tolerances unless otherwise specified | | CUSTOMER | | www.fciconnect.com | |
| lfr | ecn no. | dr | date | linear | .XX±.01/0.X±0.3 | | COPY | | title | | |
| A | V03-0129 | TAB | 01/30/03 | | .XXX±.005/0.XX±0.13 | | projection | | 3ACP + 4P + 12S | | |
| B | DG05-0206 | SJ | 07/05/05 | angles | .XXX±.002/0.XXX±0.051 | | INCH/MM | | RIGHT ANGLE SOLDER HEADER | | |
| C | DG06-0008 | JMG | 01/07/06 | | 0°±2° | | scale | | product family | | |
| D | DG08-0273 | WD | 12/30/08 | dr | T. BRUNGARD | 01/30/03 | 1:1 | | PwrBlade | | code |
| | | | | enrg | M. MOSTOLLER | 01/30/03 | | | size | | 213 |
| | | | | chr | M. MOSTOLLER | 01/30/03 | | | dwg no | | sheet |
| | | | | appd | M. MOSTOLLER | 01/30/03 | | | A 51939-042 | | 1 of 4 |
| sheet index | revision sheet | D | D | D | D | | | | cage code | | |
| | | 1 | 2 | 3 | 4 | | | | 22526 | | |

Pro/E

cage code 22526

Tous droits strictement réservés. Reproduction ou communication à des tiers interdite sous quelque forme que ce soit sans autorisation écrite du propriétaire. Propriété de c.FCI. Droits de reproduction FCI.

All rights strictly reserved. Reproduction or issue to third parties in any form whatsoever is not permitted without written authority from the proprietor. Property of FCI. Copyright FCI.

PRODUCT NUMBER
51939-042--
NOTE: ③

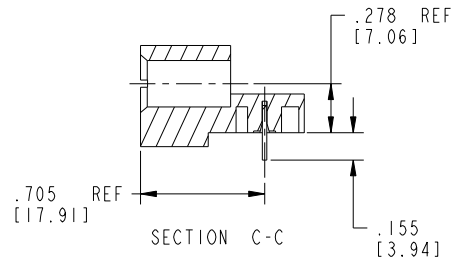
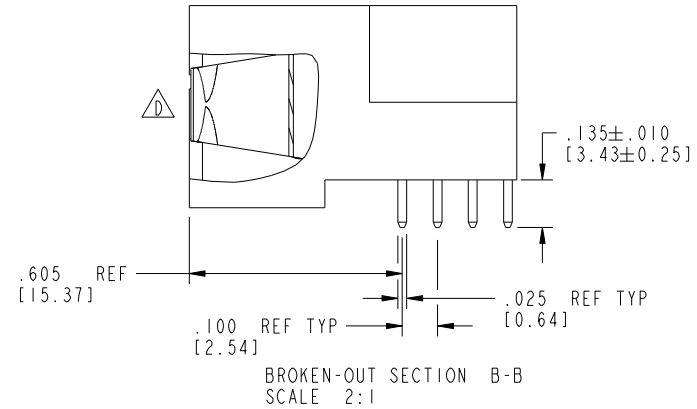
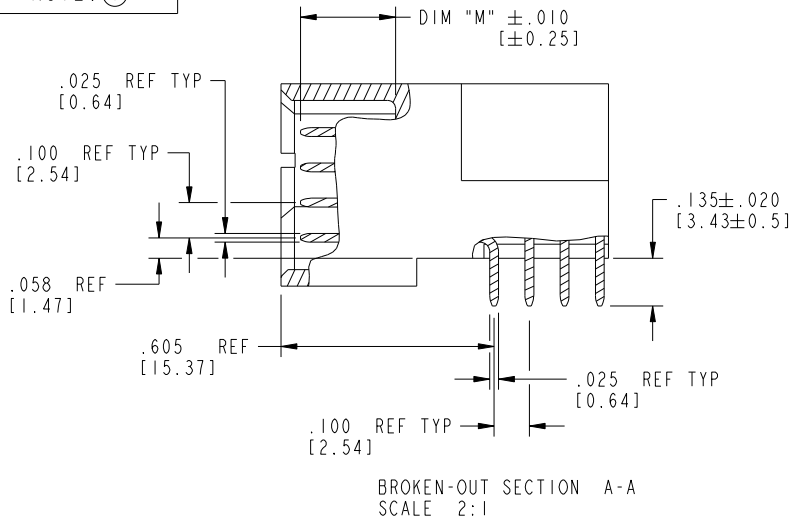

| | | | | | | | | | | | |
|-------------|---------|----------------|------|------------|------------------------|---------------------------------------|--|---------------------------|--|--------------------|--|
| mat'l code | | | | SEE NOTE 2 | | tolerances unless otherwise specified | | CUSTOMER | | FCI | |
| ltr | ecr no. | dr | date | linear | .XX±.01/0.X±0.3 | projection | | COPY | | www.fciconnect.com | |
| D | | | | | .XXX±.005/0.XX±0.13 | INCH/MM | | title | | 3ACP + 4P + 12S | |
| | | | | angles | .XXX±.0020/0.XXX±0.051 | scale | | RIGHT ANGLE SOLDER HEADER | | product family | |
| | | | | dr | 0°±2° | 1:1 | | PwrBlade | | code | |
| | | | | enr | T. BRUNGARD 01/30/03 | A | | size | | 213 | |
| | | | | chr | M. MOSTOLLER 01/30/03 | A | | dwg no | | sheet | |
| | | | | appd | M. MOSTOLLER 01/30/03 | A | | 51939-042 | | 2 of 4 | |
| sheet index | | revision sheet | | | | | | | | | |

cage code 22526

Pro/E

Tous droits strictement réservés. Reproduction ou communication à des tiers interdite sous quelque forme que ce soit sans autorisation écrite du propriétaire. Propriété de c.FCI. Droits de reproduction FCI.



All rights strictly reserved. Reproduction or issue to third parties in any form whatsoever is not permitted without written authority from the proprietor. Property of FCI. Copyright FCI.

PRODUCT NUMBER
51939-042--
NOTE: ③

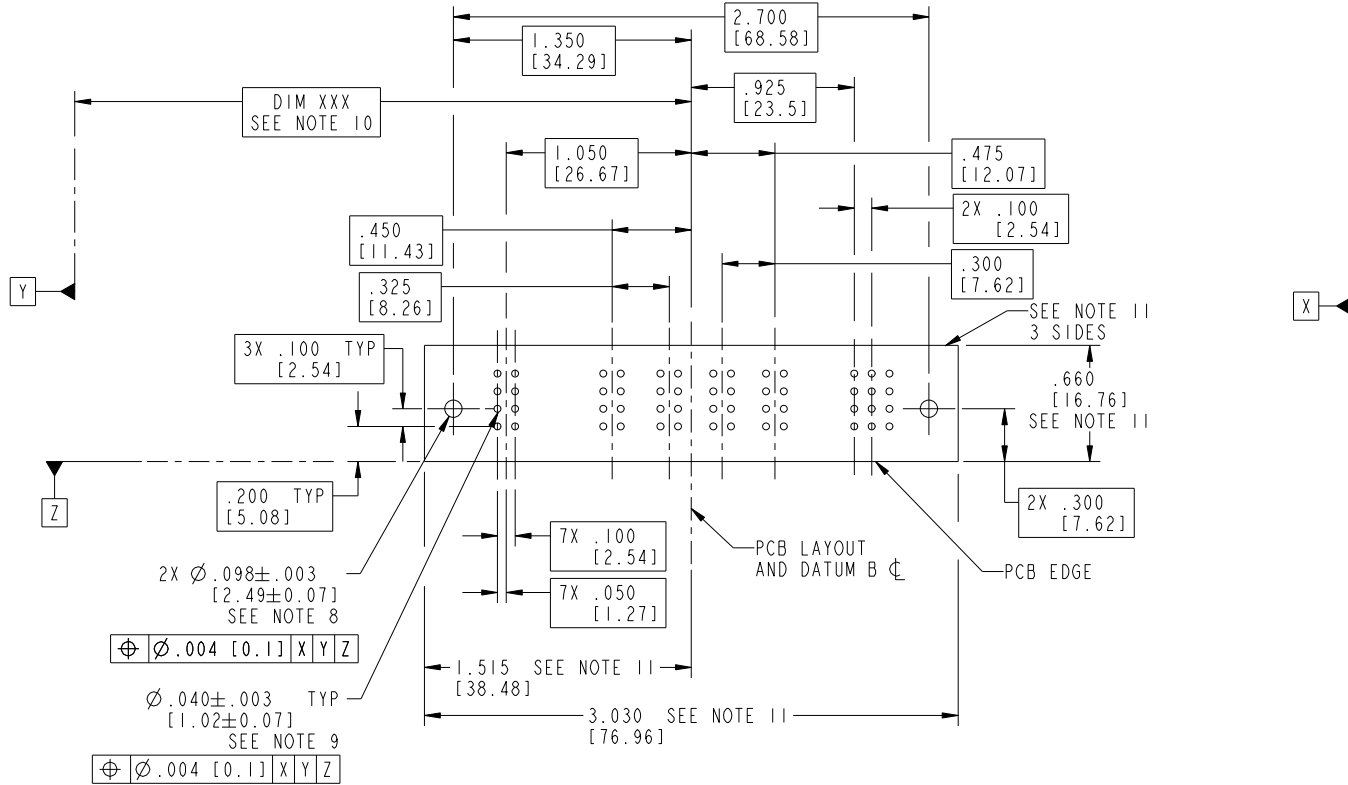

RECOMMENDED PCB LAYOUT

| | | | | | | | | | | | |
|-------------|----------------|----|------|------------|------------------------|---------------------------------------|------------|----------|---------------------------|------------------------|--------|
| mat'l code | | | | SEE NOTE 2 | | tolerances unless otherwise specified | | CUSTOMER | | www.fciconnect.com | |
| lfr | ecn no. | dr | date | linear | .XX±.01/0.X±0.3 | | COPY | | title | | |
| D | | | | | .XXX±.005/0.XX±0.13 | | projection | | 3ACP + 4P + 12S | | |
| | | | | | .XXX±.0020/0.XXX±0.051 | | | | RIGHT ANGLE SOLDER HEADER | | |
| | | | | angles | 0°+2° | | INCH/MM | | product family | | code |
| | | | | dr | T. BRUNGARD 01/30/03 | | scale | | PwrBlade | | 213 |
| | | | | enrg | M. MOSTOLLER 01/30/03 | | 1:1 | | size | | sheet |
| | | | | chr | M. MOSTOLLER 01/30/03 | | A | | dwg no | | 3 of 4 |
| | | | | appd | M. MOSTOLLER 01/30/03 | | | | 51939-042 | | |
| sheet index | revision sheet | | | | | | | | | | |

cage code 22526

Tous droits strictement reserves. Reproduction ou communication a des tiers interdite sous quelque forme que ce soit sans autorisation écrite du propriétaire. Propriete de c FCI. Droits de reproduction FCI.



All rights strictly reserved. Reproduction or issue to third parties in any form whatever is not permitted without written authority from the proprietor. Property of FCI. Copyright FCI.

PRODUCT NUMBER
51939-042--
NOTE: ③

NOTES:

1. DIMENSIONS AND TOLERANCES ARE IN ACCORDANCE WITH ASME Y14.5M, 1994 UNLESS OTHERWISE SPECIFIED.

CONNECTOR NOTES:

2. HOUSING MATERIAL: UL 94 V-0 GLASS FILLED HIGH-TEMP THERMOPLASTIC
POWER CONTACT MATERIAL: COPPER ALLOY
SIGNAL PIN MATERIAL: COPPER ALLOY

③ SEE ITEM 1 & 2 IN PRINT 10064183 FOR PLATING SPEC OF 51939-042 AND 51939-042LF RESPECTIVELY.

4. MANUFACTURER'S NAME, P/N, AND DATE CODE TO APPEAR ON THIS SURFACE.

5. PRODUCT SPECIFICATION GS-12-149.
APPLICATION SPECIFICATION BUS-20-067.

6. PACKAGED IN TRAYS.

PCB NOTES:

7. ALL HOLE DIAMETERS ARE FINISHED HOLE SIZE.

8. MOUNTING HOLES, WHERE APPLICABLE, ARE UNPLATED.

9. $\varnothing .0453 \pm .0010$ [1.151 ± 0.025] DRILLED HOLES PLATED WITH
.0003 [0.008] MIN SnPb OVER .001 [0.03]
TO .003 [0.08] Cu PLATING TO ACHIEVE
 $\varnothing .040 \pm .003$ [1.02 ± .07] HOLE.

10. "DIM XXX" TO BE DETERMINED BY THE CUSTOMER.

11. CONNECTOR KEEP-OUT ZONE.

12. A/D SYMBOL WILL BE NEXT TO ANY DIMENSION, VIEW, OR NOTE WHICH HAS BEEN MODIFIED WITH THE CURRENT DRAWING REVISION.

| | | | | | | | | | | | | | |
|-------------|----------------|----|------|------------|------------------------|---------------------------------------|---------|----------|------------|----------------|-----------|--------------------|--|
| mat'l code | | | | SEE NOTE 2 | | tolerances unless otherwise specified | | CUSTOMER | | FCI | | www.fciconnect.com | |
| ltr | ecr no. | dr | date | linear | .XX±.01/0.X±0.3 | | COPY | | projection | title | | | 3ACP + 4P + 12S RIGHT ANGLE SOLDER HEADER |
| D | | | | | .XXX±.005/0.XX±0.13 | | INCH/MM | | | product family | | | |
| | | | | angles | .XXX±.0020/0.XXX±0.051 | | 1:1 | | PwrBlade | | 213 | sheet | |
| | | | | | 0°+2° | | scale | | size | | 4 of 4 | | |
| | | | | dr | T. BRUNGARD | 01/30/03 | | | A | | 51939-042 | | |
| | | | | enrg | M. MOSTOLLER | 01/30/03 | | | | | | | |
| | | | | chr | M. MOSTOLLER | 01/30/03 | | | | | | | |
| | | | | appd | M. MOSTOLLER | 01/30/03 | | | | | | | |
| sheet index | revision sheet | | | | | | | | | | | | |

cage code 22526

Pro/E