

LTM4650-1

High Efficiency, Single 50A or Dual 25A Step-Down Power  $\mu$ Module Regulator

**DESCRIPTION**

Demonstration circuit DC2378A-B features the LTM<sup>®</sup>4650EY-1, the high efficiency, high density, dual 25A, single 50A, switch mode step-down power module regulator. The input voltage is from 4.5V to 15V. The output voltage is programmable from 0.6V to 1.8V. DC2378A-B can deliver 25A maximum current from each channel. As explained in the data sheet, output current derating is necessary for certain  $V_{IN}$ ,  $V_{OUT}$ , and thermal conditions. The board operates in continuous conduction mode in heavy load conditions. For high efficiency at low load currents, the MODE jumper (JP1) selects pulse-skipping mode for noise sensitive applications or Burst Mode<sup>®</sup> operation in less noise sensitive applications. Two outputs can be connected in parallel for a single 50A output solution with optional jumper resistors. The board allows the user to program

how its output ramps up and down through the TRACK/SS pin. The output can be set up to either coincidentally or ratiometrically track with another supply's output. Remote output voltage sensing is available for improved output voltage regulation at the load point. These features and the availability of the LTM4650EY-1 in a compact 15mm  $\times$  15mm  $\times$  5.01mm BGA package make it ideal for use in many high density point-of-load regulation applications. The LTM4650-1 data sheet must be read in conjunction with this demo manual for working on or modifying the demo circuit DC2378A-B.

**Design files for this circuit board are available at <http://www.linear.com/demo/DC2378A-B>**

LT, LT, LTC, LTM, Linear Technology, the Linear logo and Burst Mode are registered trademarks of Linear Technology Corporation. All other trademarks are the property of their respective owners.

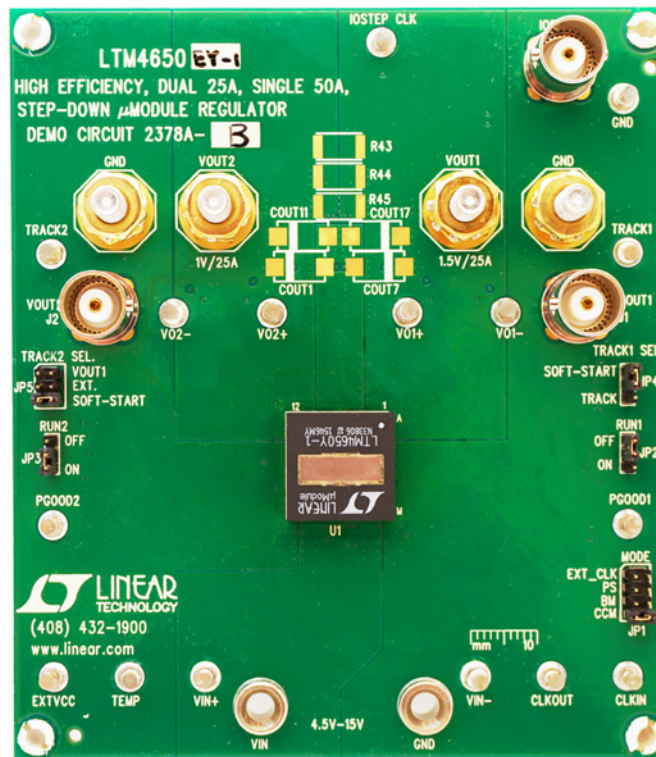

Figure 1. LTM4650-1/DC2378A-B Demo Board

# DEMO MANUAL DC2378A-B

## PERFORMANCE SUMMARY Specifications are at T<sub>A</sub> = 25°C

PARAMETER	CONDITIONS	MIN	TYP	MAX	UNITS
Input Voltage Range		4.5		15	V
Output Voltage V <sub>OUT1</sub>	V <sub>IN</sub> = 4.5V ~ 15V, I <sub>OUT1</sub> = 0A ~ 25A, JP1: CCM		1.5 ±1.5%		V
Output Voltage V <sub>OUT2</sub>	V <sub>IN</sub> = 4.5V ~ 15V, I <sub>OUT2</sub> = 0A ~ 25A, JP1: CCM		1 ±1.5%		V
Per-Channel Maximum Continuous Output Current	Derating Is Necessary for Certain V <sub>IN</sub> , V <sub>OUT</sub> and Thermal Conditions, See Data Sheet for Detail.		25 (Per-Channel)		A
Default Operating Frequency			500		kHz
Resistor Programmable Frequency Range		250		780	kHz
External Clock Sync. Frequency Range		400		780	kHz
Efficiency of Channel 1	V <sub>IN</sub> = 12V, V <sub>OUT1</sub> = 1.5V, I <sub>OUT1</sub> = 25A, f <sub>SW</sub> = 500kHz		88.8 See Figure 4		%
Efficiency of Channel 2	V <sub>IN</sub> = 12V, V <sub>OUT2</sub> = 1V, I <sub>OUT2</sub> = 25A, f <sub>SW</sub> = 500kHz		86.5 See Figure 5		%
Load Transient of Channel 1	V <sub>IN</sub> = 12V, V <sub>OUT1</sub> = 1.5V, I <sub>STEP</sub> = 12.5A ~ 18.75A		See Figure 6		
Load Transient of Channel 2	V <sub>IN</sub> = 12V, V <sub>OUT2</sub> = 1V, I <sub>STEP</sub> = 12.5A ~ 18.75A		See Figure 7		

## QUICK START PROCEDURE

Demonstration circuit DC2378A-B is easy to set up to evaluate the performance of the LTM4650EY-1. Please refer to Figure 2 for proper measurement setup and follow the procedure below:

- Place jumpers in the following positions for a typical application:

JP1	JP2	JP3	JP4	JP5
MODE	RUN1	RUN2	TRACK1 SEL.	TRACK2 SEL.
CCM	ON	ON	SOFT-START	SOFT-START

- With power off, connect the input power supply, load and meters as shown in Figure 2. Preset the load to 0A and V<sub>IN</sub> supply to 12V.
- Turn on the power supply at the input. The output voltage in channel 1 should be 1.5V ±1.5% (1.4775V ~ 1.5225V) and the output voltage in channel 2 should be 1V ±1.5% (0.985V ~ 1.015V).
- Once the proper output voltage is established, adjust the load within the operating range and observe the output voltage regulation, output voltage ripple, efficiency and other parameters. Output ripple should be measured at J1 and J2 with BNC cables. 50Ω termination should be set on the oscilloscope or BNC cables.
- (Optional) For optional load transient test, apply an adjustable pulse signal between IOSTEP CLK and GND test point. Pulse amplitude (3V ~ 3.5V) sets the load step current amplitude. The output transient current can be monitored at the BNC connector J3 (10mV/A). The pulse signal should have very small duty cycle (< 1%) to limit the thermal stress on the transient load circuit. Switch the jumper resistors R34 or R35 (on the backside of boards) to apply load transient on channel 1 or channel 2 correspondingly.
- (Optional) LTM4650-1 can be synchronized to an external clock signal. Place the JP1 jumper on EXT\_CLK and apply a clock signal (0V ~ 5V, square wave) on the CLKIN test point.
- (Optional) The outputs of LTM4650-1 can track another supply. The jumpers JP4 and JP5 allow choosing soft-start or output tracking. If tracking external voltage is selected, the corresponding test points, TRACK1 and TRACK2, need to be connected to a valid voltage signal.
- (Optional) LTM4650-1 can be configured for a 2-phase single output at up to 50A on DC2378A-B. Install 0Ω resistors on R14, R17, R28, R39, R43, R44, R45 and remove R7, R19. Output voltage is set by R25 based on equation V<sub>OUT</sub> = 0.6V(1 + 60.4k/R25).

dc2378abfa

QUICK START PROCEDURE

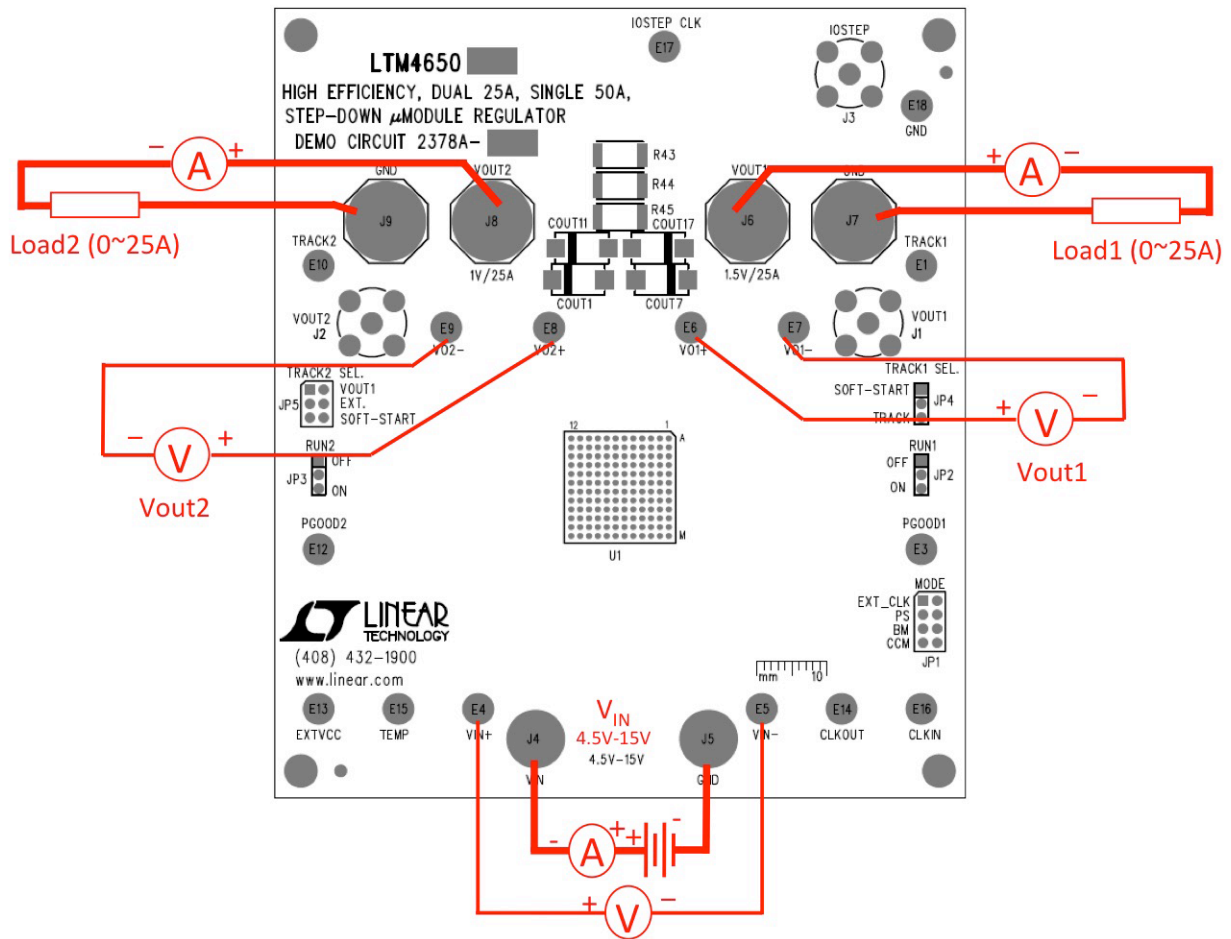

Figure 2. Test Setup of DC2378A-B

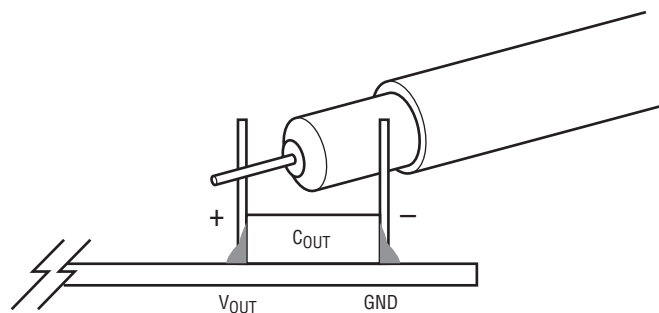

Figure 3. Measuring Output Voltage Ripple

## QUICK START PROCEDURE

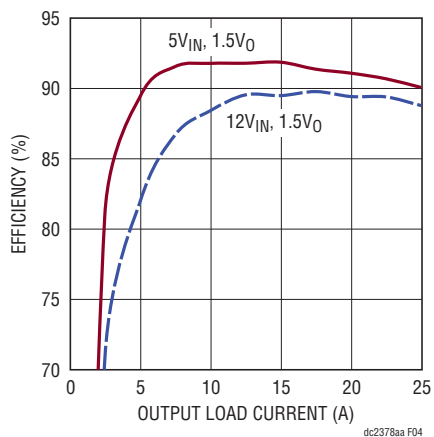

Figure 4. Measured Efficiency on Channel 1 ( $V_{OUT1} = 1.5V$ ,  $f_{SW} = 500kHz$ , Channel 2 Disabled)

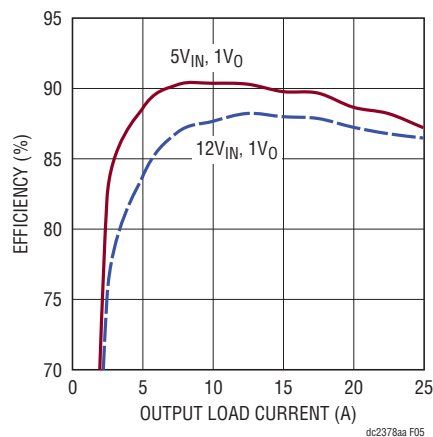

Figure 5. Measured Efficiency on Channel 2 ( $V_{OUT2} = 1V$ ,  $f_{SW} = 500kHz$ , Channel 1 Disabled)

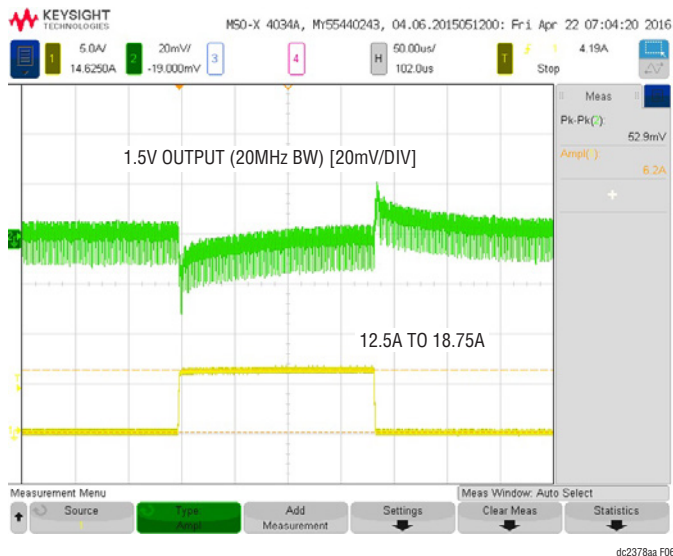

Figure 6. Measured Channel 1 12.5A to 18.75A Load Transient ( $V_{IN} = 12V$ ,  $V_{OUT1} = 1.5V$ )

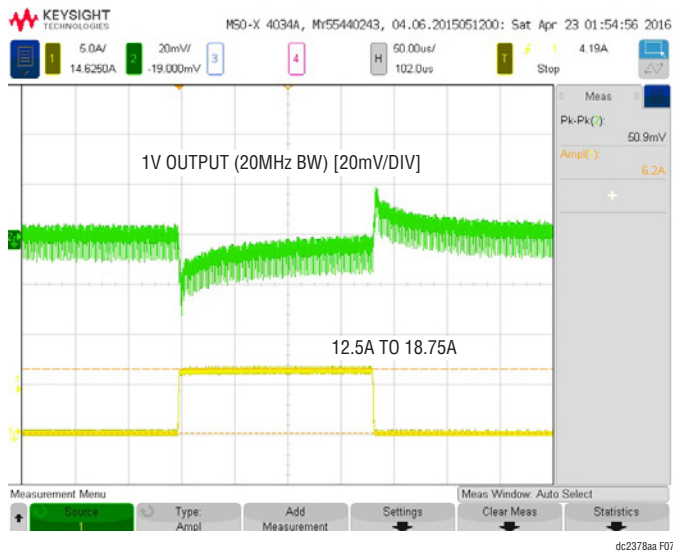
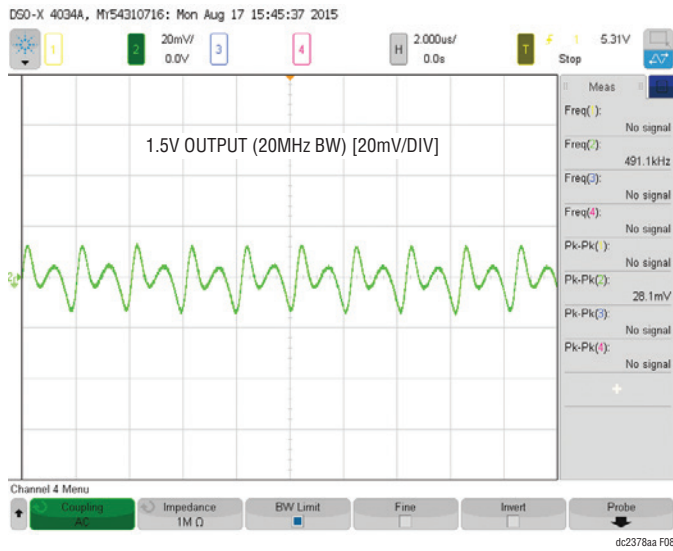
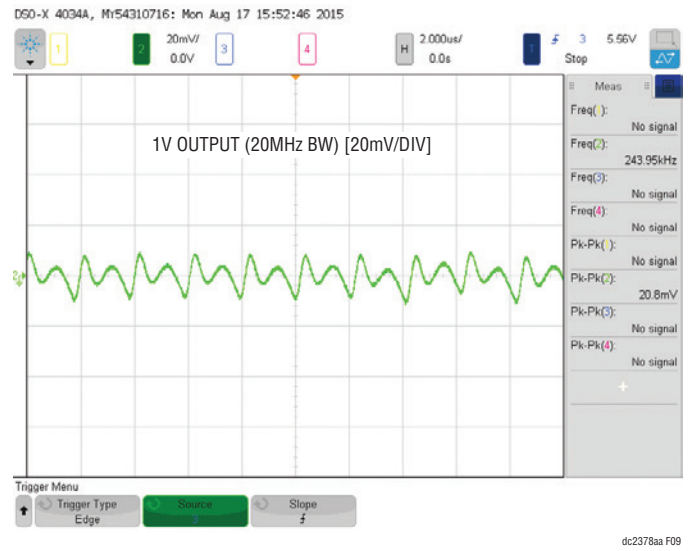

Figure 7. Measured Channel 2 12.5A to 18.75A Load Transient ( $V_{IN} = 12V$ ,  $V_{OUT2} = 1V$ )

**QUICK START PROCEDURE**



**Figure 8. Measured Output Voltage Ripple at 12V Input, 1.5V/25A with Standard Demo Circuit Default Setup**



**Figure 9. Measured Output Voltage Ripple at 12V Input, 1V/25A with Standard Demo Circuit Default Setup**

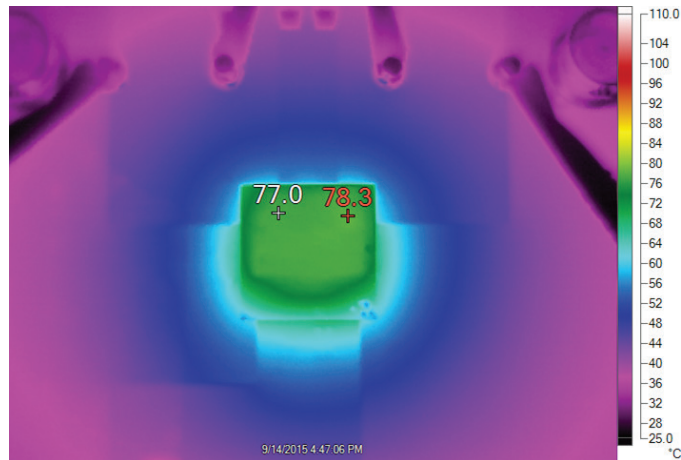

**Figure 10. Thermal Capture at 12V<sub>IN</sub>, 1.5V<sub>OUT</sub> at 25A and 1V<sub>OUT</sub> at 25A (Ambient Temperature = 23°C, 200 LFM Airflow and No Heat Sink)**

# DEMO MANUAL DC2378A-B

## PARTS LIST

ITEM	QTY	REFERENCE	PART DESCRIPTION	MANUFACTURER/PART NUMBER
<b>Required Circuit Components</b>				
1	1	CIN1	CAP., ALUM. ELECT.,330µF, 25V, 20%	PANASONIC, 25SVPF330M
2	4	CIN2, CIN3, CIN4, CIN5	CAP., 22µF,X5R, 25V, 10%,1210	MURATA, GRM32ER61E226KE15L
3	4	COU9, COU10, COU12, COU18	CAP., POSCAP, 470µF, 2.5V, 0.005Ω, 7343	PANASONIC, ETPF470M5H
4	10	COU2, COU3, COU4, COU5, COU6 COU8, COU13, COU14, COU15, COU16	CAP., 100µF, X5R, 6.3V, 20%, 1210	AVX, 12106D107MAT2A
5	1	C1	CAP., 4.7µF, X5R, 16V,20%, 0805	KEMET, C0805C475M4PACTU
6	1	C2	CAP., 1µF,X7R, 25V,10%, 0805	AVX, 08053C105KAT2A
7	2	C5, C7	CAP., 0.1µF, X5R, 25V, 10%, 0603	AVX, 06033D104KAT2A
8	1	C10	CAP., 220pF, X7R, 100V,10%, 0603	AVX, 06031C221KAT2A
9	1	C12	CAP., 47pF, X7R, 50V,10%, 0603	AVX, 06035A470J4T2A
10	4	C13, C14, C15, C16	CAP., 1µF, X7R, 10V,10%, 0603	AVX, 0603ZC105KAT2A
11	1	C17	CAP., 3.3nF, X7R, 50V,10%, 0603	AVX, 06035C332KAT2A
12	1	C18	CAP., 4.7nF, X7R, 50V,10%, 0603	AVX, 06035C472KAT2A
13	1	Q1	XSTR., N-CH, 40V, DPAK-2, TO-252	VISHAY, SUD50N04-8M8P-4GE3
14	4	R1, R3, R22, R26	RES., 10 OHMS, 1/10W, 1%, 0603	NIC, NRC06F10R0TRF
15	1	R5	RES., 100k, 1/10W, 1%, 0603	VISHAY,CRCW0603100KFKEA
16	4	R9, R12, R15, R18	RES., 60.4k, 1/10W,1%, 0603	VISHAY, CRCW060360K4FKEA
17	2	R10, R13	RES., 6.04k, 1/10W,1%, 0603	VISHAY, CRCW06036K04FKEA
18	1	R19	RES., 90.9k, 1/10W,1%, 0603	VISHAY, CRCW060390K9FKEA
19	3	R24, R27, R36	RES., 10k, 1/10W,1%, 0603	YAGEO, RC0603FR-0710KL
20	1	R25	RES., 40.2k, 1/10W,1%, 0603	VISHAY,CRCW060340K2FKEDA
21	1	R30	RES., 121k, 1/10W,1%, 0603	VISHAY,CRCW0603121KFKEA
22	1	R37	RES., HIGH POWER, 0.01Ω, 2W,1%, 2512	VISHAY, WSL2512R0100FEA18
23	1	R46	RES., 21k, 1/10W,1%, 0603	YAGEO, RC0603FR-0721KL
24	1	R47	RES., 20k, 1/10W,1%, 0603	YAGEO, RC0603FR-0720KL
25	1	U1	I.C., 16X16X5.01-BGA	LINEAR TECH., LTM4650EY-1#PBF
<b>Additional Demo Board Circuit Components</b>				
1	0	COU1, COU7, COU11, COU17	CAP., OPT, 7343	OPT
2	0	C3, C4, C6, C8, C9, C11	CAP., OPTION, 0603	OPT
3	0	R2, R4, R6, R8, R11, R14, R16, R17, R20, R23, R28, R31, R33, R39, R40, R41, R42, R48	RES., OPTION, 0603	OPT
4	4	R7, R21, R29, R32	RES., 0Ω, 1/10W, 0603	VISHAY, CRCW06030000Z0EA
5	1	R34	RES., 0Ω, 1/2W, 2010	VISHAY, CRCW20100000Z0EF
6	0	R35	RES., OPTION, 2010	OPT
7	0	R38, R43, R44, R45	RES., OPTION, 2512	OPT
<b>Hardware: For Demo Board Only</b>				
1	16	E1, E3, E4, E5, E6, E7, E8, E9, E10, E12, E13, E14, E15, E16, E17, E18	TEST POINT, TURRET, .094" MTG. HOLE	MILL-MAX, 2501-2-00-80-00-00-07-0
2	1	JP1	CONN., HEADER, 2x4, 2mm	WURTH ELEKTRONIK, 62000821121
3	3	JP2, JP3, JP4	CONN., HEADER, 1x3, 2mm	WURTH ELEKTRONIK, 62000311121

dc2378abfa

## PARTS LIST

ITEM	QTY	REFERENCE	PART DESCRIPTION	MANUFACTURER/PART NUMBER
4	1	JP5	CONN., HEADER, 2x3, 2mm	WURTH ELEKTRONIK, 62000621121
5	5	XJP1, XJP2, XJP3, XJP4, XJP5	SHUNT, 2mm	WURTH ELEKTRONIK, 60800213421
6	3	J1, J2, J3	CONN., BNC STR PCB JK, THRU- HOLE, 5 PINS	CONNEX 112404
7	2	J4, J5	CONN., JACK, BANANA, NON-INSULATED, 0.218"	KEystone, 575-4
8	4	J6, J7, J8, J9	STUD, TESTPIN	PEM KFH-032-10
9	8	J6, J7, J8, J9 (x2)	NUT, BRASS 10-32	ANY #10-32
10	4	J6, J7, J8, J9	RING, LUG #10	KEystone, 8205, #10
11	4	J6, J7, J8, J9	WASHER, TIN PLATED BRASS	ANY #10, #10EXT BZ TN
12	4	(STAND-OFF)	STANDOFF, NYLON, SNAP-ON, 0.500"	KEystone, 8833

# DEMO MANUAL DC2378A-B

## SCHEMATIC DIAGRAM

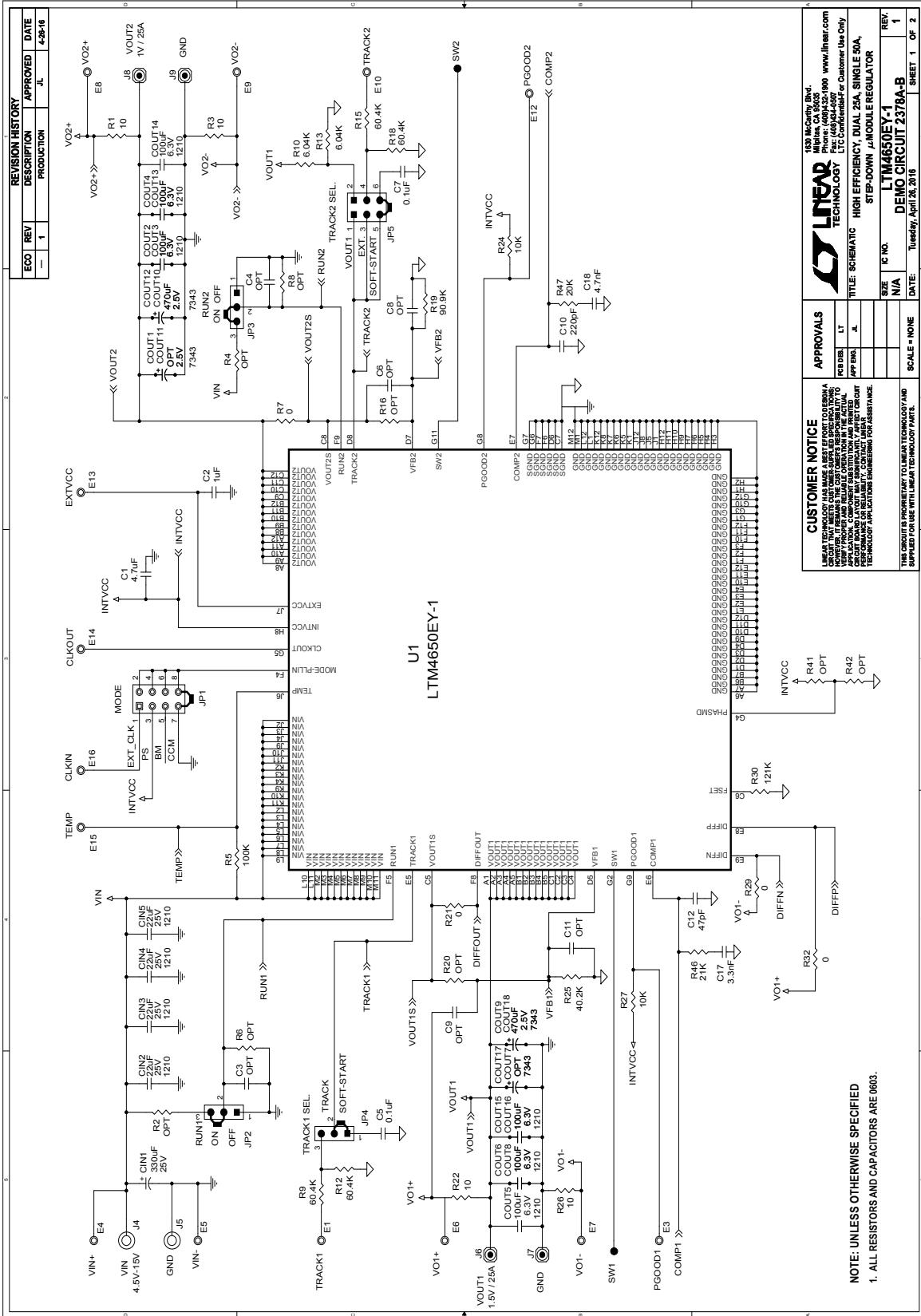

**CUSTOMER NOTICE**  
 LTM4650EY-1 is a demo circuit. It is not intended for use in a final product. It is provided as a reference only. The actual circuit board layout may differ from the schematic. For more information, please contact your local sales office.

**APPROVALS**  
 PERIOD: LT  
 DATE: .  
 SCALE: NONE

**LINEAR TECHNOLOGY**  
 1630 McCarthy Blvd.  
 Milpitas, CA 95035  
 Phone: 415/964-9600 www.linear.com  
 Fax: 415/964-2200  
 LTM4650EY-1 is a demo circuit. It is not intended for use in a final product. It is provided as a reference only.

**TITLE: SCHEMATIC HIGH EFFICIENCY, DUAL 25A, SINGLE 50A, STEP-DOWN, μMODULE REGULATOR**

REV: 1  
 SHEET 1 OF 2

NOTE: UNLESS OTHERWISE SPECIFIED  
 1. ALL RESISTORS AND CAPACITORS ARE 0603.



**SCHEMATIC DIAGRAM**

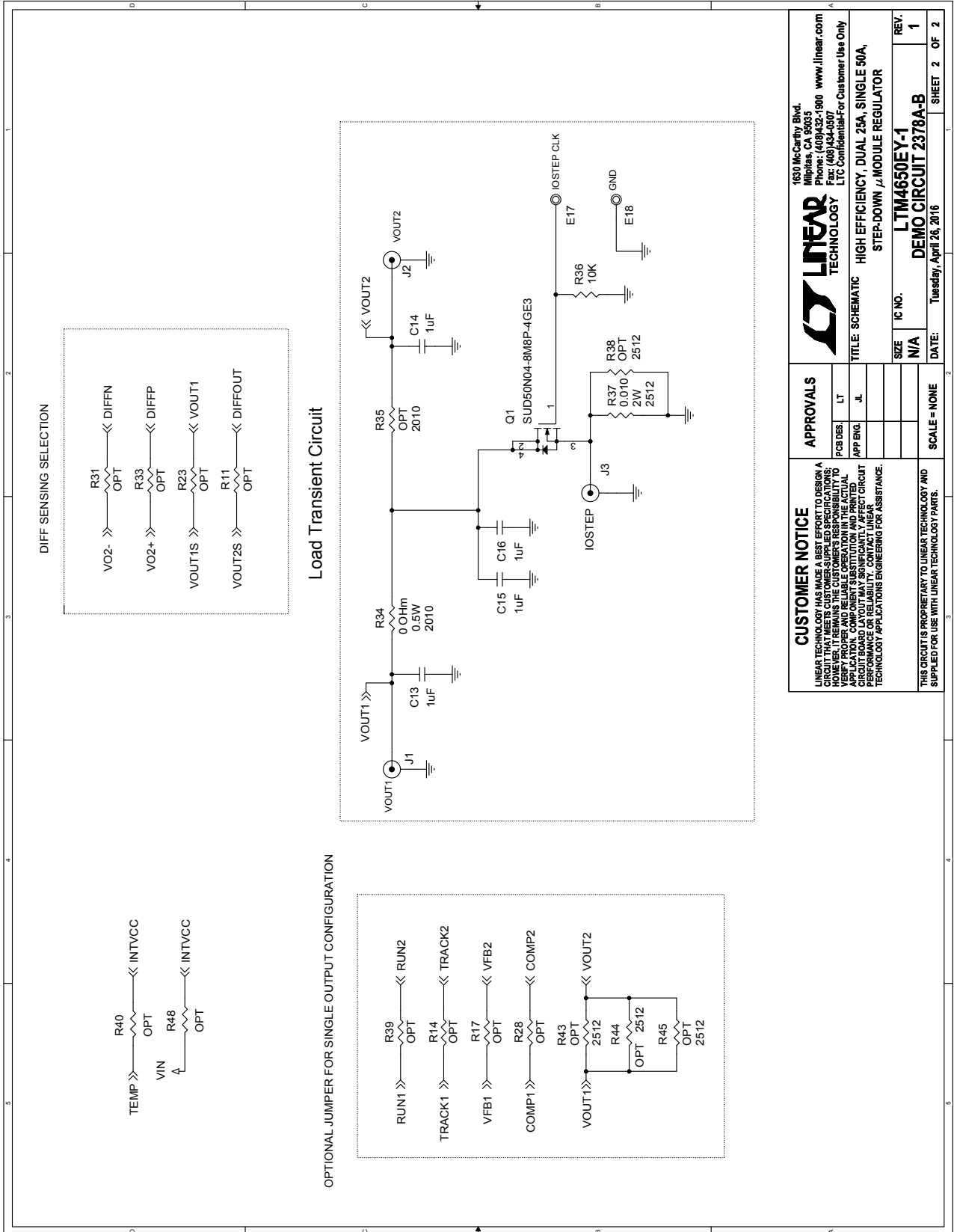

**LINER TECHNOLOGY**  
 1630 McCarthy Blvd.  
 Milpitas, CA 95035  
 Phone: (408)432-1900 www.linear.com  
 Fax: (408)434-0507  
 LTC Confidential-For Customer Use Only

**TITLE: SCHEMATIC HIGH EFFICIENCY, DUAL 25A, SINGLE 50A, STEP-DOWN  $\mu$ MODULE REGULATOR**

**IC NO. LTM4650EY-1**  
**REV. 1**

**DATE: Tuesday, April 26, 2016**

**SCALE = NONE**

**SHEET 2 OF 2**

**CUSTOMER NOTICE**  
 LINER TECHNOLOGY HAS MADE A BEST EFFORT TO DESIGN A CIRCUIT THAT WILL OPERATE AS DESCRIBED IN THIS MANUAL. HOWEVER, IT REMAINS THE CUSTOMER'S RESPONSIBILITY TO VERIFY PROPER AND RELIABLE OPERATION IN THE ACTUAL APPLICATION. COMPONENT SUBSTITUTION AND PRINTED CIRCUIT BOARD MANUFACTURING VARIATIONS MAY AFFECT CIRCUIT PERFORMANCE OR RELIABILITY. CONTACT LINER TECHNOLOGY APPLICATIONS ENGINEERING FOR ASSISTANCE.

**APPROVALS**

PCB DES.	LT
APP ENG.	JL

**THIS CIRCUIT IS PROPRIETARY TO LINER TECHNOLOGY AND SUPPLIED FOR USE WITH LINER TECHNOLOGY PARTS.**

# DEMO MANUAL DC2378A-B

---

## DEMONSTRATION BOARD IMPORTANT NOTICE

Linear Technology Corporation (LTC) provides the enclosed product(s) under the following **AS IS** conditions:

This demonstration board (DEMO BOARD) kit being sold or provided by Linear Technology is intended for use for **ENGINEERING DEVELOPMENT OR EVALUATION PURPOSES ONLY** and is not provided by LTC for commercial use. As such, the DEMO BOARD herein may not be complete in terms of required design-, marketing-, and/or manufacturing-related protective considerations, including but not limited to product safety measures typically found in finished commercial goods. As a prototype, this product does not fall within the scope of the European Union directive on electromagnetic compatibility and therefore may or may not meet the technical requirements of the directive, or other regulations.

If this evaluation kit does not meet the specifications recited in the DEMO BOARD manual the kit may be returned within 30 days from the date of delivery for a full refund. **THE FOREGOING WARRANTY IS THE EXCLUSIVE WARRANTY MADE BY THE SELLER TO BUYER AND IS IN LIEU OF ALL OTHER WARRANTIES, EXPRESSED, IMPLIED, OR STATUTORY, INCLUDING ANY WARRANTY OF MERCHANTABILITY OR FITNESS FOR ANY PARTICULAR PURPOSE. EXCEPT TO THE EXTENT OF THIS INDEMNITY, NEITHER PARTY SHALL BE LIABLE TO THE OTHER FOR ANY INDIRECT, SPECIAL, INCIDENTAL, OR CONSEQUENTIAL DAMAGES.**

The user assumes all responsibility and liability for proper and safe handling of the goods. Further, the user releases LTC from all claims arising from the handling or use of the goods. Due to the open construction of the product, it is the user's responsibility to take any and all appropriate precautions with regard to electrostatic discharge. Also be aware that the products herein may not be regulatory compliant or agency certified (FCC, UL, CE, etc.).

No License is granted under any patent right or other intellectual property whatsoever. **LTC assumes no liability for applications assistance, customer product design, software performance, or infringement of patents or any other intellectual property rights of any kind.**

LTC currently services a variety of customers for products around the world, and therefore this transaction **is not exclusive**.

**Please read the DEMO BOARD manual prior to handling the product.** Persons handling this product must have electronics training and observe good laboratory practice standards. **Common sense is encouraged.**

This notice contains important safety information about temperatures and voltages. For further safety concerns, please contact a LTC application engineer.

Mailing Address:

Linear Technology  
1630 McCarthy Blvd.  
Milpitas, CA 95035

Copyright © 2004, Linear Technology Corporation