

### WDU18-300

#### Electrical Specifications (@25C)

1. Primary Rating: 120V 60Hz 9W
2. Primary Excitation Current: 75mA Max
3. Secondary Rating: 18VDC  $\pm$  5%, 300mADC
4. Secondary No-Load Rating: 24.20VDC Ref.
5. Output Ripple Voltage: 1280mV Max
6. Operating Temperature Range: -10 Deg C to +40 Deg C
7. Temperature Rise: 75 Deg C Max at rated load  
50 Deg C Max on enclosure surface

#### Mechanical Parameters:

Case Type: Thermoplastic molded enclosure.  
Output Cord: 24 AWG, 6 Ft. Long Min.

Agency File:

UL/CUL: File E245587, UL 1310

#### A. Dimensions:

H	W	D
70	50	41

\*Units: In Millimeter

#### B. Schematic:

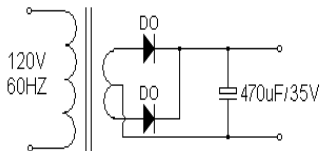

Technical Note: 1. Inside (tip)-positive (+), outside-negative (-)

**U.S. DOE Compliance per Sec. 301 of EISA 2007:** As of July 1, 2008, this product is intended for use as follows:

1. Requires Federal Food and Drug Administration listing and approval as a medical device in accordance with section 513 of the Federal Food, Drug, and Cosmetic Act (21 U.S.C. 360c)
2. Powers the charger of a detachable battery pack or charges the battery of a product that is fully or primarily motor operated.
3. As a service part or a spare part for an end-use product manufactured before July 1, 2008, that constitutes the primary load of this power supply.

**RoHS Compliance:** As of manufacturing date February 2005, all standard products meet the requirements of 2011/65/EU, known as the RoHS initiative.

\* Upon printing, this document is considered "uncontrolled". Please contact Triad Magnetics' website for the most current version.

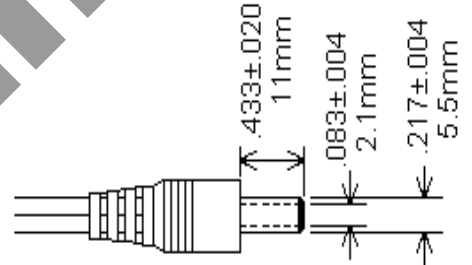
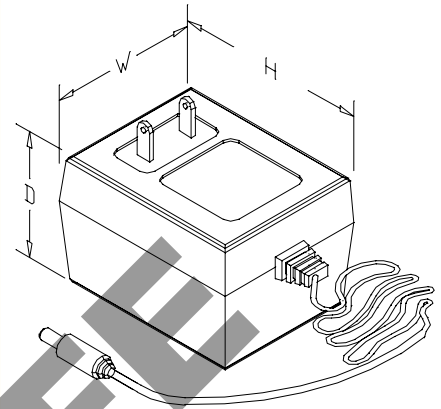

#### NAMEPLATE MARKING

