

## Grove - Electricity Sensor

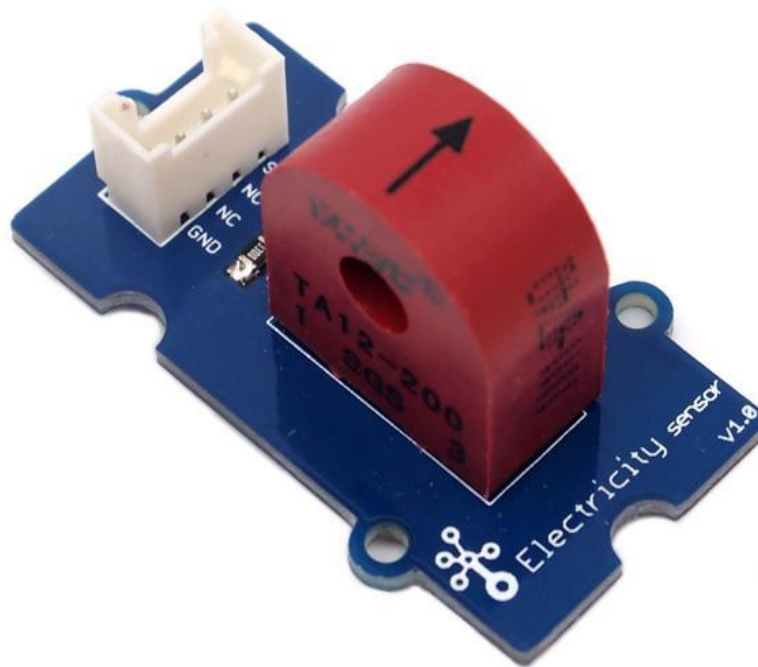

The Electricity sensor module is a member of Grove. It is based on the TA12-200 current transformer which can transform the large AC into small amplitude. You can use it to test large alternating current up to 5A.

### Features

- Grove compatible interface
- Maximum 5A input
- High accuracy
- Small size

### Tip

More details about Grove modules please refer to Grove System

## Application Ideas

- Alternating current measurement
- Device condition monitoring

## Specification





### Key Specification

| Items        | Min                    |
|--------------|------------------------|
| PCB Size     | 2.0cm*4.0cm            |
| Interface    | 2.0mm pitch pin header |
| IO Structure | SIG,NC,NC,GND          |
| RoHS         | YES                    |

### Electronic Characteristics

| Items                 | Min | Norm   | Max  | Unit      |
|-----------------------|-----|--------|------|-----------|
| Transformation ratio  | -   | 2000:1 | -    | -         |
| Input Current         | 0   | -      | 5    | A         |
| Output Current        | 0   | -      | 2.5  | mA        |
| Sampling Resistance   | -   | 800    | -    | Ω         |
| Sampling Voltage      | 0   | -      | 2    | V         |
| Working Frequency     | 20  | -      | 20K  | HZ        |
| Nonlinear scale       | -   | -      | 0.2% | -         |
| Phase Shift           | -   | -      | 5'   | -         |
| Operating Temperature | -55 | -      | 85   | °C        |
| Dielectric strength   | -   | 6      | -    | KVAC/1min |

## Platforms Supported

| Arduino   | Raspberry Pi  | BeagleBone  | Wio  | LinkIt ONE  |
|---|---|---|--|---|
|  |  |  |  |  |

### Caution

The platforms mentioned above as supported is/are an indication of the module's hardware or theoretical compatibility. We only provide software library or code examples for Arduino platform in most cases. It is not possible to provide software library / demo code for all possible MCU platforms. Hence, users have to write their own software library.

## Usage

### With Arduino

The following sketch demonstrates a simple application of measuring the amplitude of the alternating voltage. The SIG pin will output a alternating voltage based on the alternating current being measured. You can measure the value using ADC.

- Connect the module to the analog A0 of Grove - Base board.
- Put the alternating current wire through the hole of the current transformer.

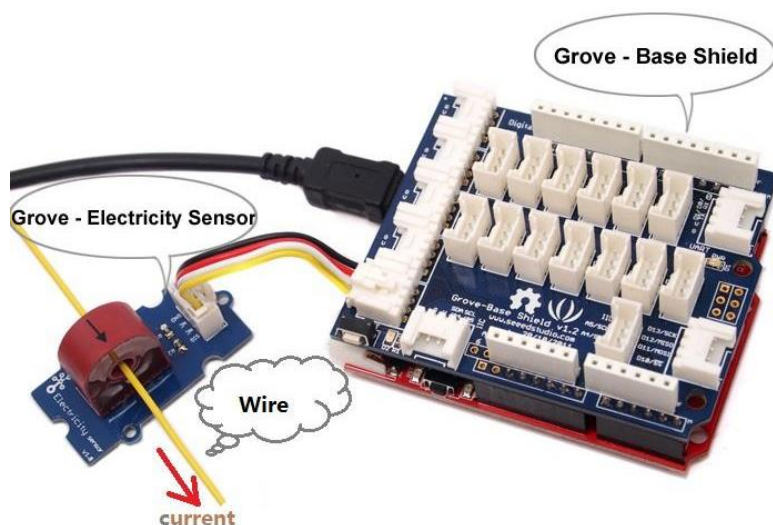

- Copy and paste code below to a new Arduino sketch.

```

/*****
// Function: Measure the amplitude current of the alternating current and
//           the effective current of the sinusoidal alternating current.
// Hardware: Grove - Electricity Sensor
// Date:   Jan 19,2013
// by www.seeedstudio.com
#define ELECTRICITY_SENSOR A0 // Analog input pin that sensor is attached to

float amplitude_current;      //amplitude current
float effective_value;        //effective current

void setup()
{
  Serial.begin(9600);
  pins_init();
}
void loop()
{
  int sensor_max;
  sensor_max = getMaxValue();
  Serial.print("sensor_max = ");
  Serial.println(sensor_max);
  //the VCC on the Grove interface of the sensor is 5v
  amplitude_current=(float)sensor_max/1024*5/800*2000000;
  effective_value=amplitude_current/1.414;//minimum_current=1/1024*5/800*2000000/1.414=8.6(mA)
  //Only for sinusoidal alternating current
  Serial.println("The amplitude of the current is(in mA)");
  Serial.println(amplitude_current,1);//Only one number after the decimal point
  Serial.println("The effective value of the current is(in mA)");
  Serial.println(effective_value,1);
}
void pins_init()
{
  pinMode(ELECTRICITY_SENSOR, INPUT);
}
/*Function: Sample for 1000ms and get the maximum value from the SIG pin*/
int getMaxValue()
{
  int sensorValue;          //value read from the sensor
  int sensorMax = 0;
  uint32_t start_time = millis();
  while((millis()-start_time) < 1000)//sample for 1000ms
  {
    sensorValue = analogRead(ELECTRICITY_SENSOR);
    if (sensorValue > sensorMax)
    {
      /*record the maximum sensor value*/
      sensorMax = sensorValue;
    }
  }
  return sensorMax;
}

```

- Upload the code.

### Note

The minimum effective current that can be sensed by the code can be calculated using the equation below.  $\text{minimum\_current} = 1/1024 * 5/800 * 2000000/1.414 = 8.6(\text{mA})$ .

- Open the serial monitor, The results is as follows :

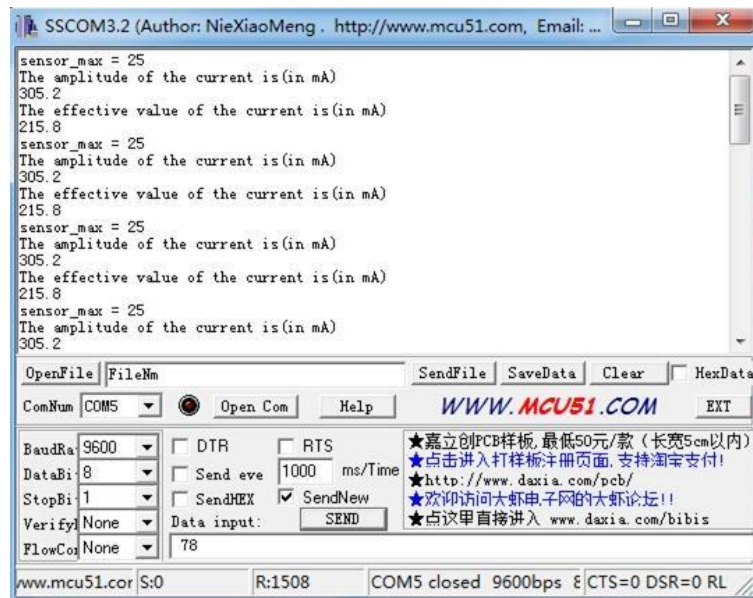

### With Raspberry Pi

- 1.You should have got a raspberry pi and a grovepi or grovepi+.
- 2.You should have completed configuring the development enviroment, otherwise follow here.
- 3.Connection

- Plug the sensor to grovepi socket A0 by using a grove cable.

- 4.Navigate to the demos' directory:

```
cd yourpath/GrovePi/Software/Python/
```

- To see the code

```
nano grove_electricity_sensor.py # "Ctrl+x" to exit #
```

```
import time
import grovepi
```

```
# Connect the Grove Electricity Sensor to analog port A0
# SIG,NC,NC,GND
```

```
sensor = 0
```

```
grovepi.pinMode(sensor,"INPUT")
```

```
# Vcc of the grove interface is normally 5v
```

```
grove_vcc = 5
```

```
while True:
```

```
    try:
```

```
        # Get sensor value
```

```
        sensor_value = grovepi.analogRead(sensor)
```

```
        # Calculate amplitude current (mA)
```

```
        amplitude_current = (float)(sensor_value / 1024 * grove_vcc / 800 * 2000000)
```

```
        # Calculate effective value (mA)
```

```
        effective_value = amplitude_current / 1.414
```

```
        # minimum_current = 1 / 1024 * grove_vcc / 800 * 2000000 / 1.414 = 8.6(mA)
```

```
        # Only for sinusoidal alternating current
```

```
        print "sensor_value", sensor_value
```

```
        print "The amplitude of the current is", amplitude_current, "mA"
```

```
        print "The effective value of the current is", effective_value, "mA"
```

```
        time.sleep(1)
```

```
    except IOError:
```

```
        print "Error"
```

5.Run the demo.

```
sudo python grove_electricity_sensor.py
```

Resources

---

- Grove -Electricity Sensor Eagle File
- Schematic in PDF

## Tech Support

Please do not hesitate to contact [techsupport@seeed.cc](mailto:techsupport@seeed.cc) if you have any technical issue. Or submit the issue into our forum.